

OWNER'S MANUAL

2025 AFRICA TWIN

This manual should be considered a permanent part of the vehicle and should remain with the vehicle when it is resold.

This publication includes the latest production information available before printing. Honda Motor Co., Ltd. reserves the right to make changes at any time without notice and without incurring any obligation.

No part of this publication may be reproduced without written permission.

The vehicle pictured in this owner's manual may not match your actual vehicle.

CRF1100D is USA model only.

Welcome

Congratulations on your purchase of a new Honda vehicle. Your selection of a Honda makes you part of a worldwide family of satisfied customers who appreciate Honda's reputation for building quality into every product.

To ensure your safety and riding pleasure:

- Read this owner's manual carefully.
- Follow all recommendations and procedures contained in this manual.
- Pay close attention to safety messages contained in this manual and on the vehicle.

To protect your investment, we urge you to take responsibility for keeping your vehicle well-serviced and maintained. Also, observe the break-in guidelines and always perform the pre-ride inspection and other periodic checks in this manual.

When service is required, remember that your Honda dealer knows your vehicle best. If you have the required mechanical "know-how" and tools, you can purchase an official Honda Service Manual to help you perform many maintenance and repair tasks. ➔ P. 356
Read the warranty information thoroughly so that you understand the warranty coverage and are aware of your rights and responsibilities. ➔ P. 357

You may also want to visit our website at www.powersports.honda.com.

Canada www.honda.ca.

Happy riding!

A Few Words About Safety

Your safety, and the safety of others, is very important. Operating this vehicle safely is an important responsibility.

To help you make informed decisions about safety, we have provided operating procedures and other information on safety labels and in this manual. This information alerts you to potential hazards that could hurt you or others.

Of course, it is not practical or possible to warn you about all hazards associated with operating or maintaining a vehicle. You must use your own good judgment.

You will find important safety information in a variety of forms, including:

- Safety labels on the vehicle
- Safety Messages preceded by a safety alert symbol  and one of three signal words: DANGER, WARNING, or CAUTION.

These signal words mean:

DANGER

You **WILL** be **KILLED** or **SERIOUSLY HURT** if you don't follow instructions.

WARNING

You **CAN** be **KILLED** or **SERIOUSLY HURT** if you don't follow instructions.

CAUTION

You **CAN** be **HURT** if you don't follow instructions.

Other important information is provided under the following titles:

NOTICE Information to help you avoid damage to your vehicle, other property, or the environment.

Contents

Vehicle Safety P. 2

Operation Guide P. 18

Maintenance P. 242

Troubleshooting P. 305

Information P. 335

Specifications P. 369

Vehicle Safety

This section contains important information for safe riding of your vehicle.
Please read this section carefully.

Safety Guidelines	P. 3
Safety Labels	P. 8
Safety Precautions	P. 10
Riding Precautions	P. 11
Accessories & Modifications	P. 15
Off-Road Safety	P. 16
Loading	P. 17

Safety Guidelines

Follow these guidelines to enhance your safety:

- Perform all routine and regular inspections specified in this manual.
- Stop the engine and keep sparks and flames away before filling the fuel tank.
- Do not run the engine in enclosed or partly enclosed areas. Carbon monoxide in exhaust gases is toxic and can kill you.

Always Wear a Helmet

It's a proven fact: helmets and protective apparel significantly reduce the number and severity of head and other injuries. So always wear an approved helmet and protective apparel. 📄 P. 10

Before Riding

Make sure that you are physically fit, mentally focused, and free of alcohol and drugs. Check that you and your passenger are both wearing an approved helmet and protective apparel. Instruct your passenger on holding onto the grab rail or your waist, leaning with you in turns, and keeping their feet on the footpegs, even when the vehicle is stopped.

Take Time to Learn & Practice

Even if you have ridden other vehicles, practice riding in a safe area to become familiar with how this vehicle works and handles, and to become accustomed to the vehicle's size and weight.

Safety Guidelines

We recommend that all riders take a certified course approved by the Motorcycle Safety Foundation (MSF) or a state approved training course. New riders should start with the basic course, and even experienced riders will find the advanced course beneficial.

For information about the MSF training course nearest you, call the national toll-free number: (800) 446-9227.

USA Other riding tips can be found in the You and Your Motorcycle Riding Tips booklet that came with your vehicle.

Developing off-road riding skill is a gradual step-by step process. Start by practicing at low speeds in a safe area and slowly build your skills.

Ask your dealer if there are off-road riding groups in your area where you can learn from experienced riders. Also be sure to read the Tips & Practice Guide for the Off-Highway Motorcyclist that came with your new vehicle.

Ride Defensively

Always pay attention to other vehicles around you, and do not assume that other drivers see you. Be prepared to stop quickly or perform an evasive maneuver.

Make Yourself Easy to See

Make yourself more visible, especially at night, by wearing bright reflective clothing, positioning yourself so other drivers can see you, signaling before turning or changing lanes, and using your horn when necessary.

Be Alert for Off-road Hazards

The terrain can be present a variety of challenges when you ride off-road. Continually "read" the terrain for unexpected turns, drop-offs, rocks, ruts and other hazards. Always keep your speed low enough to allow time to see and react to hazards.

Ride within Your Limits

Never ride beyond your personal abilities or faster than conditions warrant. Fatigue and inattention can impair your ability to use good judgment and ride safely.

Don't Drink or Use Drugs and Ride

Alcohol or drugs and riding don't mix. Even one alcoholic drink can reduce your ability to respond to changing conditions, and your reaction time gets worse with every additional drink. The same is true for drug use. Don't drink or use and ride, and don't let your friends do it either.

Keep Your Honda in Safe Condition

It's important to keep your vehicle properly maintained and in safe riding condition. Having a breakdown can be difficult, especially if you are stranded off-road far from your base. Inspect your vehicle before every ride and perform all recommended maintenance. Never

exceed load limits (➤ P. 17), and do not modify your vehicle or install accessories that would make your vehicle unsafe (➤ P. 15).

If You are Involved in a Crash

Personal safety is your first priority. If you or anyone else has been injured, take time to assess the severity of the injuries and whether it is safe to continue riding. Call for emergency assistance if needed. Also follow applicable laws and regulations if another person or vehicle is involved in the crash.

If you decide to continue riding, first turn the ignition switch to the OFF position, and evaluate the condition of your vehicle. Inspect for fluid leaks, check the tightness of critical nuts and bolts, and check the handlebar, control levers, brakes, and wheels. Ride slowly and cautiously. Your vehicle may have suffered damage that is not immediately apparent. Have your vehicle thoroughly checked at a qualified service facility as soon as possible.

Lithium-Ion (Li-Ion) Battery

If you smell an unusual odor coming from the lithium-ion (li-ion) battery, park your vehicle in a safe place outside and away from flammable objects, then turn the ignition switch to the OFF position. Have your vehicle inspected by your dealer immediately.

Emergency Shut-down Procedure for Vehicles Equipped with Dual Clutch Transmission

CRF1100D/D4

Unlike standard vehicles, or its manual transmission sibling, the CRF1100D and CRF1100D4 with dual-clutch transmission does not have a clutch lever that would provide you with an additional means to control the engine power being transmitted to the rear wheel. Thus, in the unlikely event that you experience a stuck throttle or other unintended application of power to the rear wheel, you should shut down the engine by use of the engine stop switch (P. 113). By moving this switch to the  (Stop) position, you will immediately stop the engine but maintain all electrical system functions, including lights and indicators.

Carbon Monoxide Hazard

Exhaust contains poisonous carbon monoxide, a colorless, odorless gas. Breathing carbon monoxide can cause loss of consciousness and may lead to death.

If you run the engine in a confined or even partly enclosed area, the air you breathe could contain a dangerous amount of carbon monoxide.

Never run your vehicle inside a garage or other enclosure.

WARNING

Running the engine of your vehicle while in an enclosed or even partially enclosed area can cause a rapid build-up of toxic carbon monoxide gas.

Breathing this colorless, odorless gas can quickly cause unconsciousness and lead to death.

Only run your vehicle's engine when it is located in a well ventilated area outdoors.

Safety Labels

Safety and information labels on your vehicle provide important safety information and may warn you of potential hazards that could cause

serious injury. Read these labels carefully and don't remove them.

If a label comes off or becomes hard to read, contact your dealer for a replacement.

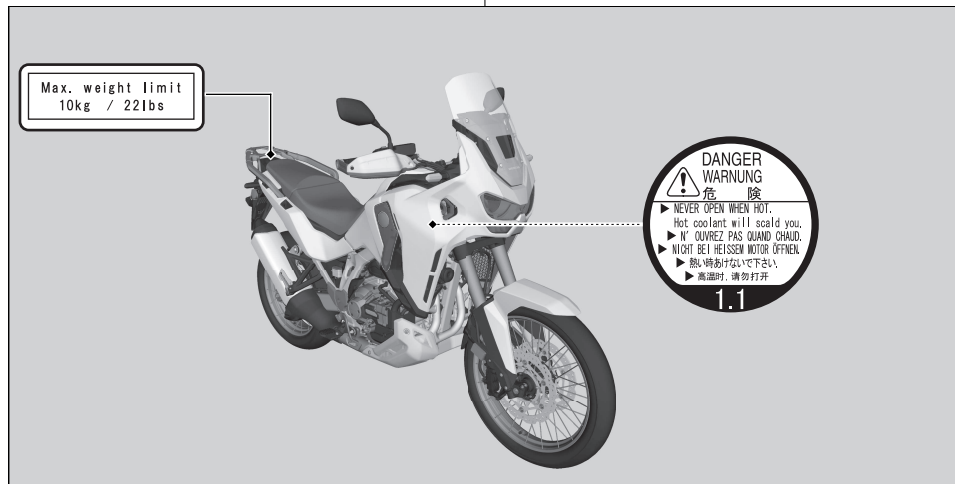

For your protection, always wear your helmet while riding. Read the owner's manual carefully.



⚠ WARNING

Improper loading can cause a crash and you may be seriously hurt or killed. See "Load Limits and Guidelines" in your Owner's Manual for complete instructions.

CRF1100A/D

TIRE INFORMATION			
Cold tire pressures		kPa	kg/cm ² psi
Up to maximum weight capacity	Front	225	2.25 33
	Rear	280	2.80 41
Up to 90kg(200lbs) load	Front	225	2.25 33
	Rear	250	2.50 36
Tire size	Front	90/90-21M/C 54H	
	Rear	150/20R18M/C 70H	
Min. recommend tire center tread depth.	Front	1.5mm (0.06in.)	
Maximum weight capacity	Rear	2.0mm (0.08in.)	
		204kg(450lbs)	

DRIVE CHAIN

Keep chain adjusted and lubricated.



48 - 53mm
(1 7/8 - 2 1/16 in.)

Read owner's manual.

CRF1100A4/D4

TIRE INFORMATION			
Cold tire pressures		kPa	kg/cm ² psi
Up to maximum weight capacity	Front	225	2.25 33
	Rear	280	2.80 41
Up to 90kg(200lbs) load	Front	225	2.25 33
	Rear	250	2.50 36
Tire size	Front	110/80R19M/C 59V	
	Rear	150/20R18M/C 70H	
Min. recommend tire center tread depth.	Front	1.5mm (0.06in.)	
Maximum weight capacity	Rear	2.0mm (0.08in.)	
		204kg(450lbs)	

DRIVE CHAIN

Keep chain adjusted and lubricated.



48 - 53mm
(1 7/8 - 2 1/16 in.)

Read owner's manual.

Safety Precautions

- Ride cautiously and keep your hands on the handlebar and feet on the footpegs.
- Instruct your passenger to keep their hands on the grab rail or your waist and their feet on the footpegs while riding.
- Always consider the safety of your passenger, as well as other drivers and riders.

Protective Apparel

Make sure that you and any passenger are wearing an approved helmet, eye protection, and high-visibility protective clothing. Avoid wearing loose clothes that could get caught on any part of the vehicle. Ride defensively in response to weather and road conditions.

■ Helmet

Should be safety-standard certified, high-visibility, and the correct size for your head.

- Must fit comfortably but securely, with the chin strap fastened
- Face shield with unobstructed field of vision or other approved eye protection

USA Look for a DOT (Department of Transportation) certification label on any helmet you buy.

WARNING

Not wearing a helmet increases the chance of serious injury or death in a crash.

Make sure that you and any passenger always wear an approved helmet and protective apparel.

■ Gloves

Full-finger leather gloves with high abrasion resistance

■ Boots or Riding Shoes

Sturdy boots with non-slip soles and ankle protection

■ Jacket and Pants

Protective, highly visible, long-sleeved jacket and durable long pants for riding (or a protective suit)

■ Additional Off-road Gear

On-road apparel may also be suitable for casual off-road riding. But if you plan on any serious off-road riding you will need more serious off-road gear. In addition to your helmet and eye protection, we recommend off-road motorcycle boots and gloves, riding pants with knee and hip pads, a jersey with elbow pads, and a chest/shoulder protector.

Riding Precautions

Break-in Period

During the first 300 miles (500 km) of running, follow these guidelines to ensure your vehicle's future reliability and performance.

- Avoid full-throttle starts and rapid acceleration.
- Avoid hard braking and rapid down-shifts.
- Ride conservatively.

Brakes

Observe the following guidelines:

- Avoid excessively hard braking and downshifting.
 - ▶ Sudden braking can reduce the vehicle's stability.
 - ▶ Where possible, reduce speed before turning; otherwise you risk sliding out.

Riding Precautions

- Exercise caution on low traction surfaces.
 - ▶ The tires slip more easily on such surfaces and braking distances are longer.
- Avoid continuous braking.
 - ▶ Repeated braking, such as when descending long, steep slopes can seriously overheat the brakes, reducing their effectiveness. Use engine braking with intermittent use of the brakes to reduce speed.
- For full braking effectiveness, operate both the front and rear brakes together.

■ Anti-lock Brake System (ABS)

This model is equipped with an Anti-lock Brake System (ABS) designed to help prevent the brakes from locking up during hard braking. The ABS functions with information provided by the IMU (Inertia Measurement Unit).

- ABS does not reduce braking distance. In certain circumstances, ABS may result in a longer stopping distance.

- ABS does not function at speeds below 6 mph (10 km/h).
- The brake lever and pedal may recoil slightly when applying the brakes. This is normal.
- Always use the recommended front/rear tires and sprockets to ensure correct ABS operation.

■ Engine Braking

Engine braking helps slow your vehicle down when you release the throttle. For further slowing action, downshift to a lower gear. Use engine braking with intermittent use of the brakes to reduce speed when descending long, steep slopes.

■ Wet or Rainy Conditions

Road surfaces are slippery when wet, and wet brakes further reduce braking efficiency. Exercise extra caution when braking in wet conditions.

If the brakes get wet, apply the brakes while riding at low speed to help them dry.

Parking

- Park on a firm, level surface.
- If you must park on a slight incline or loose surface, park so that the vehicle cannot move or fall over.
- Make sure that high-temperature parts cannot come into contact with flammable materials.
- Do not touch the engine, muffler, brakes and other high-temperature parts until they cool down.
- To reduce the likelihood of theft, always lock the handlebar and remove the key when leaving the vehicle unattended. Use of an anti-theft device is also recommended.

■ Parking with the Side Stand

1. Stop the engine.
2. Apply the parking brake. ➤ P. 125
3. Push the side stand down.
4. Slowly lean the vehicle to the left until its weight rests on the side stand.

5. Turn the handlebar fully to the left.
 - ▶ Turning the handlebar to the right reduces stability and may cause the vehicle to fall.
6. Turn the ignition switch to the LOCK position and remove the key. ➤ P. 117

Refueling and Fuel Guidelines

Follow these guidelines to protect the engine, fuel system and catalytic converter:

- Use only unleaded gasoline.
- Use the recommended octane number. Using lower octane gasoline will result in decreased engine performance.
- Do not use fuels containing a high concentration of alcohol. ➤ P. 355
- Do not use stale or contaminated gasoline or an oil/gasoline mixture.
- Avoid getting dirt or water in the fuel tank.

Honda Selectable Torque Control

When the Honda Selectable Torque Control (Torque Control) detects rear wheel spin during acceleration, the system will limit the amount of torque applied to the rear wheel based on the Torque Control level selected.

Additionally, the system eases the rapid motion during a wheelie when accelerating based on the Torque Control level selected.

Torque Control will allow some wheel spin during acceleration at the lower Torque Control setting levels. Select a level that is appropriate for your skill and riding conditions.

Torque Control does not work during deceleration and will not prevent the rear wheel from skidding due to engine braking. Do not close the throttle suddenly, especially when riding on slippery surfaces.

Torque Control may not compensate for rough road conditions or rapid throttle operation.

Always consider road and weather conditions, as well as your skills and condition, when applying throttle.

If your vehicle gets stuck in mud, snow, or sand, it may be easier to free it by turning off the Torque Control temporarily.

Temporarily turning off Torque Control also may help you maintain control and balance when riding on off-road terrain.

Always use the recommended tires and sprockets to ensure correct Torque Control operation.

Accessories & Modifications

We strongly advise that you do not add any accessories that were not specifically designed or approved for your vehicle by Honda or make modifications to your vehicle from its original design. Doing so can make it unsafe. Modifying your vehicle may also void your warranty and make your vehicle illegal to operate on public roads. Before deciding to install accessories on your vehicle, be certain the modification is safe and legal.

WARNING

Improper accessories or modifications can cause a crash in which you can be seriously hurt or killed.

Follow all instructions in this owner's manual regarding accessories and modifications.

Do not pull a trailer with, or attach a sidecar to, your vehicle. Your vehicle was not designed for these attachments, and their use can seriously impair your vehicle's handling.

Off-Road Safety

Learn to ride in an uncongested off-road area free of obstacles before venturing onto unfamiliar terrain.

- Always obey local off-road riding laws and regulations.
- Obtain permission to ride on private property. Avoid posted areas and obey "NO Trespassing" signs.
- Ride with a friend on another vehicle so that you can assist each other in case of trouble.
- Familiarity with your vehicle is critically important should a problem occur far from help.

- Never ride beyond your ability and experience or faster than conditions warrant.
- If you are not familiar with the terrain, ride cautiously. Hidden rocks, holes, or ravines could spell disaster.
- A muffler is required in most off-road areas. Don't modify your exhaust system. Remember that excessive noise bothers everyone and creates a bad image for motorcycling.

Loading

- Carrying extra weight affects your vehicle's handling, braking and stability.
Always ride at a safe speed for the load you are carrying.
- Avoid carrying an excessive load and keep within specified load limits.

Maximum weight capacity / Maximum weight on rear carrier ➤ P. 369

- Tie all luggage securely, evenly balanced, and close to the center of the vehicle.
- Do not place objects near the lights or the muffler.

Also follow these guidelines when you ride off-road on rough terrain:

- Do not carry a passenger.
- Keep cargo small and light weight.
Make sure it cannot easily be caught on brush or other objects, and that it does not interfere with your ability to shift position to maintain balance and stability.

⚠ WARNING

Overloading or improper loading can cause a crash and you can be seriously hurt or killed.

Follow all load limits and other loading guidelines in this manual.

Parts Location

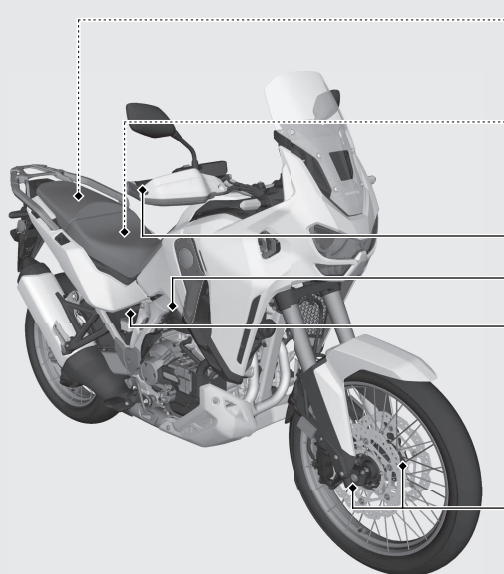

Fuse puller, Hex wrench,
Standard/Phillips screwdriver,
Screwdriver handle ➡ P.240

Document bag ➡ P.239

Throttle grip ➡ P.291

Battery box cover ➡ P.266

Rear suspension compression
damping adjuster
CRF1100A/D ➡ P.301

Front suspension compression
damping adjusters
CRF1100A/D ➡ P.295

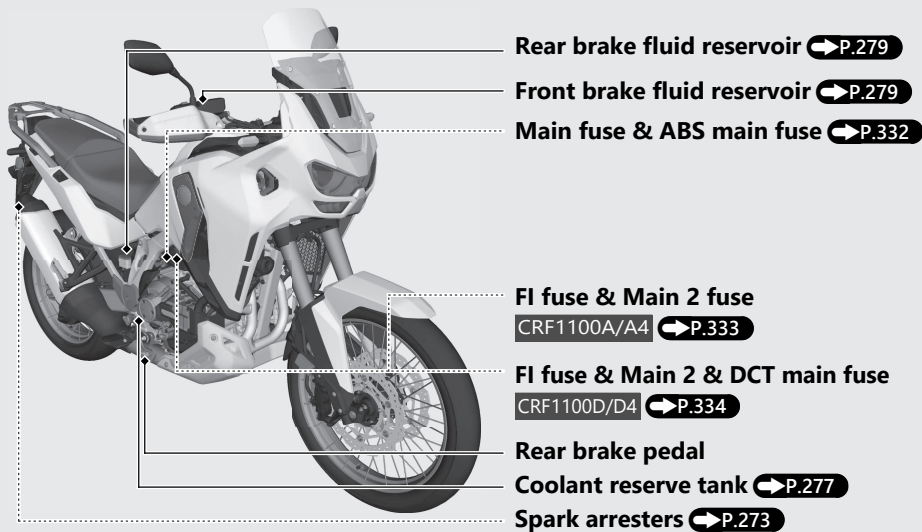

Parts Location *(Continued)*

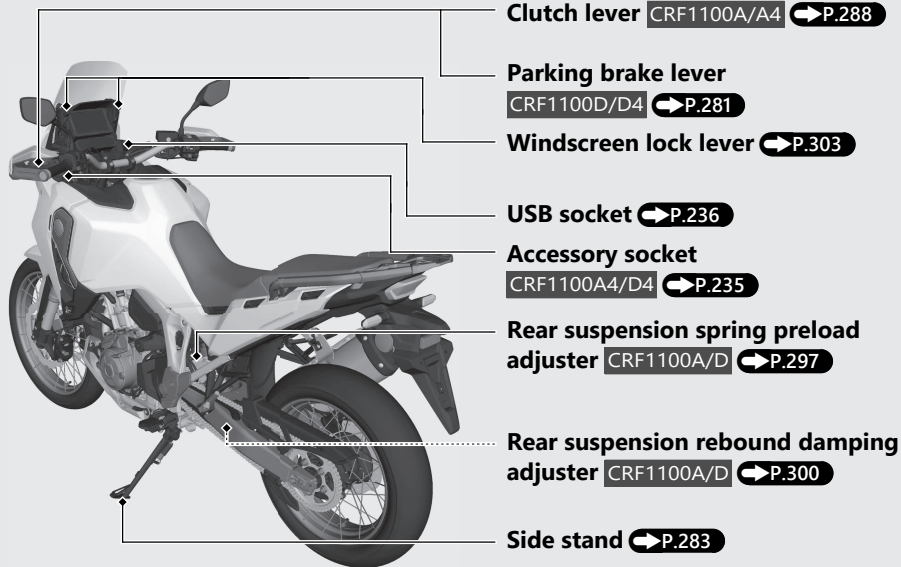

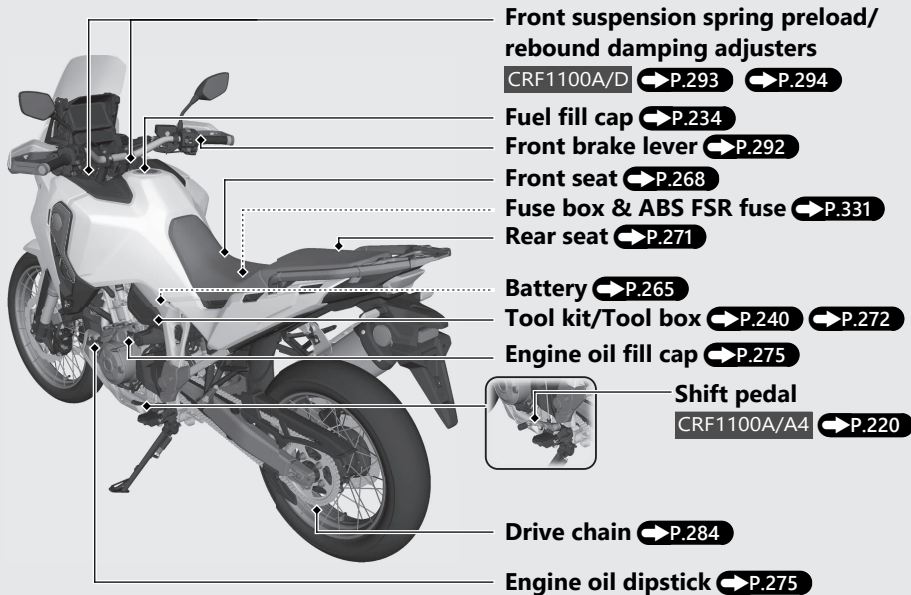

Instruments

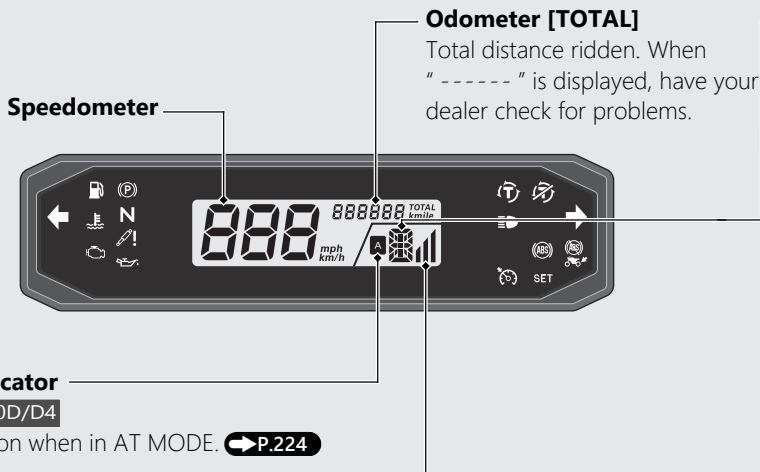

AT indicator

CRF1100D/D4

Comes on when in AT MODE. ➡ P.224

Display Check

When the ignition switch is turned to the ON position, all the mode and digital segments will show. If any part of these displays does not come on when it should, have your dealer check for problems.

Gear position indicator

CRF1100A/A4

The gear position is shown in the gear position indicator.

- ▶ “-” appears when the transmission is not shifted properly.

CRF1100D/D4

The gear position is shown in the gear position indicator when the MT MODE is selected.

The indicator may flash if:

- ▶ The front wheel leaves the ground.
- ▶ You turn the wheel while the vehicle is upright on the stand.

This is normal. To operate the system again, turn the ignition switch to the OFF position, and then to the ON position again.

D is shown in the gear position indicator when the D mode is selected in the AT MODE.

S is shown in the gear position indicator when the S mode is selected in the AT MODE.

If the “-” indicator is blinking in the gear position window while riding: ➡ P.311

S mode level indicator ➡ P.224

CRF1100D/D4

Instruments *(Continued)*

Multi-information display

Your vehicle is equipped with a multi-information display that presents various functions and settings.

The multi-information display is a touch screen. You can operate by touching the screen.

- Certain manual functions and settings are disabled or inoperable while the vehicle is in motion. You cannot select a greyed-out menu until the vehicle is stopped.

When the ignition switch is turned ON, the Notice message appears on the screen for a few seconds.

Read the Notice message, and then press the **ENT** switch or touch [OK] on the screen.

After about 4 seconds, it will switch to the home screen.

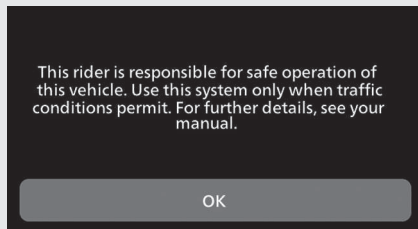

Home Screen

From this screen, you can go to various functions and setup options.

To return to the Home screen: ➔ P.36

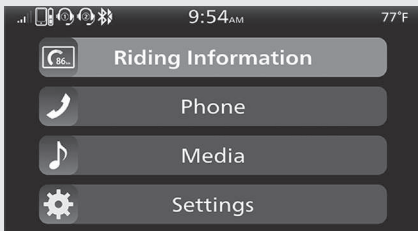

Riding Information

You can go back to the riding information. Riding information has 3 displays, Gold image display, Silver image display and Bronze image display.

These displays are switched according to riding mode.

Gold image display ➔ P.26

Silver image display ➔ P.30

Bronze image display ➔ P.33

To change the display setting on each riding mode ➔ P.78

Phone

You can make calls using a connected *Bluetooth*® audio devices.

Media

You can play music from *Bluetooth*® devices.

Settings

You can select various settings.

Instruments (Continued)

Riding Information

Gold image display

Clock (12-hour or 24-hour display)

To set the clock: ➔ P.87

Riding mode display

➔ P.137

Side stand indicator

➔ P.64

Sub-information indicator

➔ P.39

Cruise Control Set Speed

The speed set for cruise control is displayed.

Cruise Control: ➔ P.228

Air temperature gauge

➔ P.64



Speedometer

Tachometer

NOTICE

Do not operate the engine in the Tachometer red zone.
Excessive engine speed can adversely affect engine life.

Tachometer red zone

(excessive engine rpm range)

Fuel gauge

Remaining fuel when only E (1st) segment starts flashing:

Approximately 0.95 US gal (3.6 L) **CRF1100A/D**

Approximately 1.03 US gal (3.9 L) **CRF1100A4/D4**

If the fuel gauge indicator flashes: ➔ **P.312**



Coolant temperature gauge

When the coolant is over specified temperature, all segments turn red and the H (6th) segment flashes and high coolant temperature indicator lamps. ➔ **P.307**

If the coolant temperature gauge indicator flashes: ➔ **P.313**



Instruments *(Continued)*

Torque Control level [T] indicator P.129

When the indicator flashes, have your dealer check for problems.

[EB] [Engine Brake] level indicator P.137

When the indicator flashes, have your dealer check for problems.

[P] [Power] level indicator P.137

When the indicator flashes, have your dealer check for problems.

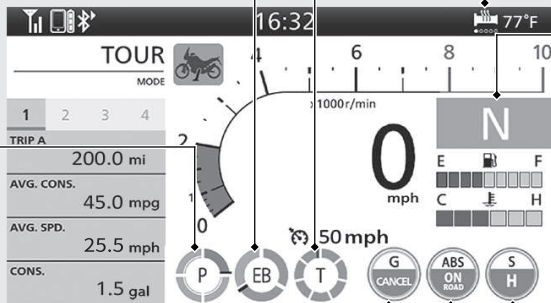

G switch [G] indicator P.122 CRF1100D/D4

When the indicator flashes, have your dealer check for problems.

ABS mode [ABS] indicator P.137

When the indicator flashes, have your dealer check for problems.

[S] [Overall] indicator P.137 CRF1100A4/D4

When the indicator flashes, have your dealer check for problems.

Handle grip heater status icon

CRF1100A4/D4

The handle grip heater status icon will appear while the handle grip heater is on.  **P.128**

If the handle grip heater status icon flashes:  **P.313**

Gear position indicator

CRF1100A/A4

The gear position is shown in the gear position indicator.

- ▶ “-” appears when the transmission is not shifted properly.

CRF1100D/D4

The gear position is shown in the gear position indicator.



The indicator may flash if:

- ▶ The front wheel leaves the ground.
- ▶ You turn the wheel while the vehicle is upright on the stand.

This is normal. To operate the system again, turn the ignition switch to the OFF position, and then to the ON position again.

D is shown in the gear position indicator when the D mode is selected in the AT MODE.

S is shown in the gear position indicator when the S mode is selected in the AT MODE.

 **S mode level indicator**  **P.224**

If the “-” indicator is blinking in the gear position window while riding:  **P.311**

Instruments *(Continued)*

Silver image display

Side stand indicator

➔ P.64

Riding mode display

➔ P.137

Clock (12-hour or 24-hour display)

To set the clock: ➔ P.87

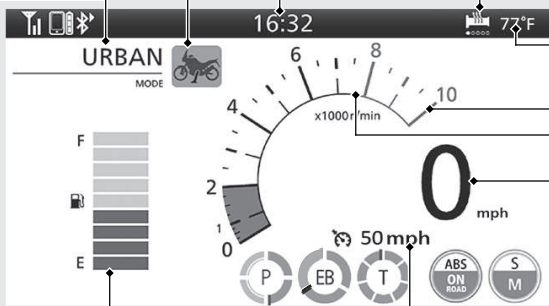

 **Fuel gauge**

Remaining fuel when only E (1st) segment starts flashing:

Approximately 0.95 US gal (3.6 L) **CRF1100A/D**

Approximately 1.03 US gal (3.9 L) **CRF1100A4/D4**

If the fuel gauge indicator flashes: ➔ P.312

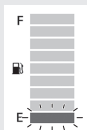

Handle grip heater status icon

CRF1100A4/D4

The handle grip heater status icon will appear while the handle grip heater is on.

➔ P.128

If the handle grip heater status icon flashes: ➔ P.313

Air temperature gauge ➔ P.64

Tachometer

NOTICE

Do not operate the engine in the Tachometer red zone.
Excessive engine speed can adversely affect engine life.

Tachometer red zone

(excessive engine rpm range)

Speedometer

Cruise Control Set Speed

The speed set for cruise control is displayed.

Cruise Control: ➔ P.228

Instruments *(Continued)*

Torque Control level [T] indicator P.129

When the indicator flashes, have your dealer check for problems.

[EB] [Engine Brake] level indicator P.137

When the indicator flashes, have your dealer check for problems.

[P] [Power] level indicator P.137

When the indicator flashes, have your dealer check for problems.

Sub-information indicator P.39

ABS mode [ABS] indicator

 P.137

When the indicator flashes, have your dealer check for problems.

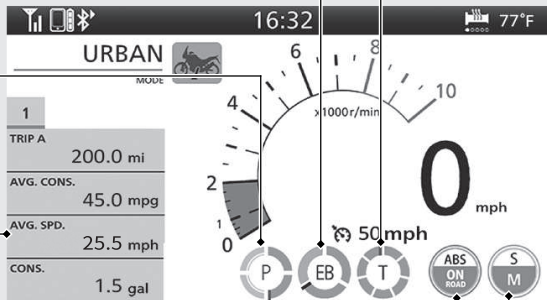

[S] [Overall] indicator P.137

CRF1100A4/D4

When the indicator flashes, have your dealer check for problems.

Bronze image display

Clock (12-hour or 24-hour display)

To set the clock: P.87

Riding mode display

P.137

Side stand indicator

P.64

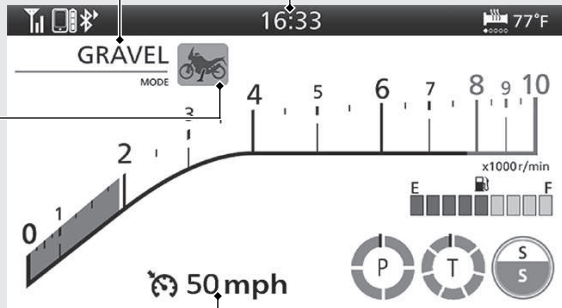

Cruise Control Set Speed

The speed set for cruise control is displayed.

Cruise Control: P.228

Instruments (Continued)

Handle grip heater

status icon

CRF1100A4/D4

The handle grip heater status icon will appear while the handle grip heater is on.

 P.128

If the handle grip heater status icon flashes:

 P.313

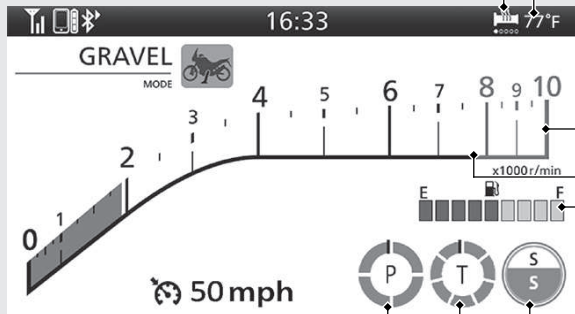

[P] [Power] level indicator  P.137

When the indicator flashes, have your dealer check for problems.

Torque Control level [T] indicator  P.129

When the indicator flashes, have your dealer check for problems.

[S] [Overall] indicator  P.137

CRF1100A4/D4

When the indicator flashes, have your dealer check for problems.

Air temperature gauge ➡ P.64

Tachometer

NOTICE

Do not operate the engine in the Tachometer red zone.
Excessive engine speed can adversely affect engine life.

Tachometer red zone

(excessive engine rpm range)

Fuel gauge

Remaining fuel when only E (1st) segment starts flashing:

Approximately 0.95 US gal (3.6 L) **CRF1100A/D**

Approximately 1.03 US gal (3.9 L) **CRF1100A4/D4**

If the fuel gauge indicator flashes: ➡ P.312



Instruments *(Continued)*

Basic Operations

You can operate and set the various functions of your vehicle using the switches on the left handlebar and  function sel switch on the right handlebar or touch screen.

However, you cannot operate some functions while the vehicle is in motion.

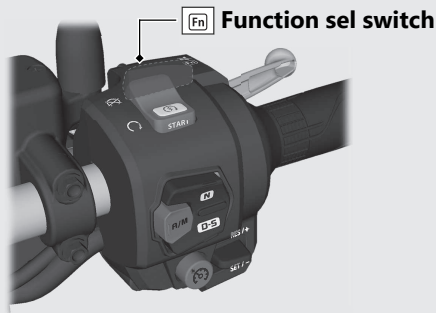

To Return to the Home Screen

Pull backward and hold the  page switch on the left handlebar or touch the clock area of the multi-information display with your vehicle stopped.

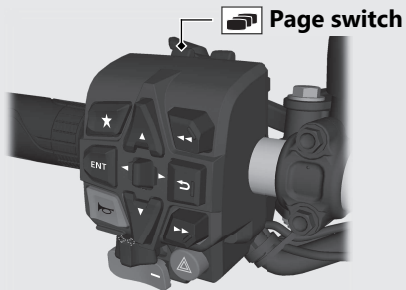

To Select a Desired Setting Menu

To operate with the left handlebar:
Press ▲ or ▼ to select the available choices.

To operate with the left handlebar:
Push ◀ or ▶ to select the available choices.

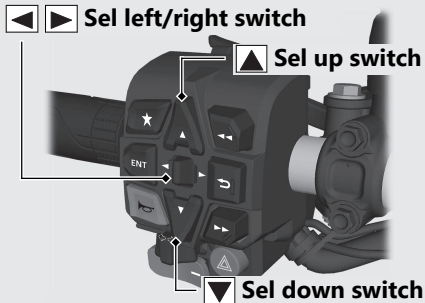

To operate with the touch screen:
Touch the menu to be selected on the touch screen.

To Set Your Selection

To operate with the left handlebar:
Press the **ENT** switch on the left handlebar to set your selection.

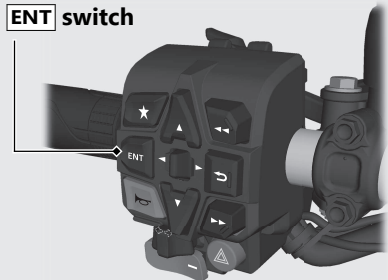

To operate with the touch screen:
Touch the menu to be selected on the touch screen.

Instruments *(Continued)*

To Exit the Setting Menu

To return to the riding information:

Pull backward the  page switch on the left handlebar.

To return to the Home screen:

Pull backward and hold the  page switch on the left handlebar.

To return the previous screen:

Press the  back switch on the left handlebar.

To operate with the touch screen:

Touch the  to be selected on the touch screen.

Also, the setting mode ends when your vehicle speed reaches approximately 4 mph (6 km/h).

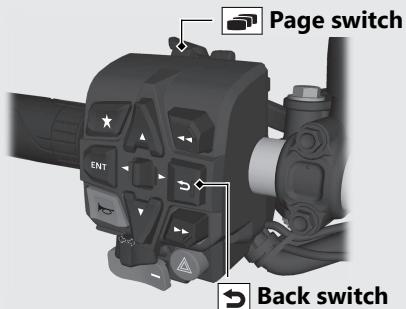

Page 1:

Page 1 shows the following items: Tripmeter A [TRIP A] and three items related to Tripmeter A [TRIP A] and Tripmeter B [TRIP B]. **➡P.83**

- Tripmeter B [TRIP B] display **➡P.48**
- Tripmeter A average fuel mileage [AVG. CONS.] display **➡P.44**
- Tripmeter A average speed [AVG. SPD.] display **➡P.50**
- Tripmeter A current fuel mileage [CONS.] display **➡P.46**
- Tripmeter A elapsed [ELAPSED] display **➡P.47**
- Blank **➡P.58**

1	2	3	4
TRIP A	200.0 mi		
AVG. CONS.	45.0 mpg		
AVG. SPD.	25.5 mph		
CONS.	1.5 gal		

Instruments *(Continued)*

Page 2:

Page 2 shows the following items: Tripmeter B [TRIP B] and three items related to Tripmeter B [TRIP B]. ➔P.83

- Tripmeter B average fuel mileage [AVG. CONS.] display ➔P.49
- Tripmeter B average speed [AVG. SPD.] display ➔P.50
- Tripmeter B current fuel mileage [CONS.] display ➔P.51
- Tripmeter B elapsed [ELAPSED] display ➔P.52
- Blank ➔P.58

1	2	3	4
TRIP B			
		150.0 mi	
AVG. CONS.			
		50.0 mpg	
AVG. SPD.			
		30.0 mph	
CONS.			
		1.2 gal	

Page 3:

Page 3 shows four items selected from the following items. ➔P.83

- Current fuel mileage [INST. CONS.] display ➔P.53
- Available driving distance [RANGE] display ➔P.54
- Battery voltage [VOLTAGE] display ➔P.55
- Date [DATE] display ➔P.55
- Average fuel mileage [AVG. CONS.] display ➔P.56
- Fuel consumption [CONS.] display ➔P.57
- Elapsed time [ELAPSED] display ➔P.57
- Subtraction trip [-TRIP] display ➔P.58
- Blank ➔P.58

1	2	3	4
INST. CONS.		30.0 mpg	
AVG. CONS.		45.0 mpg	
CONS.		1.0 gal	
ELAPSED		02:42	

Instruments *(Continued)*

Page 4:

Page 4 shows the setting values of the following items.

- ABS function on the rear wheel [ABS RR] display **P.59**
- Honda Selectable Torque Control level [HSTC] display **P.60**
- Wheelie Control level [W] display **P.61**
- **CRF1100A4/D4**
Rear suspension preload level [PRELOAD] display **P.62**
- **CRF1100D/D4**
G switch [G] display **P.63**

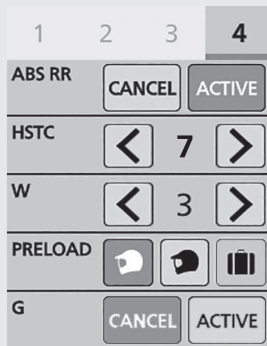

To Switch the Page of Display

- 1 Select the gold image display. P.78
- 2 Push the or of the sel left/right switch until the desired page is displayed.

You can also perform the above settings by using the touch screen.

To Switch the Page 1 or Fuel Gauge

- 1 Select the silver image display. P.78
- 2 Push the or of the sel left/right switch to switch the page or fuel gauge.

Tripmeter A [TRIP A]

Distance ridden since the tripmeter A was reset.

1	2	3	4
TRIP A	200.0 mi		
AVG. CONS.	45.0 mpg		
AVG. SPD.	25.5 mph		
CONS.	1.5 gal		

When "----.-" flashes, have your dealer check for problems.

To reset the tripmeter A [TRIP A]:

P.66

Instruments *(Continued)*

Tripmeter A Average Fuel Mileage [AVG. CONS.]

Displays the average fuel mileage since the tripmeter A was reset.

The average fuel mileage will be calculated based on the value displayed on the selected tripmeter A.

Display range: 0.0 to 299.9 mpg (km/l, l/100 km or mile/L)

- Initial display: "----.-" is displayed.
- More than 299.9 mpg (km/l, or mile/L): "299.9" is displayed.
- More than 299.9 l/100 km: "----.-" is displayed.
- When the tripmeter A is reset: "----.-" is displayed.

1	2	3	4
TRIP A			
		200.0 mi	
AVG. CONS.			
		45.0 mpg	
AVG. SPD.			
		25.5 mph	
CONS.			
		1.5 gal	

When "----.-" flashes, have your dealer check for problems.

To reset the tripmeter A average fuel mileage [AVG. CONS.]:  **P.66**

Tripmeter A Average Speed [AVG. SPD.]

Displays the average speed since the tripmeter A was reset.

The average speed will be calculated based on the value displayed on the selected tripmeter A.

- When the tripmeter A average speed is reset: "299.0" is displayed

Display range: 0.0 to 186.0 mph or 0.0 to 299.0 km/h

1	2	3	4
TRIP A	200.0 mi		
AVG. CONS.	45.0 mpg		
AVG. SPD.	25.5 mph		
CONS.	1.5 gal		

To reset the tripmeter A average speed [AVG. SPD.]:  P.66

Instruments *(Continued)*

Tripmeter A Fuel Consumption [CONS.]

Displays the tripmeter A fuel consumption since the tripmeter A was reset.

Display range: 0.0 to 300.0 gal (L)

- Above 300.0 gal (L): "300.0" is displayed.
- When the tripmeter A fuel consumption is reset: "299.9" is displayed.

1	2	3	4
TRIP A	200.0 mi		
AVG. CONS.	45.0 mpg		
AVG. SPD.	25.5 mph		
CONS.	1.5 gal		

To reset the tripmeter A fuel consumption [CONS.]:  P.66

Tripmeter A Elapsed [ELAPSED]

Displays the tripmeter A elapsed since the tripmeter A was reset.

Display range: 00:00 to 99:59 (hours:minutes)

- The display returns to "00:00" when the read-out exceeds 99:59.

1	2	3	4
TRIP A			
200.0 mi			
AVG. CONS.			
45.0 mpg			
AVG. SPD.			
25.5 mph			
ELAPSED			
01:39			

When "00:00" flashes, have your dealer check for problems.

To reset the tripmeter A elapsed [ELAPSED]:  P.66

Instruments *(Continued)*

■ Tripmeter B [TRIP B]

Distance ridden since the tripmeter B was reset.

1	2	3	4
TRIP B			
150.0 mi			
AVG. CONS.			
50.0 mpg			
AVG. SPD.			
30.0 mph			
CONS.			
1.2 gal			

When "----.-" flashes, have your dealer check for problems.

To reset the tripmeter B [TRIP B]:

➔ P.67

Tripmeter B Average Fuel Mileage [AVG. CONS.]

Displays the average fuel mileage since the tripmeter B was reset.

The average fuel mileage will be calculated based on the value displayed on the selected tripmeter B.

Display range: 0.0 to 299.9 mpg (km/l, l/100 km or mile/L)

- Initial display: "---.-" is displayed.
- More than 299.9 mpg (km/l or mile/L): "299.9" is displayed.
- More than 299.9 l/100 km: "---.-" is displayed.
- When the tripmeter B is reset: "---.-" is displayed.

1	2	3	4
TRIP B			
150.0 mi			
AVG. CONS.			
50.0 mpg			
AVG. SPD.			
30.0 mph			
CONS.			
1.2 gal			

When "---.-" flashes, have your dealer check for problems.

To reset the tripmeter B average fuel mileage [AVG. CONS.]:  **P.67**

Instruments *(Continued)*

Tripmeter B Average Speed [AVG. SPD.]

Displays the average speed since the tripmeter B was reset.

The average speed will be calculated based on the value displayed on the selected tripmeter B.

- When the tripmeter A average speed is reset: "299.0" is displayed.

Display range: 0.0 to 186.0 mph or 0.0 to 299.0 km/h.

1	2	3	4
TRIP B			
		150.0 mi	
AVG. CONS.			
		50.0 mpg	
AVG. SPD.			
		30.0 mph	
CONS.			
		1.2 gal	

To reset the tripmeter B average speed [AVG. SPD.]:  **P.67**

Tripmeter B Fuel Consumption [CONS.]

Displays the tripmeter B fuel consumption since the tripmeter B was reset.

Display range: 0.0 to 300.0 gal (L)

- Above 300.0 gal (L): "300.0" is displayed.
- When the tripmeter B fuel consumption is reset: "299.9" is displayed.

1	2	3	4
TRIP B			
150.0 mi			
AVG. CONS.			
50.0 mpg			
AVG. SPD.			
30.0 mph			
CONS.			
1.2 gal			

To reset the tripmeter B fuel consumption [CONS.]:  P.67

Instruments *(Continued)*

Tripmeter B Elapsed [ELAPSED]

Displays the tripmeter B elapsed since the tripmeter B was reset.

Display range: 00:00 to 99:59 (hours:minutes)

- The display returns to "00:00" when the read-out exceeds 99:59.

1	2	3	4
TRIP B			
150.0 mi			
AVG. CONS.			
50.0 mpg			
AVG. SPD.			
30.0 mph			
ELAPSED			
00:39			

When "00:00" flashes, have your dealer check for problems.

To reset the tripmeter B elapsed [ELAPSED]:  P.67

Current Fuel Mileage [INST. CONS.]

Displays the current instant fuel mileage

Display range: 0.0 to 299.9 mpg (km/l, l/100 km or mile/L)

- When your speed is less than 1 mph (3 km/h): "---.-" is displayed.
- Above 299.9 mpg (km/l or mile/L): "299.9" is displayed.
- Above 299.9 l/100 km: "---.-" is displayed.

1	2	3	4
INST. CONS.		30.0 mpg	
AVG. CONS.		45.0 mpg	
CONS.		1.0 gal	
ELAPSED		02:42	

When "---.-" flashes, have your dealer check for problems.

Instruments *(Continued)*

Available Driving Distance [RANGE]

Displays the estimated distance you can travel on the remaining fuel.

Display range: 999 to 0 mile (999 to 0 km)

- Above 999 mile (km): "999" is displayed.
- Initial display: "0" is displayed.
- When the available driving distance is below 3 mile or 5 km, or the amount of remaining fuel is below 0.2 gal (1.0 L), "---" is displayed.

The indicated available driving distance is calculated based on driving conditions, and the indicated figure may not always be the actual allowable distance.

	1	2	3	4
INST. CONS.			30.0 mpg	
AVG. CONS.			45.0 mpg	
RANGE			20 mile	
-TRIP			50.0 mile	

Battery Voltage [VOLTAGE]

Displays the current battery voltage.

Display range: 7.5 to 18.5 V

1	2	3	4
INST. CONS.			
30.0 mpg			
AVG. CONS.			
45.0 mpg			
VOLTAGE			
 12.0 v			
DATE Wed, 17, May, 2023			

Date [DATE]

Displays today's date.

1	2	3	4
INST. CONS.			
30.0 mpg			
AVG. CONS.			
45.0 mpg			
VOLTAGE			
 12.0 v			
DATE Wed, 17, May, 2023			

To set the current date:  P.87

Instruments *(Continued)*

Average Fuel Mileage [AVG. CONS.]

Displays the average fuel mileage since the average fuel mileage was reset.

Display range: 0.0 to 299.9 mpg (km/l, l/100 km or mile/L)

- Initial display: "----." is displayed.
- More than 299.9 mpg (km/l or mile/L): "299.9" is displayed.
- More than 299.9 l/100 km: "----." is displayed.
- When the average fuel mileage [AVG. CONS.] is reset: "----." is displayed.

1	2	3	4
INST. CONS.		30.0 mpg	
AVG. CONS.		45.0 mpg	
CONS.		1.0 gal	
ELAPSED		02:42	

When "----." flashes, have your dealer check for problems.

To reset the average fuel mileage [AVG. CONS.]:  **P.68**

Fuel Consumption [CONS.]

Displays the fuel consumption.

Display range: 0.0 to 300.0 gal or 0.0 to 300.0

L

- Above 300.0 gal (L): "300.0" is displayed.
- When the engine is starts: "---.-" is displayed.

1	2	3	4
INST. CONS.			
30.0 mpg			
AVG. CONS.			
45.0 mpg			
CONS.			
1.0 gal			
ELAPSED			
02:42			

Elapsed Time [ELAPSED]

Displays operating time since the engine was started.

Display range: 00:00 to 99:59 (hours:minutes)

- The display returns to "00:00" when the read-out exceeds 99:59.

1	2	3	4
INST. CONS.			
30.0 mpg			
AVG. CONS.			
45.0 mpg			
CONS.			
1.0 gal			
ELAPSED			
02:42			

When "00:00" flashes, have your dealer check for problems.

Instruments *(Continued)*

Subtraction Trip [-TRIP]

Distance travelled is subtracted from a preset figure, since the subtraction trip was set up.

Display range: 999.0 to -1,000.0 mile or 1,607.3 to -1,609.0 km

The display locks at "-1000.0" mile ("-1609.0" km) when the read-out exceeds -1000 mile (-1609 km).

1	2	3	4
INST. CONS.		30.0 mpg	
AVG. CONS.		45.0 mpg	
RANGE		20 mile	
-TRIP		50.0 mile	

To set the subtraction trip: P.76

Default: 000

Blank

Display is blank.

1	2	3	4
TRIP A		200.0 mi	
AVG. CONS.		45.0 mpg	
AVG. SPD.		25.5 mph	

ABS Function on the Rear Wheel [ABS RR]

Displays the selected status of the ABS function on the rear wheel [ABS RR].



Available settings: [ACTIVE]/[CANCEL]

Default: [ACTIVE]

To select the ABS function on the rear wheel [ABS RR]: P.118

Instruments *(Continued)*

Honda Selectable Torque Control Level [HSTC]

Display the selected value of the Honda Selectable Torque Control level [HSTC].



Setting range: Level 1 to 7 or 0 (Off)

To select the Honda Selectable Torque Control level [HSTC]: P.129

Wheelie Control Level [W]

Display the selected value of the wheelie control level [W].



Setting range: Level 1 to 3 or 0 (Off)

To select the wheelie control level [W]:

➔ P.133









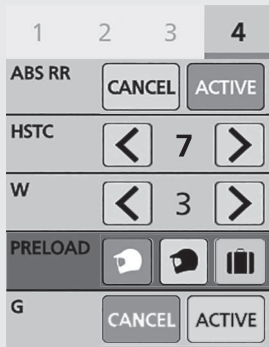



Instruments *(Continued)*

Rear Suspension Preload Mode [PRELOAD]

CRF1100A4/D4

Displays the selected status of the rear suspension preload mode [PRELOAD].



Status icon	Riding condition
  	Rider only (Minimum preload)
  	Rider and luggage
  	Rider and passenger
  	Rider, passenger and luggage (Maximum preload)

Default: Rider only

To select the rear suspension preload mode [PRELOAD]:  **P.298**

G Switch [G]

CRF1100D/D4

Displays the selected status of the G switch [G].



Available settings: [ACTIVE]/[CANCEL]

Default:

- [TOUR MODE]: [CANCEL]
- [URBAN MODE]: [CANCEL]
- [GRAVEL MODE]: [CANCEL]
- [OFF ROAD MODE]: [ACTIVE]
- [USER 1 MODE]: [CANCEL]
- [USER 2 MODE]: [CANCEL]

To select the G switch [G]: P.122

Instruments *(Continued)*

Side Stand Indicator

The side stand indicator flashes when the side stand is put down. It goes off when the side stand is raised.

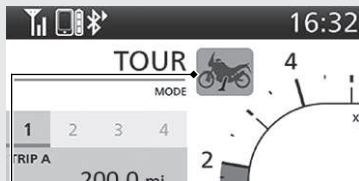

Side stand indicator

Air temperature gauge

Displays the ambient temperature.



Air temperature gauge

Display range: 14 °F (-10 °C) to 122 °F (50 °C)

- Below 13°F (-11°C): "---" is displayed
- Above 122°F (50°C): 122°F (50°C) flashes

Road heat and exhaust from another vehicle can affect the temperature reading when your vehicle speed is less than 19 mph (30 km/h). It may take several minutes for the display to be updated after the temperature reading has stabilized.

Cruise Control Set Speed

The speed set for cruise control is displayed.



Cruise control set speed

To set the cruise control set speed:

➔ P.230

Instruments *(Continued)*

To Reset the Tripmeter A [TRIP A], Tripmeter A Average Fuel Mileage [AVG. CONS.], Tripmeter A Average Speed [AVG. SPD.], Tripmeter A Fuel Consumption [CONS.] and Tripmeter A Elapsed [ELAPSED]

To reset the tripmeter A [TRIP A], tripmeter A average fuel mileage [AVG. CONS.], tripmeter A average speed [AVG. SPD.], tripmeter A fuel consumption [CONS.] and tripmeter A elapsed [ELAPSED], press and hold the **ENT** switch while page 1 is displayed or touch and hold the page 1 area.

1	2	3	4
TRIP A	200.0 mi		
AVG. CONS.	45.0 mpg		
AVG. SPD.	25.5 mph		
CONS.	1.5 gal		

To Reset the Tripmeter B [TRIP B], Tripmeter B Average Fuel Mileage [AVG. CONS.], Tripmeter B Average Speed [AVG. SPD.], Tripmeter B Fuel Consumption [CONS.] and Tripmeter B Elapsed [ELAPSED]

To reset the tripmeter B [TRIP B], tripmeter B average fuel mileage [AVG. CONS.], tripmeter B average speed [AVG. SPD.], tripmeter B fuel consumption [CONS.] and tripmeter B elapsed [ELAPSED], press and hold the **ENT** switch while page 2 is displayed or touch and hold the page 2 area.

1	2	3	4
TRIP B			
150.0 mi			
AVG. CONS.			
50.0 mpg			
AVG. SPD.			
30.0 mph			
CONS.			
1.2 gal			

Instruments *(Continued)*









To Reset the Average Fuel Mileage [AVG. CONS.]

To reset the average fuel mileage [AVG. CONS.], press and hold the **ENT** switch while page 3 is displayed or touch and hold the page 3 area.

1	2	3	4
INST. CONS.			
30.0 mpg			
AVG. CONS.			
45.0 mpg			
CONS.			
1.0 gal			
ELAPSED			
02:42			







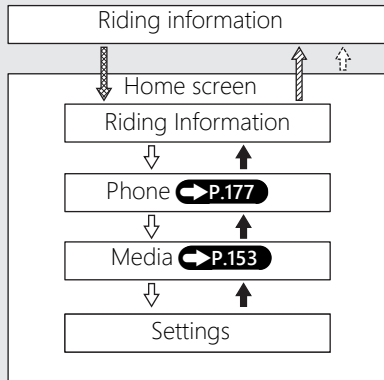

Setting mode

To Shift to the Menu of the Multi-Information Display

-  Pull backward and hold the  page switch or touch the clock area of the multi-information display.
-  Select [Riding Information], and then press the **ENT** switch or touch the [Riding Information] of the multi-information display.
-  Pull backward the  page switch.
-  Press the  sel up switch.
-  Press the  sel down switch.



Instruments *(Continued)*

-  Press the **ENT** switch.
-  Press the  back switch or touch the  of the multi-information display.
-  Press the  sel up switch.
-  Press the  sel down switch.

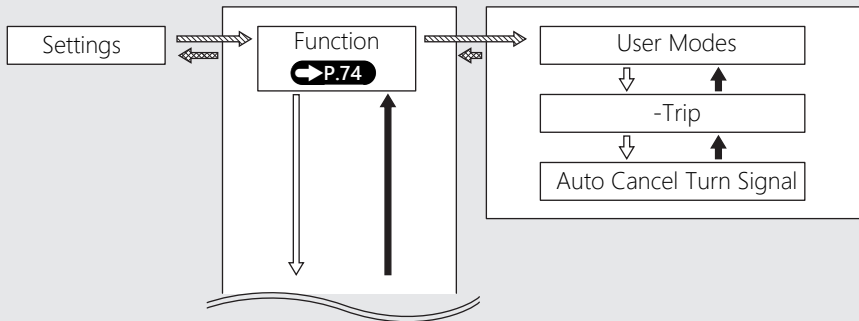

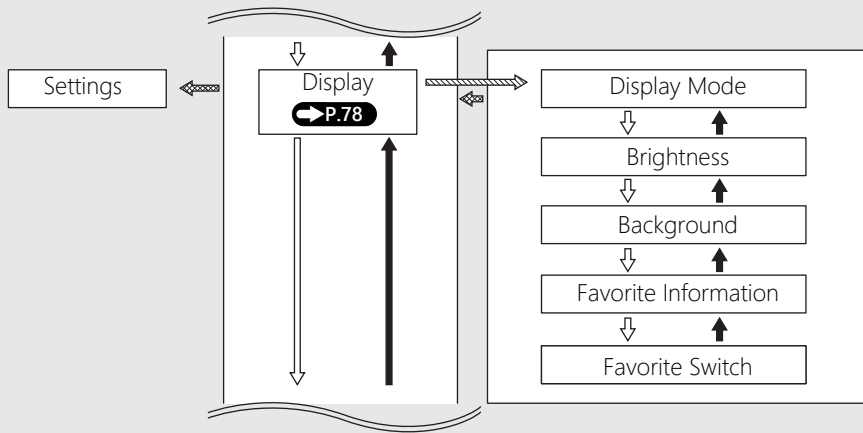

Instruments (Continued)

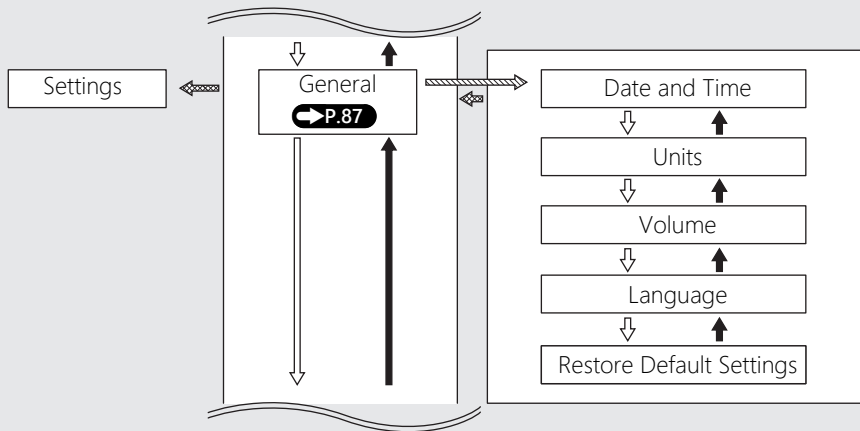

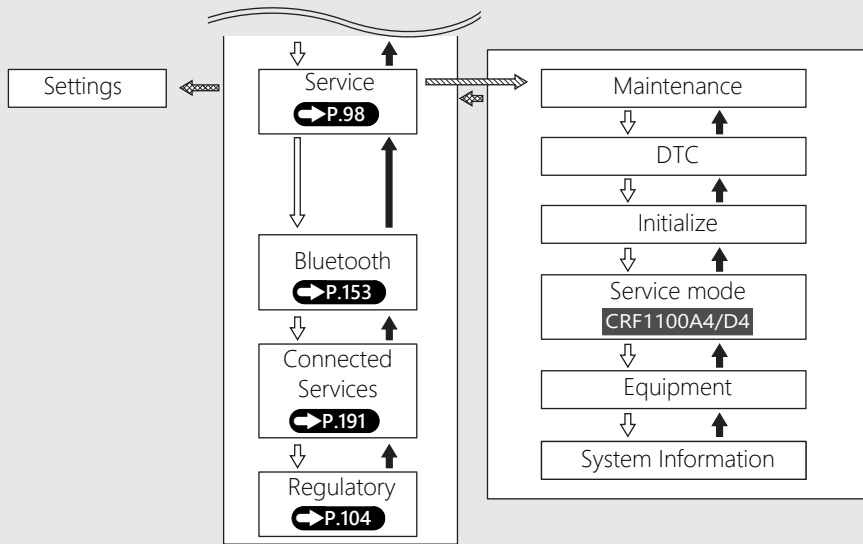

Instruments *(Continued)*

Function

Following items can be changed sequentially.

- User Modes (this page)
- -Trip  **P.76**
- Auto Cancel Turn Signal  **P.77**

User Modes

You can change the [Power], [Engine Brake], [Overall]*1, [Front]*1, [Rear]*1, [ABS], [Preload]*1 values in [USER 1 MODE] and [USER 2 MODE].

*1: **CRF1100A4/D4**

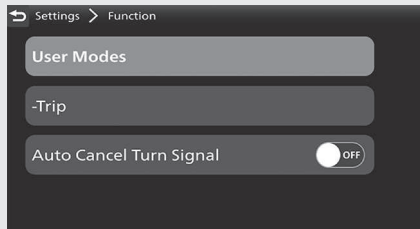

- 1 Select [User Modes], and then press the **ENT** switch.
- 2 Select [User 1] or [User 2] using the ▲ sel up or ▼ sel down switch, and then press the **ENT** switch.

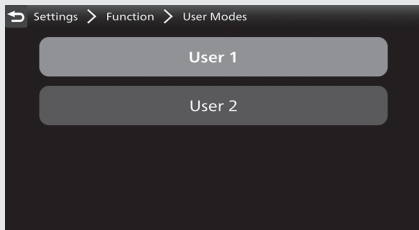

- 3 Press the ▲ sel up switch or ▼ sel down switch to select a setting menu.
- 4 Push the ◀ or ▶ of the ◀ ▶ sel left/right switch until the desired value is displayed.
 - ▶ Push and hold the ◀ or ▶ of the ◀ ▶ sel left/right switch to advance the figure fast.

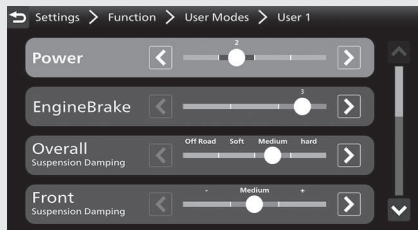

- 5 Return to the riding information, previous screen or Home screen. ➡ P.38
- You can also perform the above settings by using the touch screen.

Available settings: ➡ P.141

Default: ➡ P.139

Instruments *(Continued)*

-Trip

You can also adjust value of the subtraction trip [-TRIP].

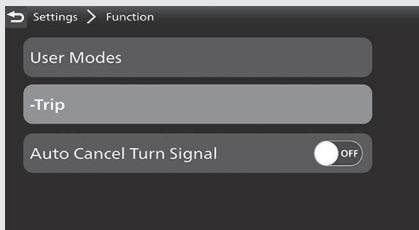

- 1 Select [-Trip], and then press the **ENT** switch.
- 2 Select the digits using the **◀** or **▶** of the **◀ ▶** sel left/right switch.
- 3 To increase value: Press the **▲** sel up switch, until the desired value is displayed.
To decrease value: Press the **▼** sel down switch, until the desired value is displayed.

- ▶ Press and hold the **▲** sel up switch or sel **▼** down switch to advance the figure fast.

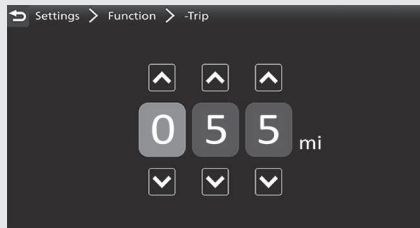

- 4 Return to the riding information, previous screen or Home screen. **➡P.38**

You can also perform the above settings by using the touch screen.

Setting range: 000 to 999

Default: 000

Auto Cancel Turn Signal

You can enable/disable turn signal automatic cancellation.

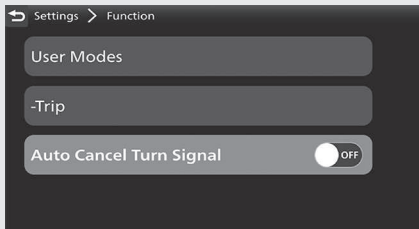

- 1 Select [Auto Cancel Turn Signal], and then press the **ENT** switch to [ON] (enable) or [OFF] (disable) the function.
- 2 Return to the riding information, previous screen or Home screen. **➡ P.38**

You can also perform the above settings by using the touch screen.

Available settings: [ON]/[OFF]

Default: [ON]

Instruments *(Continued)*

Display

Following items can be changed sequentially.

- Display Mode (this page)
- Brightness → P.80
- Background → P.81
- Favorite Information → P.83
- Favorite Switch → P.85

Display Mode

You can select the riding information image.

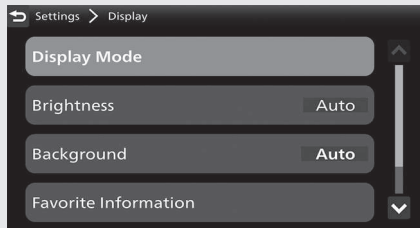

- 1 Select [Display Mode], and then press the **ENT** switch.
- 2 Press the ▲ sel up switch or ▼ sel down switch to select a setting menu.
- 3 Push the ◀ or ▶ of the ◀ ▶ sel left/right switch to select your desired display.

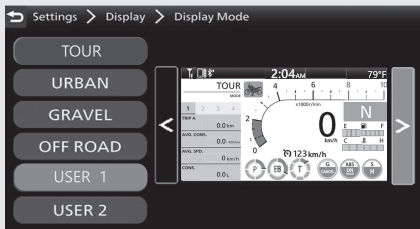

- 4 Return to the riding information, previous screen or Home screen. ➡ **P.38**

You can also perform the above settings by using the touch screen.

Available settings: Gold image/Silver image/Bronze image

Default:

- [TOUR MODE]: Gold image
- [URBAN MODE]: Silver image
- [GRAVEL MODE]: Silver image
- [OFF ROAD MODE]: Bronze image
- [USER 1 MODE]: Silver image
- [USER 2 MODE]: Bronze image

Instruments *(Continued)*

Brightness

You can select the backlight brightness.

The display can become dark when the display is very hot. If it does not restore the original brightness, contact your dealer.

Automatic Brightness Control:  **P.341**

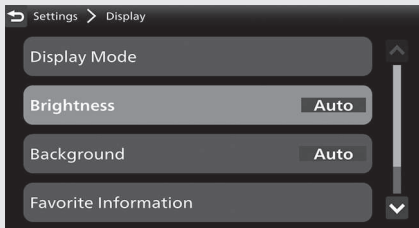

- 1 Select [Brightness], and then press the **ENT** switch.
- 2 Select [Auto], and then press the **ENT** switch to [ON] (auto) or [OFF] (manual) the function.

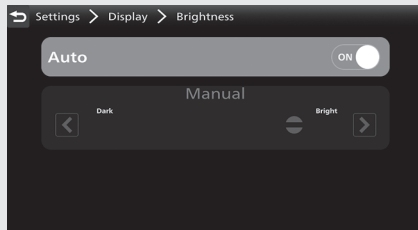

- 3 If you select to [OFF] (manual) push the ◀ or ▶ of the ◀▶ sel left/right switch to select your preferred level.
▶ Push and hold the ◀ or ▶ of the ◀▶ sel left/right switch to advance the figure fast.

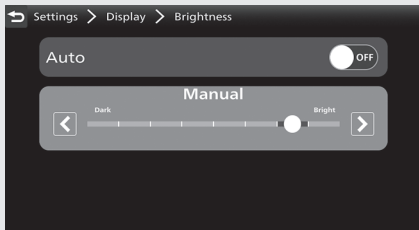

- 4 Return to the riding information, previous screen or Home screen. ➡P.38

You can also perform the above settings by using the touch screen.

Setting range: Level 1 to 8 or [Auto]

Default: [Auto]

Background

You can select the background.

Automatic Background Control:

➡P.341

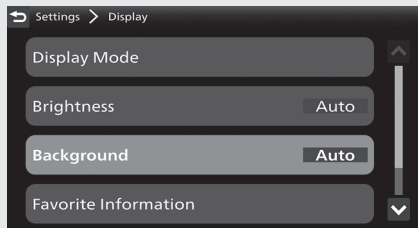

Instruments *(Continued)*

- 1 Select [Background], and then press the **ENT** switch.
- 2 Select [Auto], and then press the **ENT** switch to [ON] (auto) or [OFF] (manual) the function.
- 3 If you select to [ON] (auto), push the ◀ or ▶ of the ◀ ▶ sel left/right switch to select your preferred level.
 - ▶ Push and hold the ◀ or ▶ of the ◀ ▶ sel left/right switch to advance the figure fast.

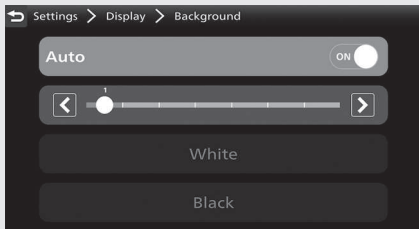

If you select to [OFF] (manual), press the ▲ sel up switch or ▼ sel down switch to select the [White] or [Black].

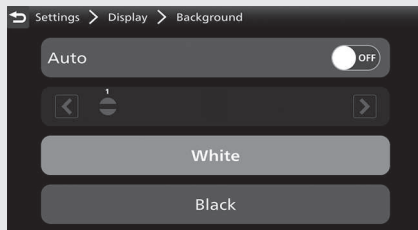

- 4 Return to the riding information, previous screen or Home screen. ➡ **P.38**

You can also perform the above settings by using the touch screen.

Setting range: Auto Level 1 to 7, White or Black

Default: Auto 1

Favorite Information

You can select the following:

● Page 1

- Tripmeter A average fuel mileage [AVG. CONS.]
- Tripmeter A average speed [AVG. SPD.]
- Tripmeter A current fuel mileage [CONS.]
- Tripmeter A elapsed [ELAPSED]
- Tripmeter B [TRIP B]
- Blank

● Page 2

- Tripmeter B average fuel mileage [AVG. CONS.]
- Tripmeter B average speed [AVG. SPD.]
- Tripmeter B current fuel mileage [CONS.]
- Tripmeter B elapsed [ELAPSED]
- Blank

● Page 3

- Current fuel mileage [INST. CONS.]
- Available driving distance [RANGE]
- Battery voltage [VOLTAGE]
- Date [DATE]
- Average fuel mileage [AVG. CONS.]
- Fuel consumption [CONS.]
- Elapsed time [ELAPSED]
- Subtraction trip [-TRIP]
- Blank

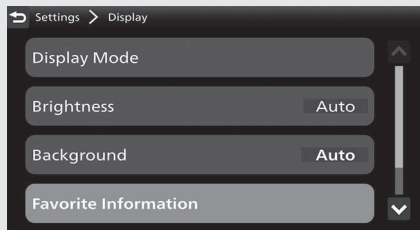

Instruments *(Continued)*

- 1 Select [Favorite Information], and then press the **ENT** switch.
- 2 Push the ◀ or ▶ of the ◀ ▶ sel left/right switch until the desired page is displayed.
- 3 Press ▲ / ▼ to select the available choices, and then press the **ENT** switch.

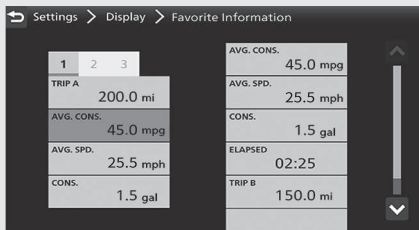

- 4 Press ▲ / ▼ to select the available choices, and then press the **ENT** switch.

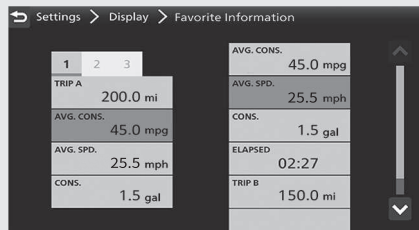

- 5 Return to the riding information, previous screen or Home screen. **→ P.38**
You can also perform the above settings by using the touch screen.

Default:

- Page 1
 - Tripmeter A average fuel mileage [AVG. CONS.]
 - Tripmeter A average speed [AVG. SPD.]
 - Tripmeter A current fuel mileage [CONS.]
- Page 2
 - Tripmeter B average fuel mileage [AVG. CONS.]
 - Tripmeter B average speed [AVG. SPD.]
 - Tripmeter B current fuel mileage [CONS.]
- Page 3
 - Current fuel mileage [INST. CONS.]
 - Available driving distance [RANGE]
 - Battery voltage [VOLTAGE]
 - Date [DATE]

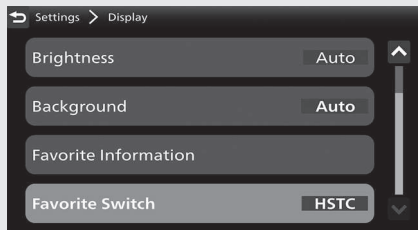
Favorite Switch

Instruments *(Continued)*

- 1 Select [Favorite Switch], and then press the **ENT** switch.
- 2 Press the **▲** sel up switch or **▼** sel down switch to select your desired mode.

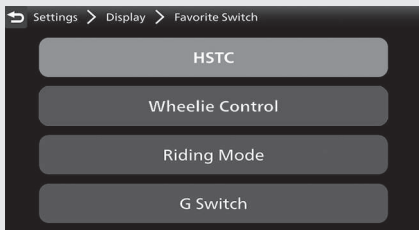

- 3 Return to the riding information, previous screen or Home screen. **➡ P.38**





You can also perform the above settings by using the touch screen.

Available settings: [HSTC]/
[Wheelie Control]/[Riding Mode]/
[G Switch] **CRF1100D/D4**

Default: [HSTC]

General

Following items can be changed sequentially.

- Date and Time (this page)
- Units  P.90
- Volume  P.92
- Language  P.94
- Restore Default Setting  P.95

Date and Time

The multi-information display receives signals from GPS satellites and updates the date and time automatically.

You can also adjust the date and time manually.

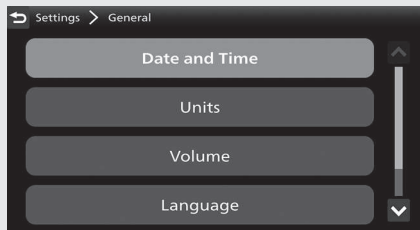

Instruments *(Continued)*

To [ON] (auto) adjust time automatically function:

- 1 Select [Date and Time], and then press the **ENT** switch.
- 2 Select [Adjust Time Automatically], and then press the **ENT** switch to [ON] (auto) the function.

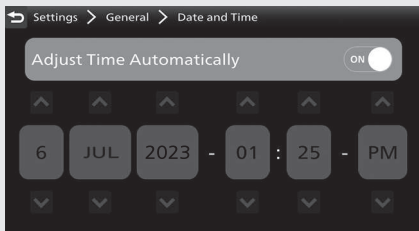

When GPS cannot be located. Read the notice message, and then press the **ENT** switch.

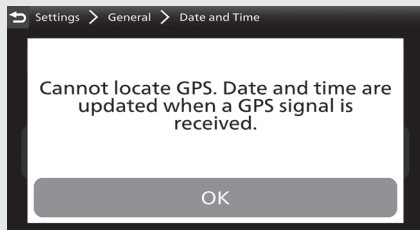

- 3 Return to the riding information, previous screen or Home screen. ➡ **P.38**

You can also perform the above settings by using the touch screen.

To adjust the clock manually:

- 1 Select [Date and Time], and then press the **ENT** switch.
- 2 Select [Adjust Time Automatically], and then press the **ENT** switch to [OFF] (manual) the function.

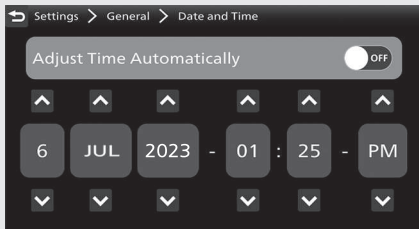

- 3 Press **◀** / **▶** on the sel **◀** **▶** left/right switch to select a day, month, year, hour, minute or time format.
 - To advance the day, month, year, hour or minute: Press the **▲** sel up switch until the desired value is displayed. To delay the day, month, year, hour or minute: Press the **▼** sel down switch until the desired value is displayed.
 - ▶ Press and hold the **▲** sel up switch or **▼** sel down switch to advance the figure fast.
 - To select the time format: Press the **▲** sel up switch or **▼** sel down switch until the desired time format is displayed.

Instruments *(Continued)*

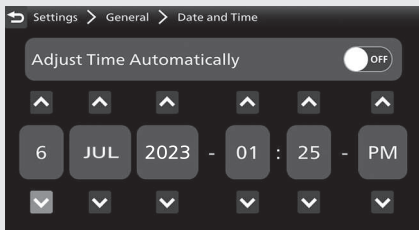

- 4 Return to the riding information, previous screen or Home screen. ➡ **P.38**

You can also perform the above settings by using the touch screen.

Available settings: [ON] (auto)/[OFF] (manual)

Default: [ON] (auto)

Units

You can change the following units.

- [Speed]: [mph] or [km/h]
- [Temperature]: [°F] or [°C]
- [Fuel Consumption]: [mpg] or [mile/L]
If the [km/h] for speed is selected, the fuel mileage shown by [l/100 km] or [km/l].

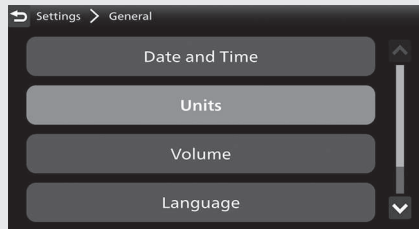

- 1 Select [Units], and then press the **ENT** switch.
- 2 Press the **▲** sel up switch or **▼** sel down switch to select a setting menu.
- 3 Push the **◀** or **▶** of the **◀▶** sel left/right switch to select your desired unit.

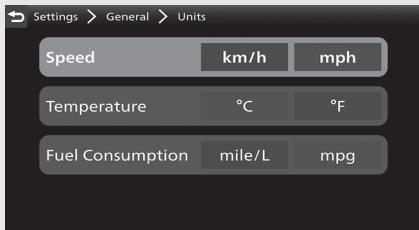

- 4 Return to the riding information, previous screen or Home screen. **→P.38**

You can also perform the above settings by using the touch screen.

Available settings:

- [Speed]: [mph]/[km/h]
- [Temperature]: [°F]/[°C]
- [Fuel Consumption]: [mpg]/[mile/L]/[l/100 km]/[km/l]

Default:

USA model

- [Speed]: [mph]
- [Temperature]: [°F]
- [Fuel Consumption]: [mpg]

Canadian model

- [Speed]: [km/h]
- [Temperature]: [°C]
- [Fuel Consumption]: [l/100 km]

Instruments *(Continued)*

Volume

Selects the volume setting to automatically increase volume from the headsets as the speed of the vehicle increases.

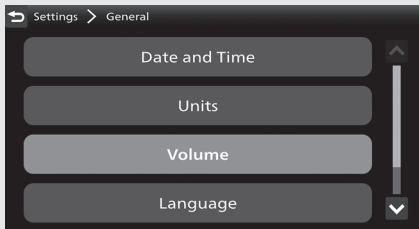

To [Off] (disable), [Low] or [High] automatic volume function:

- 1 Select [Volume], and then press the **ENT** switch.
- 2 Select [Auto Volume], and then press the **ENT** switch.

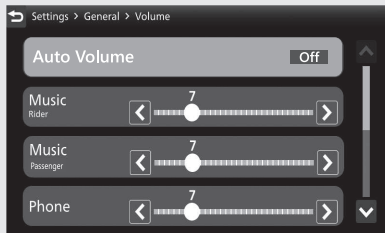

- 3 Press the **▲** sel up switch or **▼** sel down switch to set your selection.

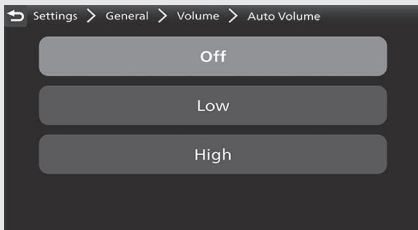

- 4 Return to the riding information, previous screen or Home screen. ➔ P.38

You can also perform the above settings by using the touch screen.

Available settings: [Off] (disable)/[Low]/[High]

Default: [Off] (disable)

To adjust the volume:

- 1 Select [Volume], and then press the **ENT** switch.
- 2 Press the ▲ sel up switch or ▼ sel down switch to select a setting menu.
- 3 Push the ◀ or ▶ of the ◀ ▶ sel left/right switch to select your preferred level.
 - ▶ Push and hold the ◀ or ▶ of the ◀ ▶ sel left/right switch to advance the figure fast.

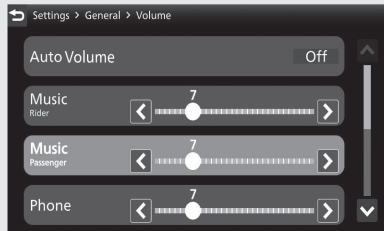

Instruments *(Continued)*

- ④ Return to the riding information, previous screen or Home screen.  **P.38**

You can also perform the above settings by using the touch screen.

VOLUME level range:

Other than Microphone: Level 0 to 30

Microphone: Level 0 to 14



Default:

- Music (Rider): 7
- Music (Passenger): 7
- Phone: 7
- System: 7
- Ringtone: 7
- Voice: 7
- Microphone: 7

Language

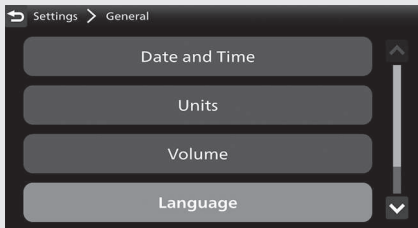
Changes the system language.



- ① Select [Language], and then press the **ENT** switch.
- ② Press the  sel up switch or  sel down switch to select the display language that you want to use on the screen.

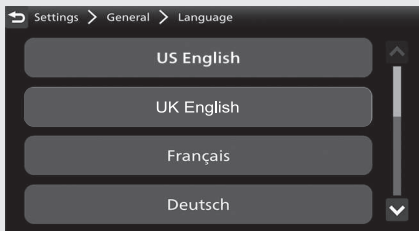

- 3 Return to the riding information, previous screen or Home screen. ➔ P.38

You can also perform the above settings by using the touch screen.

Default: [US English]

Restore Default Settings

The set values can be returned to default settings.

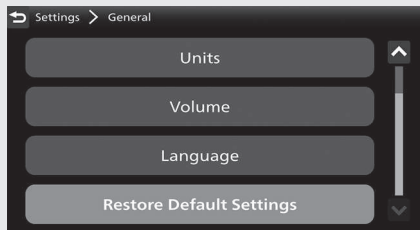

- 1 Select [Restore Default Settings], and then press the **ENT** switch.

Instruments *(Continued)*

2 Select [No] (not restore) or [Yes] (restore) using the ▲ sel up or ▼ sel down switch.

3 When [No] is selected

Press the **ENT** switch.

The set value is maintained, and then the display returns to the [General] menu screen.

When [Yes] is selected

Press the **ENT** switch.

The display changes to the confirmation screen.

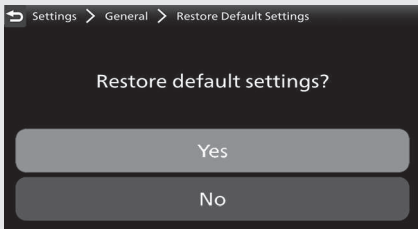

4 Select [No] (not restore) or [Yes] (restore) using the ▲ sel up or ▼ sel down switch on the confirmation screen.

5 When [No] is selected

Press the **ENT** switch.

The set value is maintained, and then the display returns to the [General] menu screen.

When [Yes] is selected

Press the **ENT** switch.

The set value return to default setting, and then the display returns to the [General] menu screen.

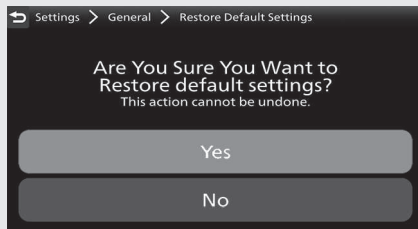

- 6 Return to the riding information, previous screen or Home screen. **→P.38**

You can also perform the above settings by using the touch screen.

Default setting values:

- -TRIP: 000
- Display mode:
 - ▶ [TOUR MODE]: Gold image
 - ▶ [URBAN MODE]: Silver image
 - ▶ [GRAVEL MODE]: Silver image
 - ▶ [OFF ROAD MODE]: Bronze image
 - ▶ [USER 1 MODE]: Silver image
 - ▶ [USER 2 MODE]: Bronze image
- Brightness: Auto
- Background: Auto 1
- Favorite information:
 - ▶ Page 1:
 - Tripmeter A average fuel mileage [AVG. CONS.]
 - Tripmeter A average speed [AVG. SPD.]
 - Tripmeter A current fuel mileage [CONS.]
 - ▶ Page 2:
 - Tripmeter B average fuel mileage [AVG. CONS.]
 - Tripmeter B average speed [AVG. SPD.]
 - Tripmeter B current fuel mileage [CONS.]
 - ▶ Page 3:
 - Current fuel mileage [INST. CONS.]
 - Available driving distance [RANGE]
 - Battery voltage [VOLTAGE]
 - Date [DATE]

Instruments *(Continued)*

- Favorite switch: [HSTC]
- Auto Volume: [OFF]
- Periodic Maintenance:
 - Distance: "-----"
 - Date: "----/----"
- Oil Change:
 - Distance: "-----"
 - Date: "----/----"
- Delete the *Bluetooth*® paired device

Service

Following items can be changed sequentially.

- Maintenance ➡ P.99
- DTC ➡ P.101
- Initialize ➡ P.102
- Service mode CRF1100A4/D4 ➡ P.103
- Equipment ➡ P.104
- System Information ➡ P.104

Maintenance

You can check the next periodic inspection time and next engine oil change.

You can change the setting of the next periodic inspection and next engine oil change.

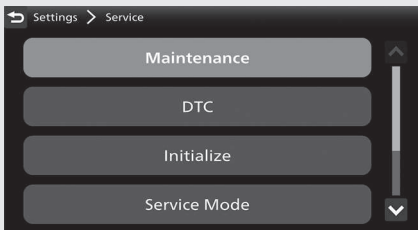

- 1 Select [Maintenance], and then press the **ENT** switch.
- 2 Press the ▲ sel up switch or ▼ sel down switch to select a setting menu, and then press the **ENT** switch.

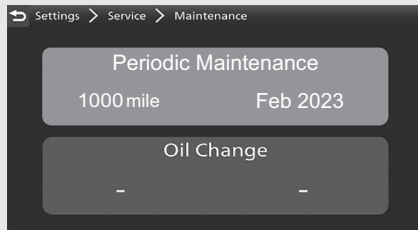

- 3 Press ◀ or ▶ of the ◀ ▶ sel left/right switch to select a distance, month or year section.

Instruments *(Continued)*

- To advance the distance, month or year: Press the ▲ sel up switch until the desired value is displayed.
To delay the distance, month or year: Press the ▼ sel down switch until the desired value is displayed.
- ▶ Press and hold the ▲ sel up switch or ▼ sel down switch to advance the figure fast.

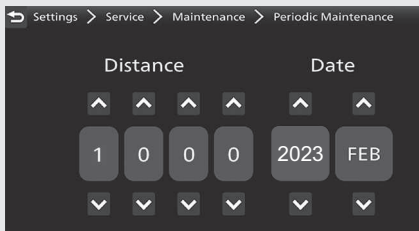

- 4 Return to the riding information, previous screen or Home screen. ➡ P.38

You can also perform the above settings by using the touch screen.

Setting range:

- Periodic Maintenance:
 - Distance: 100 to 4,000 mile or 100 to 6,400 km
 - Date: 2000/JAN to 2099/DEC
- Oil Change:
 - Distance: 100 to 8,000 mile or 100 to 12,800 km
 - Date: 2000/JAN to 2099/DEC

Default:

- Periodic Maintenance:
 - Distance: "-----"
 - Date: "----/----"
- Oil Change:
 - Distance: "-----"
 - Date: "----/----"

DTC

You can check for a current problem with the PGM-FI system.

If your vehicle has problem, DTC index is displayed.

Reduce speed and have your vehicle inspected by your dealer as soon as possible.

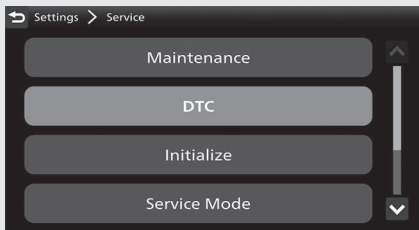

- 1 Select [DTC], and then press the **ENT** switch.

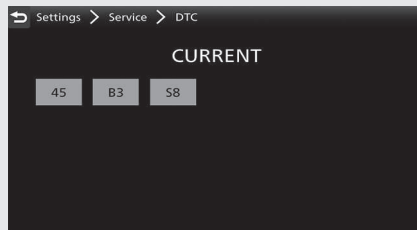

- 2 Return to the riding information, previous screen or Home screen. **➡ P.38**
You can also perform the above settings by using the touch screen.

Instruments *(Continued)*

Initialize

You can calibrate the sensitivity of the touch screen.

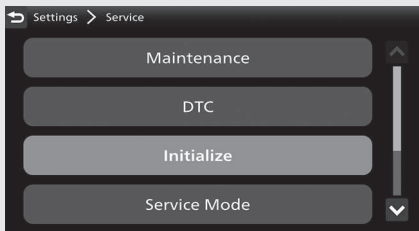

- 1 Select [Initialize], and then press the **ENT** switch.
- 2 Select [Touchscreen Calibration], and then press the **ENT** switch.

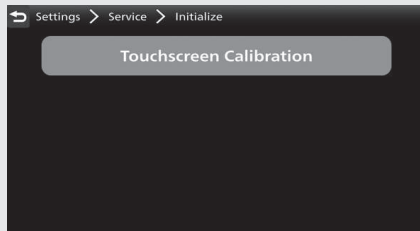

- 3 Touch the center on each of the four crosses.
- ▶ The screen flashes green when calibration is complete. If calibration fails, the screen flashes red. Try step 3 again.

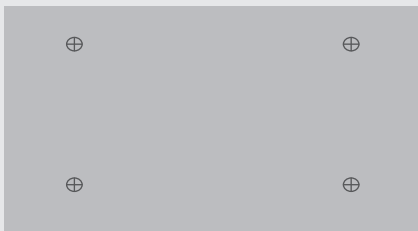

- 4 Return to the riding information, previous screen or Home screen. ➔ P.38
- You can also perform the above settings by using the touch screen.

Service Mode

CRF1100A4/D4

The cornering light can be turned on when the vehicle is stopped for inspection.

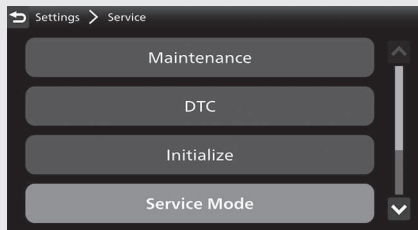

- 1 Start the engine. ➔ P.216
- 2 Stop the vehicle.
- 3 Select [Service Mode], and then press the **ENT** switch.

Instruments *(Continued)*

- 4 Select [Cornering Light Service Mode], and then press the **ENT** switch.
The cornering light lights up.
 - ▶ The service mode will automatically stop in 5 minutes.

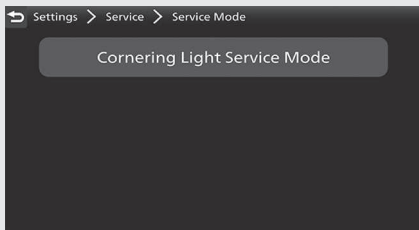

- 5 Return to the riding information, previous screen or Home screen. **➡ P.38**
You can also perform the above settings by using the touch screen.

Equipment

This menu cannot be selected.

System Information

Shows various information of the multi-information display.

- [Software Version]
- [Software update]: Cannot be selected.
- [Hardware Information]
- [GPS Reception Status]
- [EULAs]
- [Copyright and Acknowledgements]

Regulatory

Shows regulatory information of the multi-information display.



Pop-up information

In the following cases, pop-up information is displayed at the bottom of the multi-information display.

- Maintenance information:

When the inspection time of your vehicle is approaching.

Maintenance information

Indication	Explanation	Remedy
	When the periodic inspection time of your vehicle is approaching	Have your vehicle inspected by your dealer.
	When the oil change time of your vehicle is approaching	Change the engine oil.

Indicators

If one of these indicators does not come on when it should, have your dealer check for problems.

High coolant temperature indicator

Comes on briefly when the ignition switch is turned to the ON position.

If it comes on while riding:  **P.307**

Left turn signal indicator

PGM-FI (Programmed Fuel Injection) malfunction indicator lamp (MIL)

Comes on briefly when the ignition switch is turned to the ON position.

If it comes on while engine is running:  **P.308**

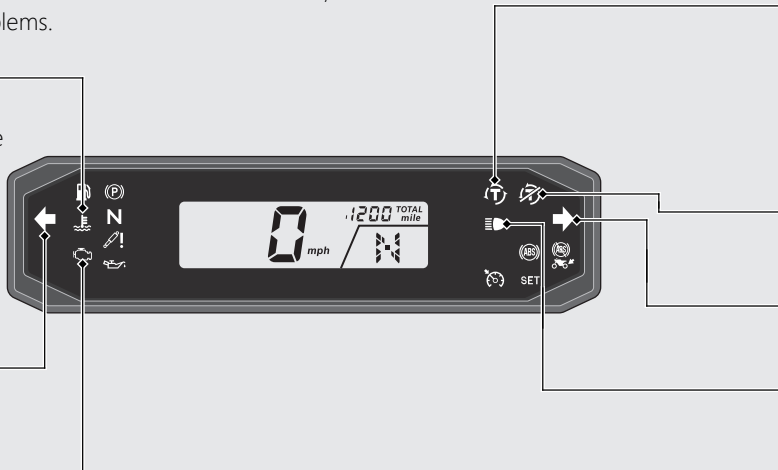

 **Torque Control indicator**

- Comes on when the ignition switch is turned to the ON position. Goes off when your speed reaches approximately 3 mph (5 km/h) to indicate Torque Control is ready to work.
- Blinks when Torque Control is operating.

If it comes on while riding:  **P.310**

 **Torque Control OFF Indicator**

- Comes on when the Torque Control is turned Off.

 **Right turn signal indicator**

 **High beam indicator**

Indicators *(Continued)*

(P) Parking brake indicator

CRF1100D/D4

Lights as a reminder that you have not released the parking brake lever.

(N) Neutral indicator

Comes on when the transmission is in Neutral.



(Fuel) Low fuel indicator

- Comes on briefly when the ignition switch is turned to the ON position.
- Comes on when there is only reserve fuel left in the fuel tank.

Remaining fuel when low fuel indicator comes on:

Approximately 0.95 US gal (3.6 L) **CRF1100A/D**

Approximately 1.03 US gal (3.9 L) **CRF1100A4/D4**

If the indicator comes on and the fuel gauge indicator flashes: ➡ P.312

 **ABS (Anti-lock Brake System) indicator**

- Comes on when the ignition switch is turned to the ON position.
- Goes off when your speed reaches approximately 6 mph (10 km/h).

If it comes on while riding:  **P.309**

 **Rear ABS (Anti-lock Brake System) OFF Indicator**

- Comes on briefly when the ignition switch is turned to the ON position.
- Comes on when the ABS function on the rear wheel is turned off.  **P.118**

 **Cruise control SET indicator**

Comes on if you have set a speed for cruise control.

Cruise Control:  **P.228**

 **Cruise control main indicator**

Comes on when you press  cruise control main switch.

Cruise Control:  **P.228**

Indicators *(Continued)*

Suspension indicator CRF1100A4/D4

- Comes on when the suspension initialization is waiting.
- Stop your vehicle and wait for a few seconds until the indicator turns off. If indicator dose not turn off, contact your dealer.



Low oil pressure indicator

- Comes on when the ignition switch is turned to the ON position.
- Goes off when the engine starts.

If it comes on while engine is running:  **P.308**

This page intentionally left blank.

Switches

Left handlebar switch ➔ P.114

Right handlebar switch ➔ P.113

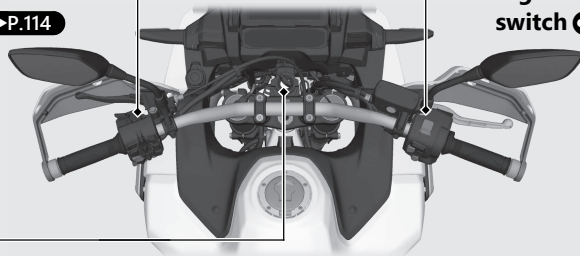

Ignition switch

Switches the electrical system on/off, locks the steering.

- ▶ Key can be removed when in the OFF or LOCK position.

Steering Lock: ➔ P.117

ON
Turns electrical system on for starting/riding.

OFF
Turns engine off.

LOCK
Locks steering.



Right handlebar switch

Engine stop switch/

START button

Should normally remain in the  (Run) position.

- ▶ In an emergency, switch to the  (Stop) position to stop the engine.
- ▶ To start the engine.

 **P.216**

AT/MT switch

CRF1100D/D4

To shift between the AT MODE and MT MODE.

 **P.225**

Cruise control main switch

Press to activate the cruise control system.  **P.228**

Function sel switch

Press to display the pop-up information on the multi-information display.

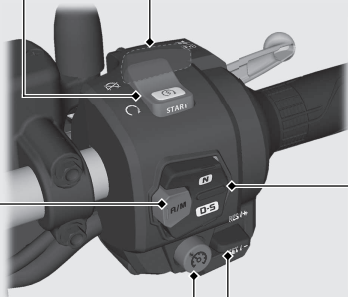

N-D switch

CRF1100D/D4

To shift between Neutral and AT MODE.  **P.225**

Cruise control lever

Push up or down to set the speed or adjust the set speed.  **P.230**

Switches *(Continued)*

Left handlebar switch

★ Favorite switch

Favorite switch can be assigned to the HSTC switch, wheelie control switch, riding mode switch or G switch (CRF1100D/D4). ➔ P.85



Horn button



Turn signal switch

The turn signal will automatically stop when you complete the turn. (You can manually cancel the lights by pressing the switch in.) When used for a lane change, the turn signal will automatically stop in 7 seconds or after riding 131 yards (120 m). In some cases, the timing at which the turn signal stops could be less or more. Always use the recommended tires to ensure correct automatic cancellation operation.

Shift down switch (-)

CRF1100D/D4

To shift down the gear. ➔ P.227



Hazard switch

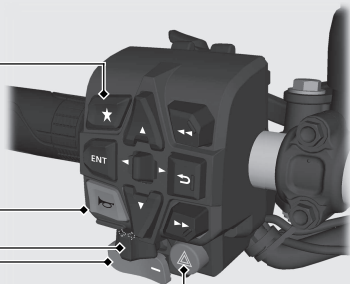

Switchable when the ignition switch is turned to the ON position. Can be turned to off regardless of the ignition switch position.

- ▶ The signals continue flashing with the ignition switch in OFF or LOCK after the hazard switch is on.

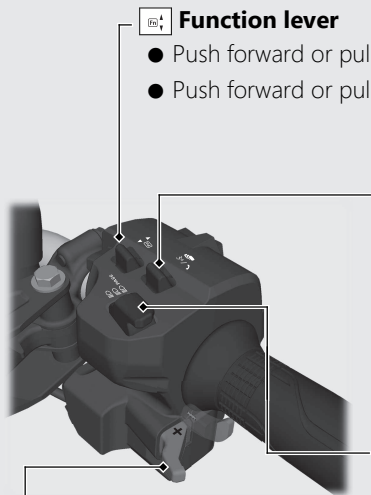











Function lever

- Push forward or pull backward to adjust the audio system volume.  **P.151**
- Push forward or pull backward to adjust the grip heater level.  **P.127**

Voice control switch / **Page switch**

- Push forward to receive, reject or end a call.  **P.185**
- Push forward to start Siri or voice search when Apple CarPlay or **Android Auto™** is available.  **P.200**  **P.214**
- Pull backward and hold to go to the Home screen, Apple CarPlay screen or **Android Auto™** screen.  **P.36**
- Pull backward to return to the riding information or audio screen.  **P.38**

Headlight dimmer/Passing light control switch

-  : High beam
-  : Low beam
-  **PASS** : Flashes the high beam headlight.

Shift up switch (+)

CRF1100D/D4

To shift up the gear.  **P.227**

Switches *(Continued)*

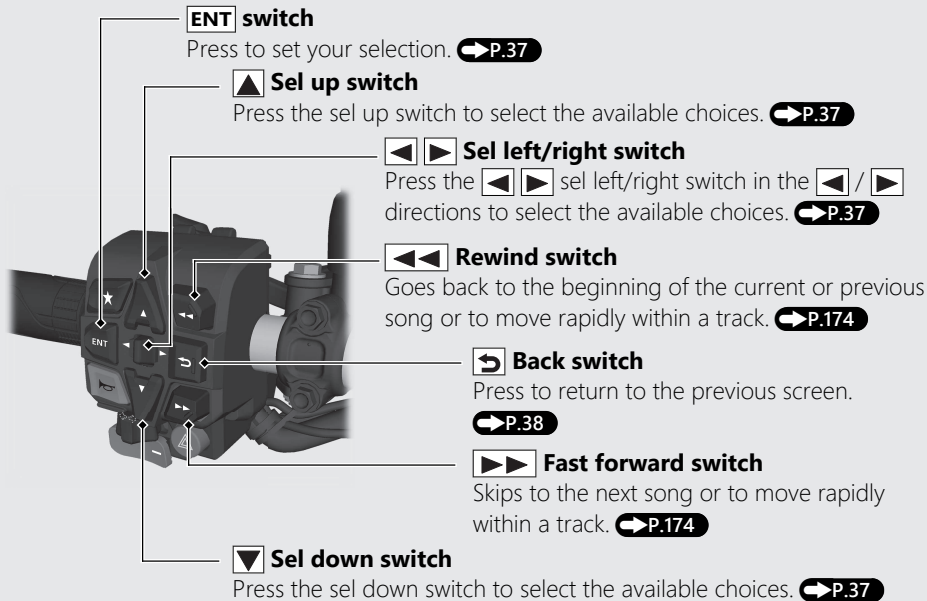

Steering Lock

Lock the steering when parking to help prevent theft.

A U-shaped wheel lock or similar device is also recommended.

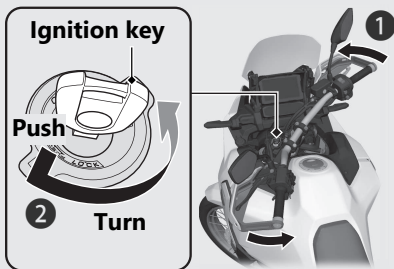

Locking

- 1 Turn the handlebar all the way to the left.
- 2 Push the key down, and turn the ignition switch to the LOCK position.
 - ▶ Jiggle the handlebar if the lock is difficult to engage.
- 3 Remove the key.

Unlocking

Insert the key, push it in, and turn the ignition switch to the OFF position.

ABS function on the rear wheel

The ABS function on the rear wheel can be optionally turned off for off-road riding. You can turn off the rear wheel ABS function in [OFF ROAD MODE], [USER 1 MODE] or [USER 2 MODE].

- ▶ Each time the ignition switch is turned to the ON position, the ABS function on both wheels will automatically be turned on [ACTIVE].
- ▶ Select [ON ROAD] of ABS mode [ABS], the ABS function on both wheels [ABS RR] will automatically be turned on [ACTIVE].
- ▶ When changing the riding mode, the ABS function on both wheels will automatically be turned on [ACTIVE].



To turn off the ABS function on the rear wheel

- 1 Stop the vehicle and close the throttle completely.
- 2 Select [OFF ROAD MODE], [USER 1 MODE] or [USER 2 MODE] mode of riding mode.

➡ P.143

If [USER 1 MODE] or [USER 2 MODE] is selected, select [OFF ROAD] for ABS mode [ABS]. ➡ P.74

- 3 Select the gold image display. ➡ P.78
- 4 Select page 4. ➡ P.43

- 5 Press the **ENT** switch.
- 6 Select [ABS RR].
- 7 Press  on the  sel left/right switch to select [CANCEL] (off).

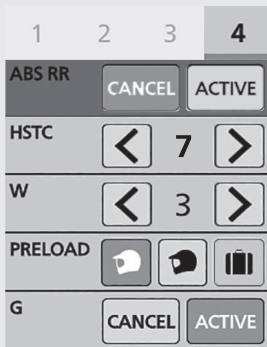

- 8 Read the notice message.
- 9 Select [Yes], and then press the **ENT** switch.

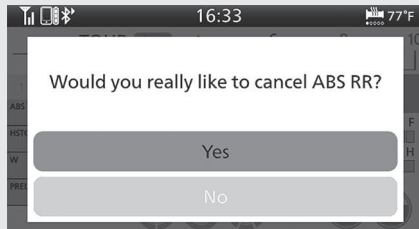

- 10 Press the  back switch.
 - ▶ The rear ABS OFF indicator is on, when the ABS function on the rear wheel [ABS RR] is turned [CANCEL] (off).

You can also perform the above settings by using the touch screen.

ABS function on the rear wheel *(Continued)*

To turn on the ABS function on both wheels

- 1 Stop the vehicle and close the throttle completely.
- 2 Select the gold image display. ➡ P.78
- 3 Select page 4. ➡ P.43

- 4 Press the **ENT** switch.
- 5 Select [ABS RR].
- 6 Press **▶** on the **◀ ▶** sel left/right switch to select [ACTIVE] (on).
 - ▶ The rear ABS OFF indicator flashes several times, and then off, when the ABS function on the rear wheel [ABS RR] is turned on [ACTIVE].



- 7 Press the  back switch.
You can also perform the above settings by using the touch screen.

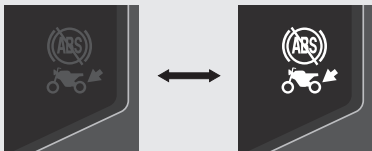

When the gold image is selected:



ABS function on both wheels is [ACTIVE] (on).

ABS function on rear wheel is [CANCEL] (off).

Available settings: [ACTIVE]/[CANCEL]

Default: [ACTIVE]

G switch

CRF1100D/D4

The G switch can change the engine characteristics of your vehicle to help improve traction and machine control for off-road riding by reducing the amount of clutch slip during throttle operation.

► Other than USER 1 and USER 2 MODE

Each time the ignition switch is turned to the ON position, the G switch [G] will automatically be set to default setting.





USER 1 and USER 2 MODE

The G switch [G] setting will be maintained even if the ignition switch is turned to the OFF position.

► The G switch [G] may not compensate for rough road conditions.

Always consider road and weather conditions, as well as your skills and condition, when applying throttle.

G switch on or off

- When using the  favorite switch.
 - ① Stop the vehicle and close the throttle completely.
 - ② Select [G Switch] of the  favorite switch.  **P.85**
 - ③ Press the  favorite switch.

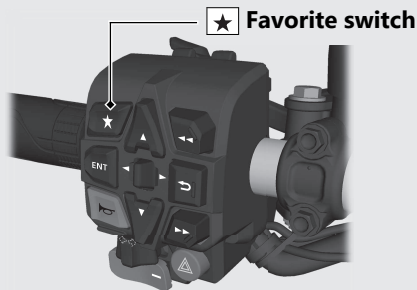

- When using the multi-information display:

- 1 Stop the vehicle and close the throttle completely.
- 2 Select the gold image display. ➡ P.78
- 3 Select page 4. ➡ P.43
- 4 Press the **ENT** switch.
- 5 Select [G].

- 6 Press ◀ on the ◀ ▶ sel left/right switch to select [CANCEL] (off). Press ▶ on the ◀ ▶ sel left/right switch to select [ACTIVE] (on).

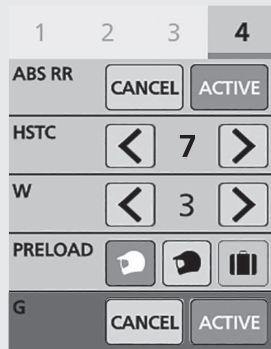

- 7 Press the ↶ back switch. You can also perform the above settings by using the touch screen.

G switch *(Continued)*

When the gold image is selected:

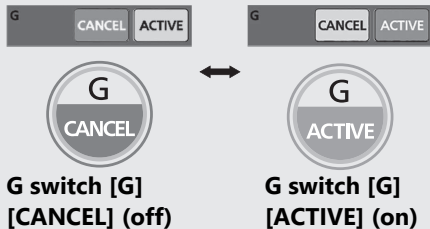

Available settings: [ACTIVE]/[CANCEL]

Default:

- [TOUR MODE]: [CANCEL]
- [URBAN MODE]: [CANCEL]
- [GRAVEL MODE]: [CANCEL]
- [OFF ROAD MODE]: [ACTIVE]
- [USER 1 MODE]: [CANCEL]
- [USER 2 MODE]: [CANCEL]

Parking Brake

CRF1100D/D4

Parking Brake Lever

Be sure the parking brake is applied while parking and warming up the engine.

- ▶ Make sure the parking brake lever is released before riding.

To apply the parking brake

Squeeze the parking brake lever (①) then fully rotate the lock lever (②) clockwise until it engages the slot on the parking brake lever bracket back to lock the rear wheel.

- ▶ The parking brake lock will not function if the parking brake is not adjusted properly.

➔ P.281

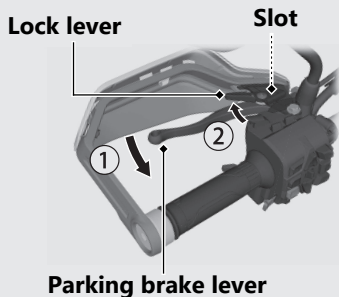

Parking brake lever

To release the parking brake

Squeeze the parking brake lever until the lock lever is released from the slot on the parking brake lever bracket.

- ▶ Before riding, check that the parking brake indicator is turned off and make sure that the parking brake is fully released so there is no drag on the rear wheel.

NOTICE

Riding with the parking brake applied will damage the rear brake components.

Handle Grip Heater

CRF1100A4/D4

This vehicle is equipped with a handle grip heater that warms up your hands during your ride.

Wear gloves to protect your hands from the heated grips.

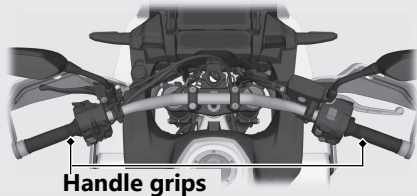

Handle grip heater indicator:

Comes on when the handle grip heater is on and indicates the selected heat level. The handle grip heater have 5 levels of heat to select.

Handle grip heater status icon: P.128

Displayed when the handle grip heater is on.

To operate handle grip heater

- 1 Start the engine. **➔ P.216**
- 2 Select the handle grip heater display of pop-up information using the **[Fn]** function sel switch.

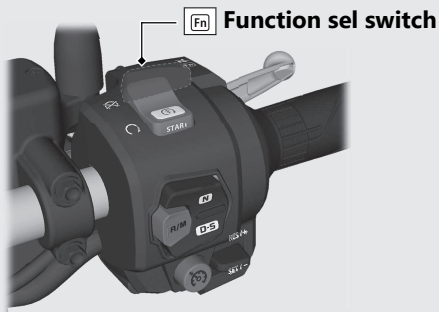

- 3 Push forward or pull backward the **[Fn]** function lever to select the handle grip heater level.

- ▶ The status icon will be appeared on the display when the handle grip heater operates.
- ▶ Do not leave the handle grip heater in the high position for a long time on a warm day.

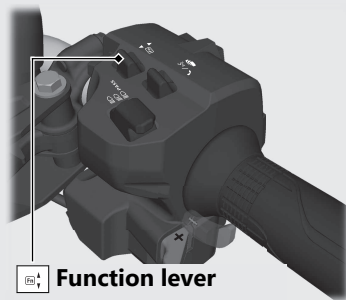

Handle Grip Heater *(Continued)*

To turn off handle grip heater

- 1 Select the handle grip heater display pop-up information using the **[Fn]** function sel switch.
- 2 Pull backward the **[Fn]** function lever several times to select the handle grip heater off.

Do not use the handle grip heater with the engine at idle for a long time. It may result in a low (or dead) battery.

Maintains the selected level when the ignition switch is turned to the OFF position.

- The heater level is not changed if the ignition switch is turned to the OFF position within 5 seconds after heater level changed.

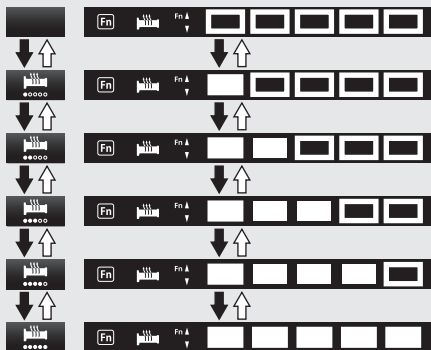

No indication (Off)

Level 1 lowest temperature

Level 2

Level 3

Level 4

Level 5 highest temperature

→ Push forward the **[Fn] function lever**

← Pull backward the **[Fn] function lever**

Honda Selectable Torque Control





Torque Control level (engine power control) can be selected or turned on/off.

- ▶ Do not change the Torque Control level while riding.
Stop the vehicle first, turn the Torque Control off or on and select the desired level.
- ▶ The Torque Control setting cannot be changed or turned off when the system is activated (Torque Control indicator flashing).





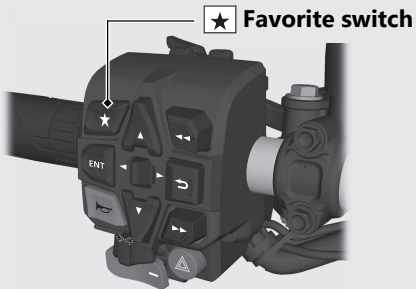

- ▶ In the following cases, the Torque Control will be turned on and the specific Torque Control level will automatically be set as below.
 - Each time the ignition switch is turned to the ON position, the Torque Control level will automatically be set to level it was set to. However, if the level was set to [0] (off), it will become level 1.
- ▶ When the Torque Control is turned from the [0] (off) position to the on position, it will automatically be set to level of before turning off the Torque Control.

Honda Selectable Torque Control (Continued)

Torque Control level setting

- When using the  favorite switch:
 - 1 Stop the vehicle.
 - 2 Select the [HSTC] of the  favorite switch.  P.85
 - 3 Press the  favorite switch.
 - ▶ 7: the maximum Torque Control level
 - ▶ 1: the minimum Torque Control level











- When using the multi-information display:
 - 1 Stop the vehicle.
 - 2 Select the gold image display.  P.78
 - 3 Select page 4.  P.43
 - 4 Press the **ENT** switch.
 - 5 Select [HSTC].
 - 6 Push the  or  of the   sel left/right switch to select your preferred level.



- 7 Press the  back switch.
- ▶ You can also perform the above settings by using the touch screen.

Torque Control on and off

- 1 Stop the vehicle.
- 2 Select the gold image display.  P.78
- 3 Select page 4.  P.43
- 4 Press the **ENT** switch.
- 5 Select [HSTC].
- 6 Press and hold  on the   sel left/right switch to set the [0] (off).
Press and hold  on the   sel left/right switch to set to level of before turning [0] (off) the Torque Control.

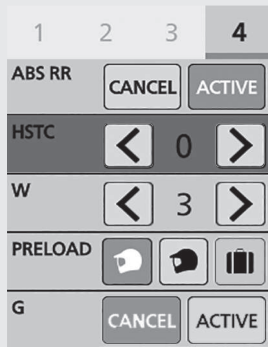

- 7 Press the  back switch.
- ▶ You can also perform the above settings by using the touch screen.

Setting range: Level 1 to 7 or 0 (Off)

Honda Selectable Torque Control (Continued)

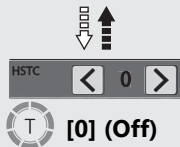
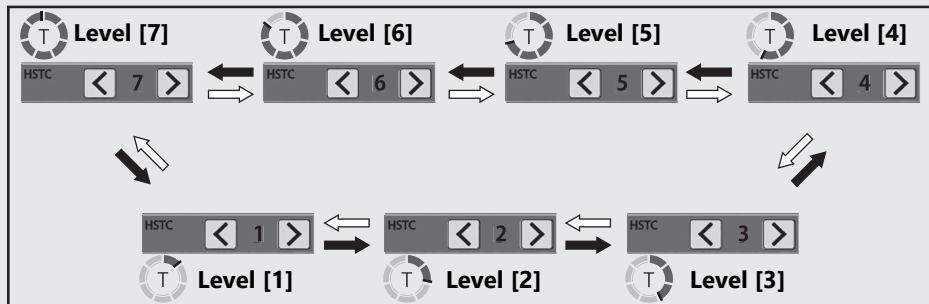

- Push on the sel left/right switch
- Push on the sel left/right switch or press the favorite switch
- Push and hold on the sel left/right switch
- Push and hold on the sel left/right switch

Wheelie Control





Wheelie Control level [W] can be selected or turned on/off.

- ▶ Do not change the wheelie control level [W] while riding.
Stop the vehicle first, then select the wheelie control level [W].





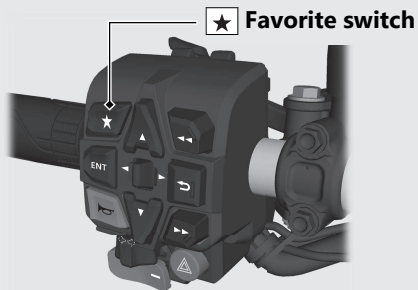

- ▶ In the following cases, the wheelie control [W] will be turned on and the specific wheelie control level [W] will automatically be set as below.
 - Each time the ignition switch is turned to the ON position, the wheelie control level [W] will automatically be set to level it was set to before. However, if the level was set to 0 (off), it will automatically be set to level before turning off the wheelie control level [W].
- ▶ When the wheelie control [W] is turned from the [0] (off) position to the on position, it will automatically be set to the level before turning off the wheelie control [W].

Wheelie Control *(Continued)*

Wheelie Control Level setting

- When using the  favorite switch:
 - 1 Stop the vehicle.
 - 2 Select the [Wheelie Control] of the  favorite switch.  **P.85**
 - 3 Press the  favorite switch.
 - ▶ 3: the maximum wheelie control level [W]
 - ▶ 1: the minimum wheelie control level [W]





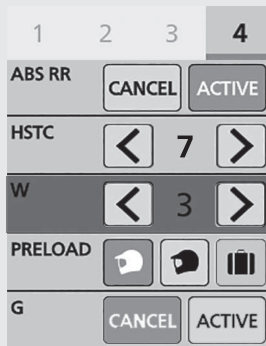





- When using the multi-information display:
 - 1 Stop the vehicle.
 - 2 Select the gold image display.  **P.78**
 - 3 Select page 4.  **P.43**
 - 4 Press the **ENT** switch.
 - 5 Select [W].
 - 6 Push the  or  of the   sel left/right switch to select your preferred level.



7 Press the  back switch.

You can also perform the above settings by using the touch screen.

Wheelie Control on and off

- 1 Stop the vehicle.
- 2 Select the gold image display.  P.78
- 3 Select page 4.  P.43
- 4 Press the **ENT** switch.
- 5 Select [W].
- 6 Press and hold  on the   sel left/right switch to set the [0] (off).
Press and hold  on the   sel left/right switch to set to level of before turning [0] (off) the wheelie control.

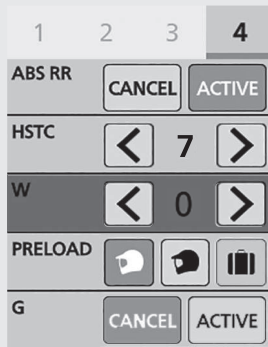

7 Press the  back switch.

You can also perform the above settings by using the touch screen.

Setting range: Level 1 to 3 or 0 (Off)

Wheelie Control *(Continued)*

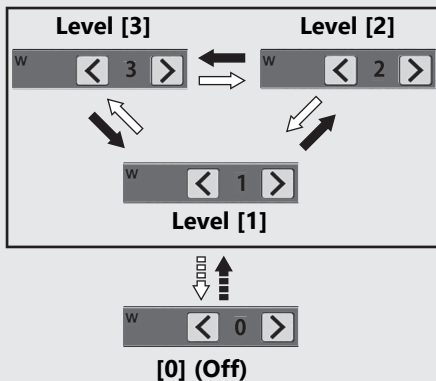

- Push on the sel left/right switch
- Push on the sel left/right switch or press the favorite switch
- Push and hold on the sel left/right switch
- Push and hold on the sel left/right switch

Riding mode

You can change the riding mode.
The riding mode consists of the following parameters.

[P] Power: Engine output level

[EB] Engine brake: Engine brake level

[ABS] ABS mode:

- [OFF ROAD]: Off road mode
- [ON ROAD]: On road mode

CRF1100A4/D4

[S] [Overall]: Suspension damping

[Front]: Suspension damping

[Rear]: Suspension damping

CRF1100D/D4

[G] G switch:  P.122

CRF1100A4/D4

[PRELOAD] [Preload]: Rear suspension preload

- (Rider): Rider only (Minimum preload)
- (Rider+Cargo): Rider and luggage
- (Rider+Passenger): Rider and passenger
- (Rider+Passenger+Cargo): Rider, passenger and luggage (Maximum preload)

Riding mode (Continued)

Current riding mode

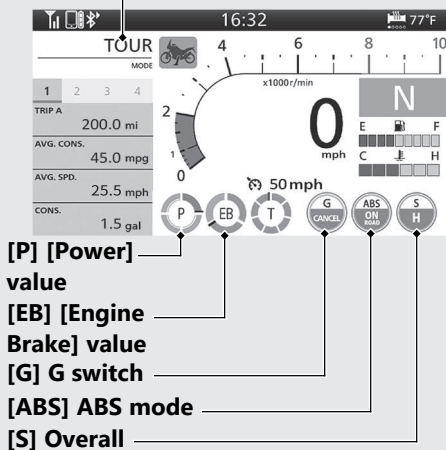

Riding mode has 6 modes.

Available riding modes: [TOUR MODE], [URBAN MODE], [GRAVEL MODE], [OFF ROAD MODE], [USER 1 MODE] and [USER 2 MODE]

[TOUR MODE], [URBAN MODE], [GRAVEL MODE] and [OFF ROAD MODE]

- ▶ **[TOUR MODE]**: Enables smooth acceleration even when riding with a passenger or a full load of luggage.
- ▶ **[URBAN MODE]**: Standard, all-round mode for a variety of situations.
- ▶ **[GRAVEL MODE]**: Good for stable riding on slippery surfaces such as dirt roads.
- ▶ **[OFF ROAD MODE]**: Suitable for enjoying off-road sports riding.

Each initial setting value cannot be changed.

[USER 1 MODE] and **[USER 2 MODE]**

Each initial setting value can be changed.

Initial setting

Riding modes	[P] [Power] value	[EB] [Engine Brake] value	Suspension damping			[ABS] ABS mode	[G] G switch *2
			[S] [Overall] *1	[Front] *1	[Rear] *1		
[TOUR MODE]	1	2	H	Medium	Medium	ON ROAD	CANCEL*3
[URBAN MODE]	2	2	M	Medium	Medium	ON ROAD	CANCEL*3
[GRAVEL MODE]	4	3	S	Medium	Medium	OFF ROAD	CANCEL*3
[OFF ROAD MODE]	3	3	O	Medium	Medium	OFF ROAD	ACTIVE*3
[USER 1 MODE]	2*3	2*3	M*3	Medium*3	Medium*3	ON ROAD*3	CANCEL*3
[USER 2 MODE]	4*3	3*3	S*3	Medium*3	Medium*3	OFF ROAD*3	CANCEL*3

Notes:

*1 : CRF1100A4/D4

*2 : CRF1100D/D4

*3 : Value can be changed.

Riding mode *(Continued)*

Riding modes	[PRELOAD] [Preload] (Rider) *1	[PRELOAD] [Preload] (Rider+ Cargo) *1	[PRELOAD] [Preload] (Rider+ Passenger) *1	[PRELOAD] [Preload] (Rider+ Passenger+ Cargo) *1
[TOUR MODE]	5	10	15	20
[URBAN MODE]	5	10	15	20
[GRAVEL MODE]	5	10	15	20
[OFF ROAD MODE]	5	10	15	20
[USER 1 MODE]	5*2	10*2	15*2	20*2
[USER 2 MODE]	5*2	10*2	15*2	20*2

Notes:

*1 : CRF1100A4/D4

*2 : Value can be changed.

[P] Power value (Engine output level)

[P] Power value has four setting levels.

Available setting range: 1 to 4

- ▶ Level 1 has the maximum power.
- ▶ Level 4 has the minimum power.

[EB] Engine brake value (Engine brake level)

EB value has three setting levels.

Available setting range: 1 to 3

- ▶ Level 1 has the strongest engine braking effect.
- ▶ Level 3 has the weakest engine braking effect.

[S] Overall: suspension damping

CRF1100A4/D4

[S] Overall value has four setting levels.

Available setting range: [H] Hard / [M]

Medium / [S] Soft / [O] Off Road

- ▶ [H] Hard has the maximum suspension damping.
- ▶ [S] Soft has the minimum suspension damping.
- ▶ [O] Off Road is for off road settings.

[Front]: suspension damping

CRF1100A4/D4

[Front] has three setting levels.

Available setting range: - / Medium / +

- ▶ + has the maximum suspension damping.
- ▶ - has the minimum suspension damping.

Riding mode *(Continued)*

[Rear]: suspension damping

CRF1100A4/D4

[Rear] has three setting levels.

Available setting range: - / Medium / +

- ▶ + has the maximum suspension damping.
- ▶ - has the minimum suspension damping.

ABS mode [ABS]

ABS mode [ABS] has two setting levels.

Available setting range: [OFF ROAD] or [ON ROAD]

- ▶ [OFF ROAD] is for off road settings.
- ▶ [ON ROAD] is for on road settings.

[G] G switch P.122

CRF1100D/D4

[PRELOAD] [Preload] (Rider), (Rider + Cargo), (Rider+Passenger) and (Rider + Passenger+ Cargo): rear suspension preload

CRF1100A4/D4

[PRELOAD] [Preload] Preload has twenty four setting levels.

Available setting range: 1 to 24

- ▶ Level 24 has the maximum suspension preload.
- ▶ Level 1 has the minimum suspension preload.

Selecting the riding mode

When changing the riding mode, the rear wheel ABS function [ABS RR] will automatically be set to [ACTIVE].

- When using the ▲ sel up switch and ▼ sel down switch:
 - 1 Press the ▲ sel up switch or ▼ sel down switch.

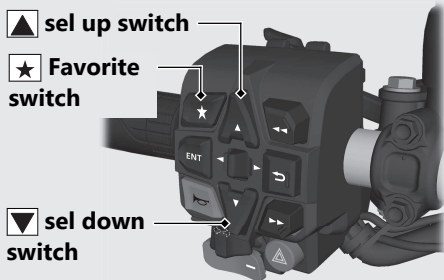

You can also perform the above settings by using the touch screen.

- When using the ★ favorite switch:
 - 1 Select the [Riding Mode] of the ★ favorite switch. ➔ P.85
 - 2 Press the ★ favorite switch.

Riding mode *(Continued)*

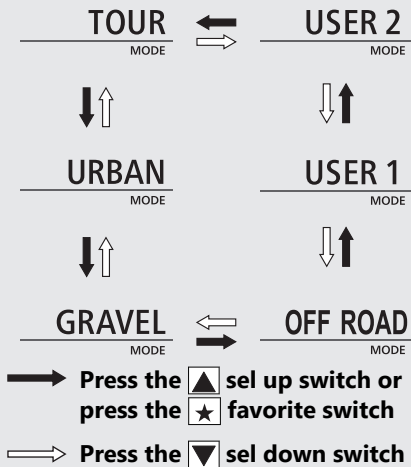

Setting the riding mode

You can change the [P] [Power], [EB] [Engine Brake], [S] [Overall], [Front], [Rear], ABS mode [ABS] and [PRELOAD] [Preload] on the [USER 1 MODE] and [USER 2 MODE] of the riding mode.  **P.74**

Audio System

About Your Audio System

This audio system can play audio files on *Bluetooth*® audio devices (mobile phone, digital audio player or equivalents).

The audio system can pair with *Bluetooth*® sound devices (speakers, headsets, communication devices or equivalents).

You can operate the audio system from the switches on the left handlebar and multi-information display. However, you cannot operate some functions by the touch screen while the vehicle is in motion.

- Local laws may prohibit the operation of handheld electronic devices while operating a vehicle.
- Only operate audio switches when safe to do so.

- Set the volume at a level that still allows horns and emergency vehicles to be heard.
- Some audio devices, iPhone, **Android**™ phone and *Bluetooth*® sound devices may not be compatible.
- We shall not be liable for any damages or trouble in the use of audio device.
- iPhone, iPad, iPad Air, iPad Mini, iPod, iPod touch, iPod classic, iPod shuffle and iPod nano are trademarks of Apple Inc.
- **Google**™ and **Android Auto**™ are trademarks of **Google** LLC.

Audio System *(Continued)*

About *Bluetooth*® audio

- Only one *Bluetooth*® audio device and two *Bluetooth*® sound devices can be paired with the audio system at a time. When another device is paired, the information on the previously registered device is cancelled.
- If you receive a call to a paired phone while playing audio, the paired phone may stop playing.
- When unable to connect your *Bluetooth*® device to the audio system or when sounds skip or noises mix while playing, change the storage location of the *Bluetooth*® device.

Bluetooth® Wireless Technology

The *Bluetooth*® word mark and logos are registered trademarks owned by Bluetooth

SIG, Inc., and any use of such marks by Honda Motors Co., Ltd., is under license. Other trademarks and trade names are those of their respective owners.

Audio System Location

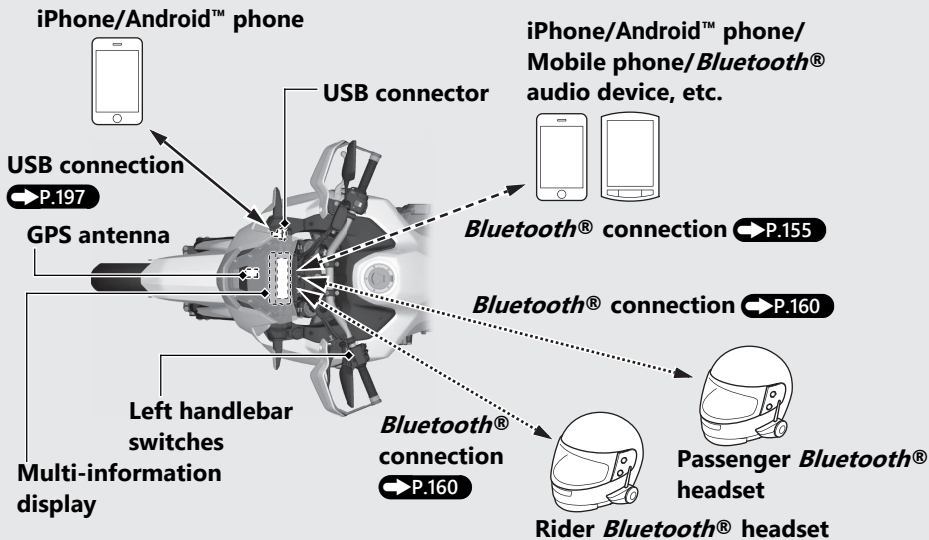

Audio System *(Continued)*

↔ **USB connection for Apple CarPlay/Android Auto™**

↔ **Audio system supported profiles:**

- HFP ver. 1.5
- A2DP ver. 1.2
- AVRCP ver. 1.4
- PBAP ver. 1.0

↔ **Headset supported profiles:**

- HFP ver. 1.7
- A2DP ver. 1.2

Basic Operations

You can operate and set the various functions of the audio system using the touch screen and/or switches on the left handlebar. However, you cannot operate some functions by the touch screen while the vehicle is in motion.

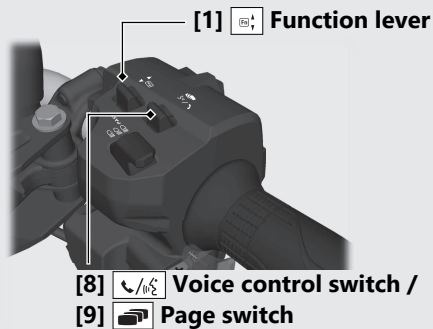

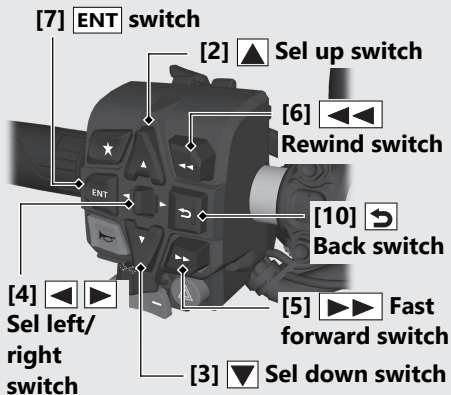



- [1] Function lever: Push forward or pull backward the lever to adjust the volume.
- To increase the volume: Push forward the lever.
 - To decrease the volume: Pull backward the lever.
 - To increase the volume rapidly: Push forward and hold the lever.
 - To decrease the volume rapidly: Pull backward and hold the lever.
- [2] Sel up switch: Press the switch to select a menu item.
- [3] Sel down switch: Press the switch to select a menu item.
- [4] Sel left/right switch: Press the switch to select a menu item.
- [5] Fast forward switch:
- To skip to the next song: Press the switch.
 - To move rapidly within a track: Press and hold the switch.

Audio System *(Continued)*

[6]  Rewind switch:

- To go back to the beginning of the current or previous song: Press the switch.
- To move rapidly within a track: Press and hold the switch

[7]  switch: Press to set your selection.

[8]  Voice control switch:

- To receive or end a call: Push forward on the switch.
- To reject a call: Push forward and hold the switch.
- To start Siri or voice search when Apple CarPlay or **Android Auto™** is available: Push forward on the switch.

[9]  Page switch:

- To return to the riding information or audio screen: Pull backward on the switch.
- To return to the home screen, Apple CarPlay screen or voice search screen: Pull backward and hold the switch.

[10]  Back switch:

- To return to the previous screen: Press the switch.
- To return to the audio screen: Press and hold the switch.

To Adjust the Volume

You can adjust the volume settings for the headsets.

The system has the following unique volume levels.

Adjust the volume while in the individual modes.

- [Music] Rider
- [Music] Passenger
- [Phone]
- [System]
- [Ringtone]
- [Voice]
- [Microphone]

Each volume can also be set from the menu.

➔ P.92

When you push forward or pull backward the  function lever, the volume control level appears on the pop-up information.

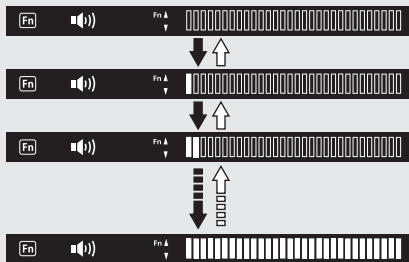



➔ Push forward on the  function lever

➔ Pull back on the  function lever

Audio System *(Continued)*

To increase the volume: push forward on the  function lever.

- ▶ To increase the volume rapidly, push forward and hold the  function lever.

To decrease the volume: pull back on the  function lever.

- ▶ To decrease the volume rapidly, pull back and hold the  function lever.

Volume level range:

Other than Microphone: Level 0 to 30

Microphone: Level 0 to 14

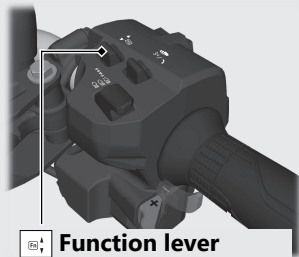

Auto Volume

Selects the volume setting to automatically increase volume from the headsets as the speed of the vehicle increases.

To select the Auto Volume:  **P.92**

Available settings: [Off]/[Low]/[High]

Default: [Off]

Bluetooth® Audio

Bluetooth® Setting

You can connect with your *Bluetooth®* audio device (mobile phone, digital audio player or equivalents) and *Bluetooth®* headsets via *Bluetooth®*.

Available devices are as follows:

- [Phone Pairing] (For *Bluetooth®* audio device) ➡ **P.155**
- [Headset Pairing] (For rider headset and passenger headset) ➡ **P.160**

Audio System *(Continued)*

Supported *Bluetooth*[®] version/profiles

<i>Bluetooth</i> [®] version	Bluetooth 2.1 + EDR
<i>Bluetooth</i> [®] profiles (For iPhone, Android [™] phone, mobile phone or <i>Bluetooth</i> [®] device)	HFP (Hand Free Profile) ver. 1.5
	A2DP (Advanced Audio Distribution Profile) ver. 1.2
	AVRCP (Audio/Video Remote Control Profile) ver. 1.4
<i>Bluetooth</i> [®] profiles (For rider and passenger headsets)	PBAP (Phone Book Access Profile) ver. 1.0
	HFP (Hand Free Profile) ver. 1.7
	A2DP (Advanced Audio Distribution Profile) ver. 1.2

- You cannot pair a *Bluetooth*[®] device and *Bluetooth*[®] headsets while the vehicle is moving. When pairing, park your vehicle in a safe place.
- *Bluetooth*[®] connection cannot be established while launching Apple CarPlay.
- Your vehicle is not equipped with an intercom function. If you want to use the intercom function, use the intercom function of your headset.
- Some local governments prohibit the use of a headset by the operator of a motor vehicle. Always obey applicable laws and regulations.

Phone Pairing

You can establish a *Bluetooth*® connection in two ways.

- [Discoverable]: Search from the device.
- [Phone Pairing]: Search from the system.

This function is disabled while the vehicle is in motion.

- 1 Enable the *Bluetooth*® function on your device.
 - ▶ For details, refer to the instruction manual of your device.
- 2 Select [Bluetooth], and then press the **ENT** switch.

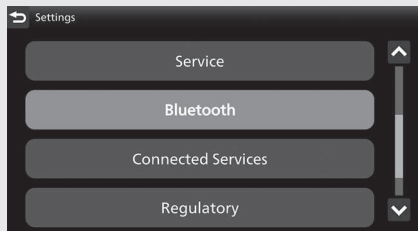

Audio System *(Continued)*

- 3 Select [Bluetooth], and then press the **ENT** switch to [ON] (enable) the function.

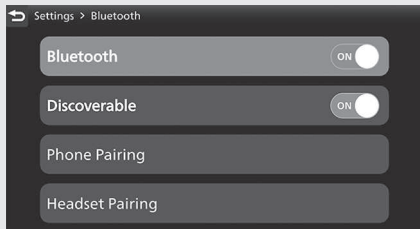

[Discoverable]

- 4 Select [Discoverable], and then press the **ENT** switch to [ON] (enable) the function.

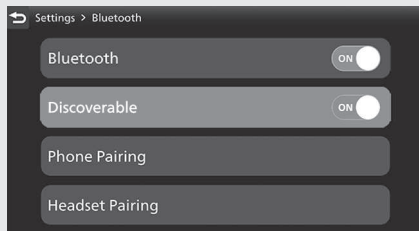

- 5 Tap "Honda Motorcycle #*****" on the *Bluetooth*® setting menu of the target device.
 - ▶ The wildcard "#*****" will be different for each vehicle.
- 6 When a request message appears on the target device, tap "Pair."

- 7 The device name and Passkey appear on the screen. Select [Yes], and then press the **ENT** switch.

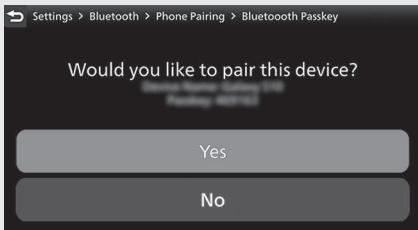

- 8 When the pairing is complete, the name of the paired device are displayed.
Icon status:

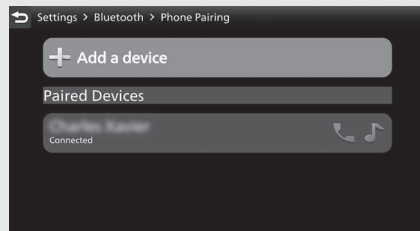
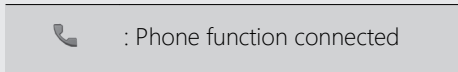

- 9 Return to the riding information, previous screen or Home screen. **→ P.38**
You can also perform the above settings by using the touch screen.

Audio System *(Continued)*

[Phone Pairing]

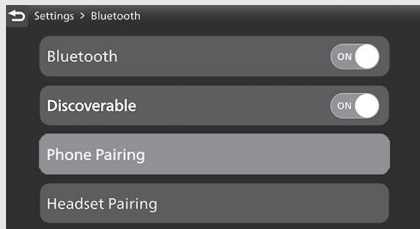

- 4 Select [Phone Pairing], and then press the **ENT** switch.

- 5 Select [+Add a device], and then press the **ENT** switch.

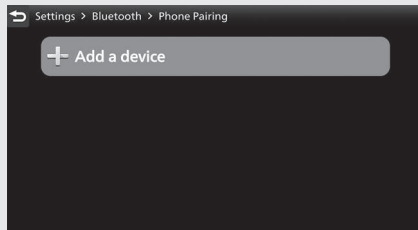

- 6 The names of the detected device are displayed.
- ▶ If many *Bluetooth*® devices are detected, the target device may be detected under the list, scroll down the list.

- 7 Select a target device name, and then press the **ENT** switch.

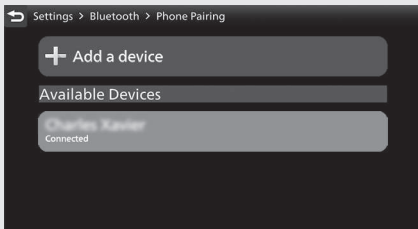

- 8 Select [Yes], and then press the **ENT** switch.

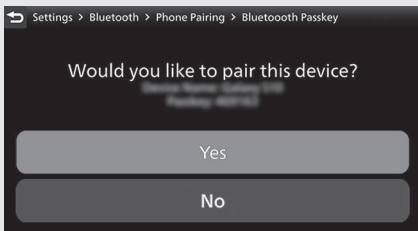

- 9 When a request message appears on the target device, tap "Pair."
- 10 When the pairing is complete, the name of the paired device are displayed.
Icon status:

 : Phone function connected

 : Music function connected

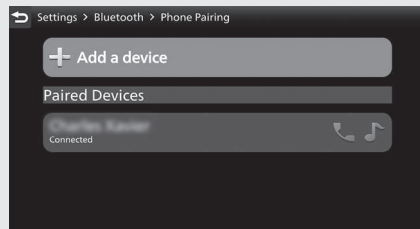

- 11 Return to the riding information, previous screen or Home screen. **➡ P.38**

Audio System *(Continued)*

You can also perform the above settings by using the touch screen.

To disconnect the phone: ➔ P.163

Headset Pairing

This function is disabled while the vehicle is in motion.

- 1 Enable the *Bluetooth*® function on your device.
 - ▶ For details, refer to the instruction manual of your device.
- 2 Select [Bluetooth], and then press the **ENT** switch.

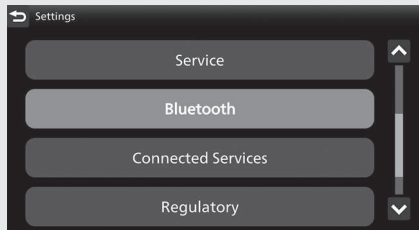

- 3 Select [Bluetooth], and then press the **ENT** switch to [ON] (enable) the function.

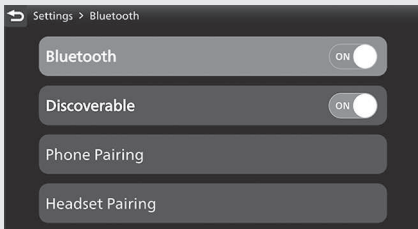

- 4 Select [Headset Pairing], and then press the **ENT** switch.

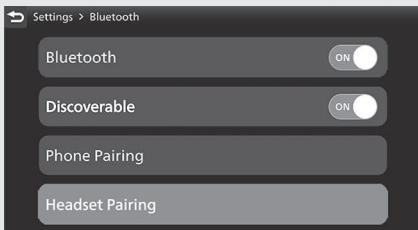

- 5 Select [+ Add a device], and then press the **ENT** switch.

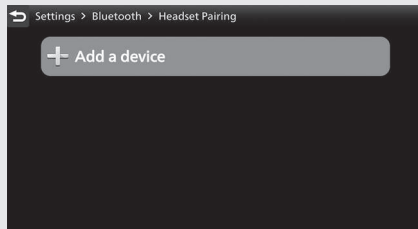

- 6 The names of the detected device are displayed.
- ▶ If many *Bluetooth*® devices are detected, the target device may be detected under the list, scroll down the list.

Audio System *(Continued)*

- 7 Select a target device name, and then press the **ENT** switch.

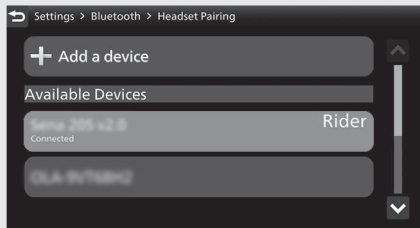

- 8 When the pairing is complete, device name is displayed.

Rider	When pairing rider headset
Passenger	When pairing passenger headset

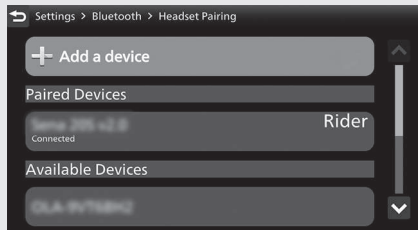

- 9 Return to the riding information, previous screen or Home screen. ➡ **P.38**

You can also perform the above settings by using the touch screen.

To disconnect the headset: ➡ **P.163**

To Reconnect a Paired Device Automatically

When the ignition switch is turned ON position, the system reconnects with registered devices automatically.

- ▶ If the system finds multiple paired devices, the system will reconnect with the device that was connected last.
- ▶ After reconnecting, the song that was last played will be played automatically.

To Connect/Disconnect Available Functions Individually

Depending on the connected device, this function may not be able to establish a connection.

- 1 Select [Bluetooth], and then press the **ENT** switch.

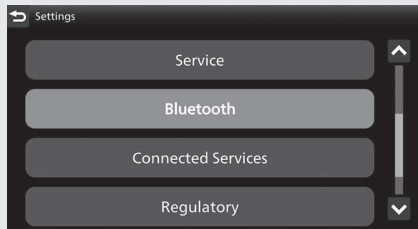

Audio System *(Continued)*

To connect functions:

2 [Phone Pairing]

1. Select [Phone Pairing], and then press the **ENT** switch to enter the setting menu.

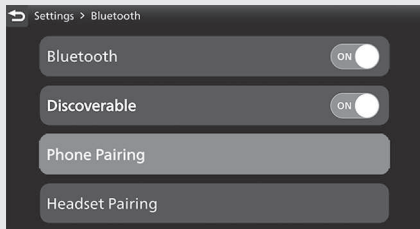

2. Select the paired device, and then press the **ENT** switch.

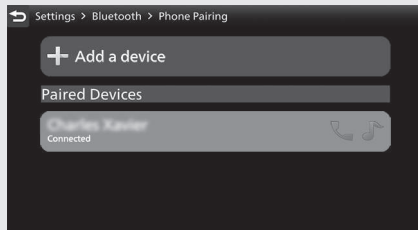

3. Select [Connect a Phone] or [Connect Music], and then press the **ENT** switch to [ON] (enable) the function.

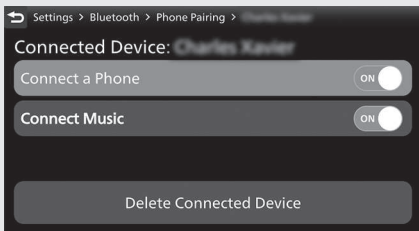

- 2 [Headset Pairing]
 1. Select [Headset Pairing], and then press the **ENT** switch to enter the setting menu.

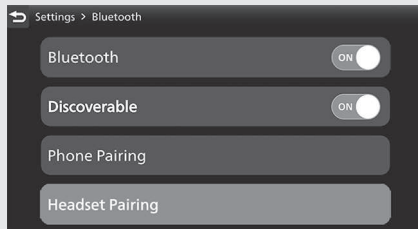

Audio System *(Continued)*

2. Select the paired device, and then press the **ENT** switch.

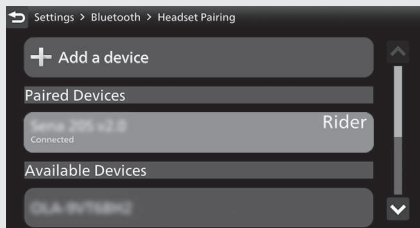

3. Select [Designate as a Rider] or [Connect Headset], and then press the **ENT** switch to [ON] (enable) the function.

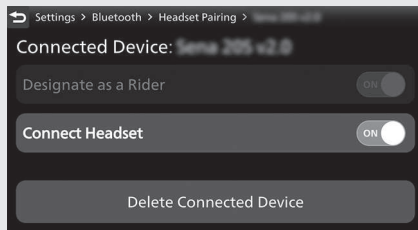

- 3 Return to the riding information, previous screen or Home screen. ➡ **P.38**

You can also perform the above settings by using the touch screen.

To disconnect functions:

2 [Phone Pairing]

1. Select [Phone Pairing], and then press the **ENT** switch to enter the setting menu.

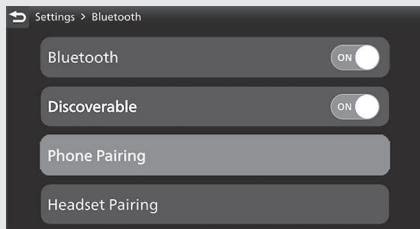

2. Select the paired device, and then press the **ENT** switch.

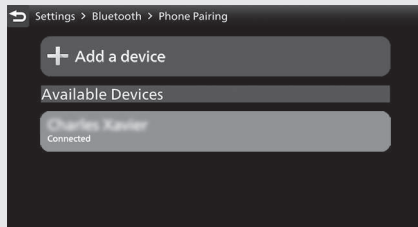

Audio System *(Continued)*

3. Select [Connect a Phone] or [Connect Music], and then press the **ENT** switch to [OFF] (disable) the function.

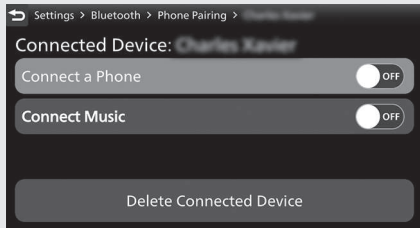

2 [Headset Pairing]

1. Select [Headset Pairing], and then press the **ENT** switch to enter the setting menu.

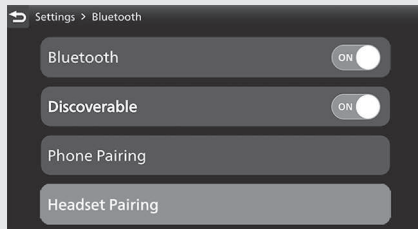

2. Select the paired device, and then press the **ENT** switch.

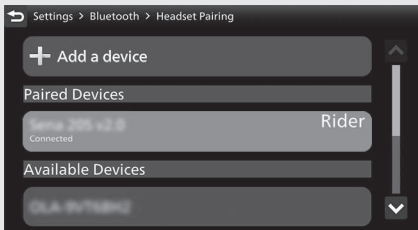

3. Select [Designate as a Rider] or [Connect Headset], and then press the **ENT** switch to [OFF] (disable) the function.

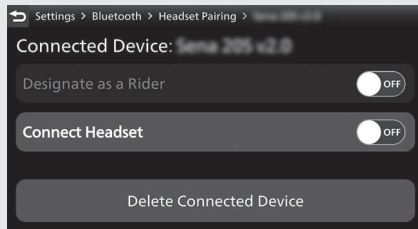

- 3 Return to the riding information, previous screen or Home screen. ➡ **P.38**
- You can also perform the above settings by using the touch screen.

Audio System *(Continued)*

To Delete Connected Device

- 1 Select [Bluetooth], and then press the **ENT** switch.

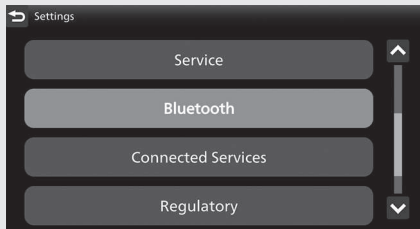

- 2 Select [Phone Pairing] or [Headset Pairing], and then press the **ENT** switch to enter the setting menu.

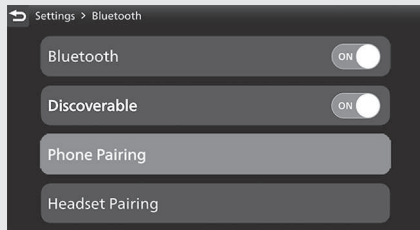

- 3 Select the paired device, and then press the **ENT** switch.

- 4 Select [Delete Connected Device], and then press the **ENT** switch.

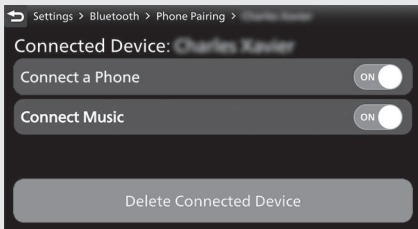

- 5 The name of the device disappears from the screen.

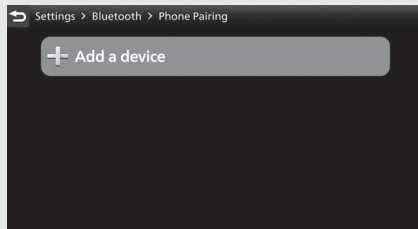

- 6 Return to the riding information, previous screen or Home screen. ➡ **P.38**
- You can also perform the above settings by using the touch screen.

Audio System (Continued)

Playing Audio

The audio system can play music stored on a device connected via *Bluetooth*®.

[3] Album title

[2] Artist name

[1] Song title

[5] Progress bar

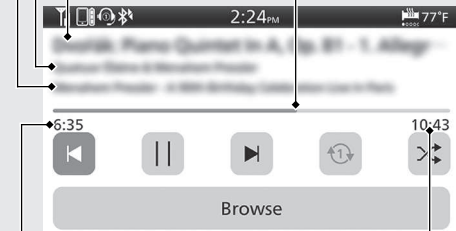

[4] Play time

[6] Total time

Screen Information

The information displayed on the screen differs depending on the connected device and the type of file being played back.

The system supports ID3 tag information. If a track does not have an ID3 tag, the song title or file name is displayed.

[1] Song title

[2] Artist name

[3] Album title (Folder name)

[4] Play time

[5] Progress bar

[6] Total time

To Play a Track

- 1 Connect the device you want to play from.
Bluetooth® setting: ➔ P.163
- 2 Select [Media], and then press the **ENT** switch.

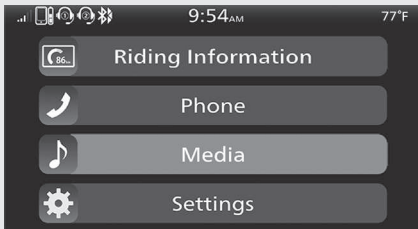

- 3 Select **[▶]**, and then press the **ENT** switch.

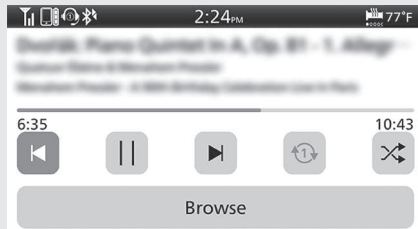

- 4 Return to the riding information, previous screen or Home screen. ➔ P.38





You can also perform the above settings by using the touch screen.

Audio System *(Continued)*

To Pause a Track

Select , and then press the **ENT** switch. You can also perform the above settings by using the touch screen.

To Change a Track

- To skip to the next song: Press the  Fast forward switch.
- To move rapidly within a track: Press and hold the  Fast forward switch.
- To go back to the beginning of the current or previous song: Press the  Rewind switch.
- To move rapidly within a track: Press and hold the  Rewind switch.

You can also perform the above settings by using the touch screen.

To Select the Play Mode

You can select repeat and random modes. The audio play mode status icon or color of the audio play mode status icon changes.



Cycles through the play modes as follows:
Select , and then press the **ENT** switch.



(Black) No repeat mode: No repeat.



(Blue) Album repeat play mode:
Repeats all tracks in the current playlist ([Artists], [Albums] or [Songs], etc.).



(Blue) Track repeat play mode:
Repeats the current track.

Audio System *(Continued)*

Select , and then press the **ENT** switch.



(Black) Normal play mode: Plays tracks in original order.



(Blue) Random play mode: Plays tracks randomly.

You can also perform the above settings by using the touch screen.

Handsfree Calling

Using *Bluetooth*® Handsfree Calling

Bluetooth® handsfree calling allows you to make and receive phone calls using your vehicle's audio system, without handling your mobile phone.

To use the handsfree calling, you need a *Bluetooth*® compatible mobile phone and *Bluetooth*® headsets.

- You cannot operate the handsfree calling functions by the touch screen while the vehicle is in motion.
- If *Bluetooth*® connection is unstable due to surrounding conditions or radio wave conditions, the handsfree calling functions may not be available.

- While talking, you may be hard to hear due to wind noise during running or external noise. In that case, try to change the position of the microphone or to adjust the windscreen height. **➡ P.303**

Audio System *(Continued)*

Preparation

- 1 Connect with the paired mobile phone. **➔ P.155**
 - ▶ The phonebook is updated after every connection. Call history is updated after every connection or call.
- 2 Connect the paired rider headset. **➔ P.160**
- 3 Select [Phone], and then press the **ENT** switch.

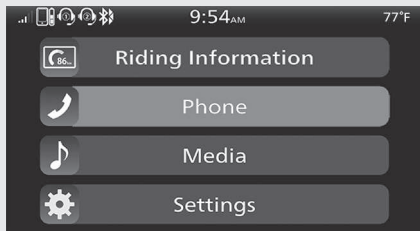

- 4 Return to the riding information, previous screen or Home screen. **➔ P.38**
You can also perform the above settings by using the touch screen.

Making a Call

You can make calls by inputting a phone number or by using the phonebook, call history or speed dial entries.

To change the call mode, push or on the sel left/right switch.

Changes the call modes as follows:

[Call History] [Speed Dial] [Contacts] [Dial Number] [Settings]

- Certain manual functions are disabled while the vehicle is in motion. You cannot select a greyed-out option until the vehicle is stopped.
- Only previously stored speed dial entries and call history can be called while the vehicle is in motion.

To adjust the phone volume: ➔ P.92

To Make a Call Using the Call History [Call History]

You can make a call using the call history while the vehicle is in motion.

Call history displays the last 30 dialed, received, or missed calls.

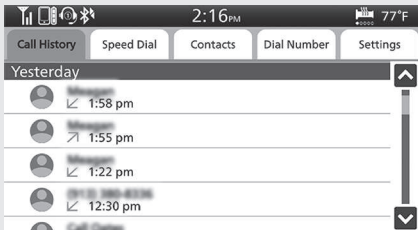

- 1 Select [Call History].
- 2 Select the phone number you want to call, and then press the **ENT** switch.

 (blue): Dialed call

 (blue): Received call

 (red): Missed call

- 3 To end the call, push forward the  voice control switch on the left handlebar.
 - ▶ The same action can be done by selecting [End Call] on the screen.
- 4 Return to the riding information, previous screen or Home screen. **➡ P.38**

You can also perform the above settings by using the touch screen.

Audio System *(Continued)*

To Make a Call Using a Speed Dial Entry [Speed Dial]

You can make a call using the speed dial while the vehicle is in motion.

To make a call using the speed dial, you need to store the speed dial number in advance. ➡ **P.183**

Up to 20 speed dial numbers can be stored.

- 1 Select [Speed Dial].
- 2 Select a person you want to call, and then press the **ENT** switch.
Dialing starts automatically.

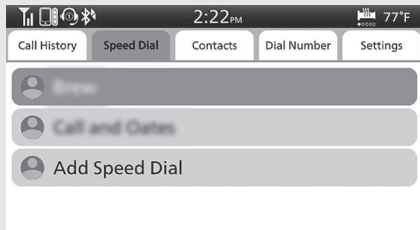

- 3 To end the call, push forward the  voice control switch on the left handlebar.
 - ▶ The same action can be done by selecting [End Call] on the screen.
- 4 Return to the riding information, previous screen or Home screen. ➡ **P.38**



You can also perform the above settings by using the touch screen.

To Make a Call Using the Phonebook [Contacts]

This function is disabled while the vehicle is in motion.

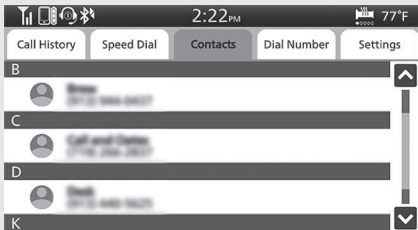
- 1 Stop the vehicle.
- 2 Select [Contacts].
- 3 The phonebook is stored alphabetically.
Select a name, and then press the **ENT** switch to set your selection.
- 4 Select the phone number you want to call, and then press the **ENT** switch.



- 5 To end the call, push forward the  voice control switch on the left handlebar.
 - ▶ The same action can be done by selecting [End Call] on the screen.
- 6 Return to the riding information, previous screen or Home screen.  **P.38**

You can also perform the above settings by using the touch screen.

Audio System *(Continued)*



To Make a Call Using a Phone Number [Dial Number]

This function is disabled while the vehicle is in motion.

- 1 Select [Dial Number].
- 2 Press the ▲ sel switch or ▼ sel switch or push ◀ or ▶ on the ◀ ▶ sel left/right switch to enter a number, and then press the ENT switch to set the number.
 - ▶ When using [+]: Select [0], and then press and hold the ENT switch.

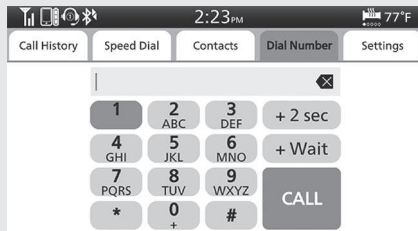
- 3 Select [CALL], and then press the ENT switch to make a call.
 - ▶ To cancel the call, press the ENT switch.
 - ▶ When making a call 1 second after the ENT switch pressed: Select [+ Wait], and then press the ENT switch.
 - ▶ When making a call 2 seconds after the ENT switch pressed: Select [+ 2 sec], and then press the ENT switch.



- 4 To end the call, push forward the  voice control switch on the left handlebar.
 - ▶ The same action can be done by selecting [End Call] on the screen.
- 5 Return to the riding information, previous screen or Home screen.  **P.38**

You can also perform the above settings by using the touch screen.

To Store a Phone Number in the Speed Dial List

Speed dial numbers can be stored.

- 1 Select [Speed Dial].
- 2 Select [Add Speed Dial], and then press the **ENT** switch.

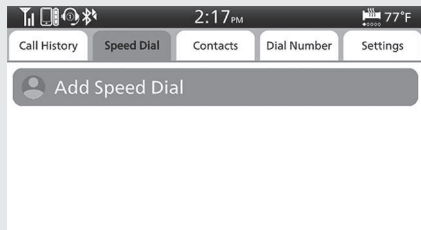

- 3 The phonebook appears.

Audio System *(Continued)*

- 4 Select the phone number you want to store, and then press and hold the **ENT** switch. The phone number will be stored in the speed dial list.

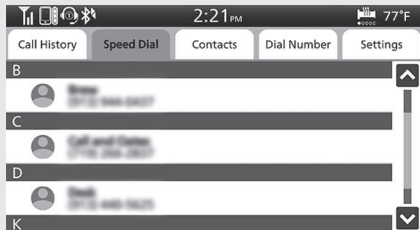

- 5 Return to the riding information, previous screen or Home screen. **➡ P.38**
You can also perform the above settings by using the touch screen.

To Delete a Stored Speed Dial Number

- 1 Select [Settings].
- 2 Select the [Edit Speed Dial], and then press the **ENT** switch.

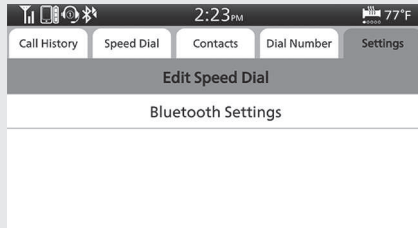

- 3 Select the phone number you want to delete, and then press and hold the **ENT** switch.

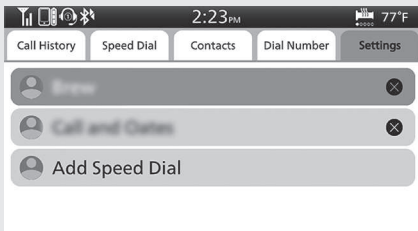

- 4 Return to the riding information, previous screen or Home screen. **→P.38**
- You can also perform the above settings by using the touch screen.

Receiving a Call

When there is an incoming call, an audible notification sounds and the Incoming Call screen appears.

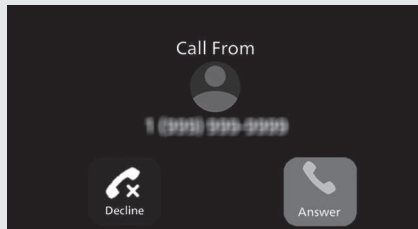

Audio System *(Continued)*

Ring Tone

If the connected mobile phone supports “in band ring tone”, the ring tone stored on the phone sounds automatically while receiving a call.

If “in band ring tone” is not supported, the ring tone stored in the audio system sounds.

To Receive a Call

When a call comes in, push forward on the  voice control switch on the left handlebar to receive the call.

- The same action can be done by selecting [Answer] on the screen.

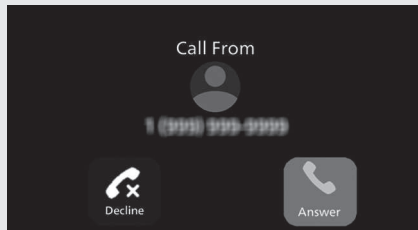

To adjust the phone volume:  **P.92**

To Decline a Call

When a call comes in, push forward and hold the  voice control switch on the left handlebar to reject a call.

- The same action can be done by selecting [Decline] on the screen.

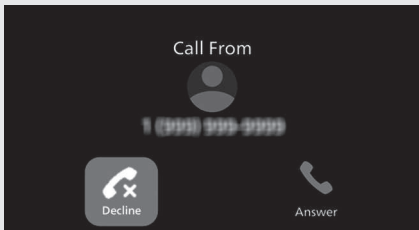

To End a Call

While talking, push forward on the  voice control switch on the left handlebar to end the call.

- The same action can be done by selecting [End Call] on the screen.

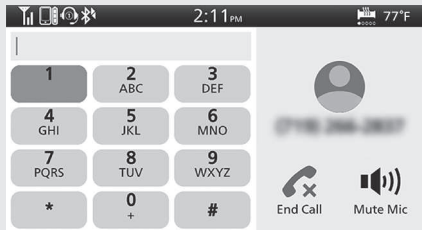

Audio System *(Continued)*

Apple CarPlay

If you connect an Apple CarPlay-compatible iPhone to the system via USB, you can use the multi-information display, instead of the iPhone display, to make phone calls, listen to music, view maps (navigation), and access messages.

- Only iPhone 5 or newer versions with iOS 10 or later are compatible with Apple CarPlay.
- Park your vehicle in a safe place before connecting your iPhone to Apple CarPlay and when launching any compatible apps.
- In no event shall Honda be liable for any damage or trouble that occurs in the use of iPhone.
- If a mobile network communication is unstable due to surrounding conditions or signal strength conditions, Apple CarPlay functions may not be available.
- To use Apple CarPlay, a headset connection is necessary. If headset connection is broken due to headset battery depletion or communication failure, Apple CarPlay cannot be used until the connection is restored.
- You cannot operate Apple CarPlay by the touch screen while the vehicle is in motion.

- Application and menu items displayed on the screen may differ depending on the connected device and iOS version.
- While connected to Apple CarPlay, calls are only made through Apple CarPlay. If you want to make a call with *Bluetooth*® handsfree calling, disconnect the USB cable from your iPhone and connect your iPhone via *Bluetooth*®.
- For details on countries and regions where Apple CarPlay is available, as well as information pertaining to function, refer to the Apple homepage.
- Apple CarPlay is a trademark of Apple Inc.

To connect the paired device:

➡ P.155

Audio System *(Continued)*

Apple CarPlay Operating Requirements & Limitations

Apple CarPlay requires a compatible iPhone with an active cellular connection and data plan. Your carrier's rate plans will apply.

Changes in operating systems, hardware, software, and other technology integral to providing Apple CarPlay functionality, as well as new or revised governmental regulations, may result in a decrease or cessation of Apple CarPlay functionality and services. Honda cannot and does not provide any warranty or guarantee of future Apple CarPlay performance or functionality.

It is possible to use 3rd party apps if they are compatible with Apple CarPlay. Refer to the Apple homepage for information on compatible apps.

Use of User and Vehicle Information

The use and handling of user and vehicle information transmitted to/from your iPhone by Apple CarPlay is governed by the Apple iOS terms and conditions and Apple's Privacy Policy.

| To Setup Apple CarPlay

Use of Apple CarPlay will result in the transmission of certain user and vehicle information (such as vehicle location, speed, and status) to your iPhone to enhance the Apple CarPlay experience. You will need to consent to the sharing of this information on the screen.

- 1 Pair the headsets. ➔ **P.160**
- 2 Connect your iPhone using a certified cable to the USB socket. ➔ **P.197**
 - ▶ If the following screen is displayed, Apple CarPlay can not be used, but USB power can be supplied.
 1. Select [OK], and then press the **ENT** switch.

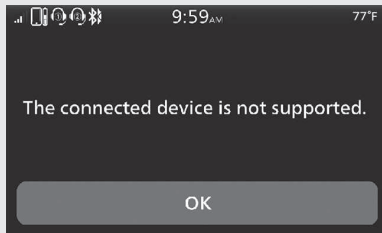

To enable Apple CarPlay: ➔ **P.193**

Audio System *(Continued)*

- 3 When the disclaimer message appears on the screen, select [Enable], and then press the **[ENT]** switch.
 - ▶ Set [Remember My Choice] to ON so that you will not be asked the next time you connect.

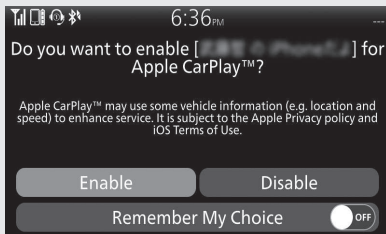

[Enable] when [Remember My Choice] is [OFF]: Allows only once. (Prompt shows again next time.)

[Enable] when [Remember My Choice] is [ON]: Allows anytime. (Prompt does not show again.)

[Disable] when [Remember My Choice] is [OFF]: Does not allow this consent.

[Disable] when [Remember My Choice] is [ON]: Does not allow anytime. (Prompt does not show again.)

- 4 Enable the Apple CarPlay setting. ➡ P.193
- 5 Apple CarPlay menu screen appears.

You can also perform the above settings by using the touch screen.

To display the prompt: ➡ P.195

To Enable or Disable Apple CarPlay

- 1 Select [Connected Services], and then press the **ENT** switch.

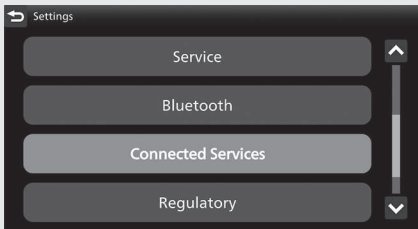

- 2 Select [Apple CarPlay], and then press the **ENT** switch.

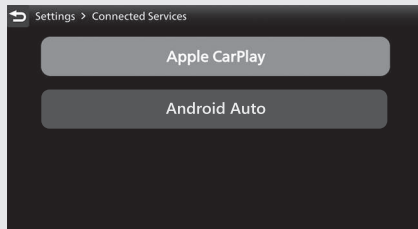

- 3 Select a target device name, and then press the **ENT** switch.

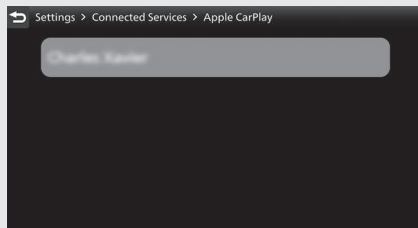

Audio System *(Continued)*

To enable Apple CarPlay:

- 4 Select [Enable Apple CarPlay], and then press the **ENT** switch to [ON] (enable) the function.

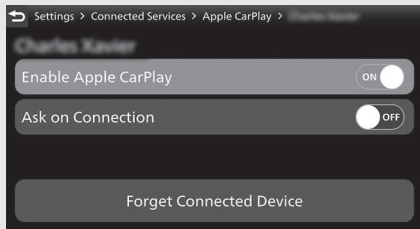

- 5 Return to the riding information, previous screen or Home screen. ➡ P.38

You can also perform the above settings by using the touch screen.

To disable Apple CarPlay:

- 4 Select [Enable Apple CarPlay], and then press the **ENT** switch to [OFF] (disable) the function.

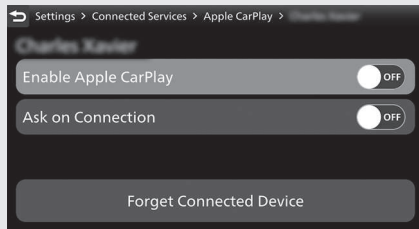

- 5 Return to the riding information, previous screen or Home screen. ➡ P.38

You can also perform the above settings by using the touch screen.

To Select Ask On or Ask Off of the Apple CarPlay disclaimer Screen

- 1 Select [Connected Services], and then press the **ENT** switch.

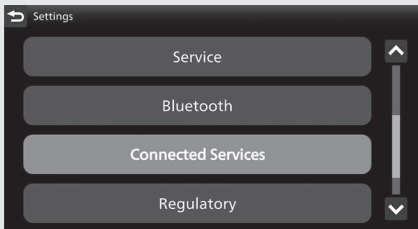

- 2 Select [Apple CarPlay], and then press the **ENT** switch.

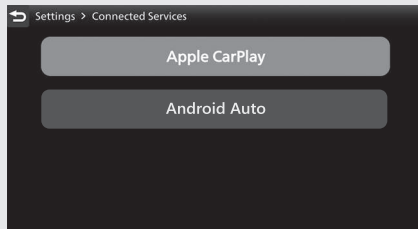

- 3 Select a target device name, and then press the **ENT** switch.

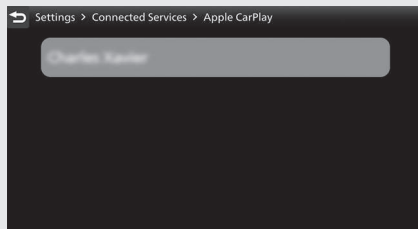

Audio System *(Continued)*

To ask on connection:

- 4 Select [Ask on Connection], and then press the **ENT** switch to [ON] (ask on) the function.

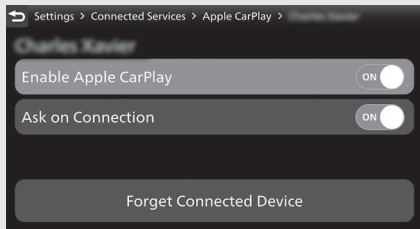

- 5 Return to the riding information, previous screen or Home screen. ➡ **P.38**

You can also perform the above settings by using the touch screen.

To ask off connection:

- 4 Select [Ask on Connection], and then press the **ENT** switch to [OFF] (ask off) the function.

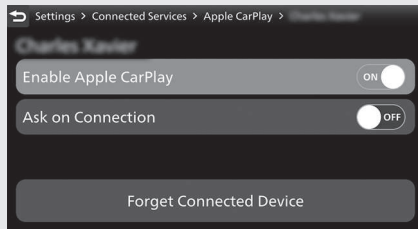

- 5 Return to the riding information, previous screen or Home screen. ➡ **P.38**

You can also perform the above settings by using the touch screen.

| To Connect Your iPhone

- Do not leave your device in the vehicle (under the front seat or under the rear seat etc.). High heat will damage it.
- We recommend backing up your data before playing it.
- iPhone can be charged with the USB cable when the ignition switch is in the ON position. The charging time may be longer than usual.
- We recommend covering your devices with an audio pouch, or soft fabric or cover to protect them from damage.
- Be careful to not get the USB connector wet.
- Do not connect with a hub.
- Do not connect incompatible devices.
- If the audio system does not recognize the iPhone, try reconnecting it a few times or reboot the device.

To connect your iPhone:  **P.236**

| To Disconnect Your iPhone

You can disconnect your iPhone at any time. Make sure to follow the device's instructions on how to disconnect the device from the cable.

Audio System *(Continued)*

Apple CarPlay Menu

Apple CarPlay menu screen



Go back to Home screen

Go back to Apple CarPlay menu screen

Home screen

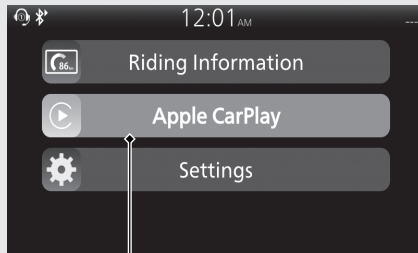

Go to Apple CarPlay menu screen

Phone

Access the contact list, make phone calls, or listen to voice mail.

Music

Play music stored on your iPhone.

Maps

Display Apple CarPlay map and use the navigation function just as you would on your iPhone.

Messages

Check and reply to text messages, or have messages read to you.

Honda

Go back to the Home screen.



Go back to the Apple CarPlay menu screen.

Audio System *(Continued)*

Operating Apple CarPlay with Siri

To activate Siri, pairing with device such as a headset (for rider) must be paired. ➡ P.160

To Activate Siri

- 1 Start Apple CarPlay. ➡ P.191
- 2 Unlock your iPhone and enable Siri.
 - ▶ For details, refer to the iPhone User Guide, etc.
- 3 Push forward the  voice control switch on the left handlebar.

- 4 Say a voice command through the paired headset.

Siri may not be recognized correctly due to the effect of wind noise during running or external noise. In that case, try to change the position of the microphone or to adjust the windscreen height.

➡ P.303

Please visit www.apple.com/ios/siri.

To Deactivate Siri

- 1 Push forward the  voice control switch on the left handlebar.

You can also perform the above settings by using the touch screen.

Siri is a trademark of Apple Inc.

Audio System *(Continued)*

Android Auto™

If you connect an **Android Auto™** compatible **Android™** phone to the system via USB port, you can use the multi-information display, instead of the **Android™** phone display to access the Phone, **Google Maps™** (Navigation), Notification center, and voice search functions.

When you first use **Android Auto™**, you will be required to complete initial setting on your phone screen. We recommend that you complete this initial setting while safely parked before using **Android Auto™**.

- To use **Android Auto™**, you need to download the **Android Auto™** app from **Google Play™** to your smartphone.
- Only **Android™** 5.0 or later versions are compatible with **Android Auto™**. Bluetooth A2DP cannot be used with **Android™** phone.

- Park your vehicle in a safe place before connecting your **Android™** phone to **Android Auto™** and when launching any compatible apps.
- In no event shall Honda be liable for any damages or troubles that occur in the use of **Android™** phone.
- If a mobile network communication is unstable due to surrounding conditions or signal strength conditions, **Android Auto™** functions may not be available.
- To use full functions of **Android Auto™**, a headset connection is necessary.

To connect the paired device:

➡ P.155

- You cannot operate **Android Auto™** by the touch screen while the vehicle is in motion.
- Application and menu items displayed on the screen may differ depending on the connected device and **Android™** version.

- When your **Android™** phone is connected to **Android Auto™**, it is not possible to use the *Bluetooth®* Audio.
- You can connect your **Android™** phone using a certified cable to the USB connector directly. Make sure to use the factory USB cable that came with your device.
- The audio system may not be compatible with the latest model and the latest OS version.
- For details on countries and regions where **Android Auto™** is available, as well as information pertaining to function, refer to the **Android Auto™** homepage.
- **Google™**, **Android™**, **Google Maps™**, **Google Play™** and **Android Auto™** are trademarks of **Google LLC**.

Android Auto™ Operating Requirements & Limitations

Android Auto™ requires a compatible **Android™** phone with an active cellular connection and data plan. Your carrier's rate plans will apply.

Changes in operating systems, hardware, software, and other technology integral to providing **Android Auto™** functionality, as well as new or revised governmental regulations, may result in a decrease or cessation of **Android Auto™** functionality and services.

Honda cannot and does not provide any warranty or guarantee of future **Android Auto™** performance or functionality.

Audio System *(Continued)*

It is possible to use 3rd party apps if they are compatible with **Android Auto™**. Refer to the **Android Auto™** homepage for information on compatible apps.

Use of User and Vehicle Information

The use and handling of user and vehicle information transmitted to /from your phone by **Android Auto™** is governed by the **Google™**'s Privacy Policy.

To Setup Android Auto™

When you connect an **Android™** phone to the unit via the USB port, **Android Auto™** is automatically initiated.

Use of **Android Auto™** will result in the transmission of certain user and vehicle information (such as vehicle location, speed, and status) to your **Android™** phone to enhance the **Android Auto™** experience. You will need to consent to the sharing of this information on the screen.

- 1 Pair the headsets. ➔ P.160
- 2 Connect your Android™ phone to the USB socket. ➔ P. 236
 - ▶ Only initialise Android Auto™ when you safely parked. When Android Auto™ first detects your phone, you will need to set up your phone so that auto pairing is possible.
Refer to the instruction manual that came with your phone.
- 3 When the disclaimer message appears on the screen, select [Enable] and then **ENT** switch.
 - ▶ Set [Remember My Choice] to ON so that you will not be asked the next time you connect.

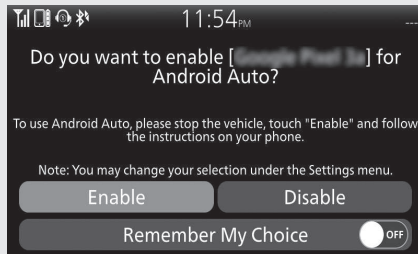

[Enable] when [Remember My Choice] is [OFF]: Allows only once.
(Prompt shows again next time.)

[Enable] when [Remember My Choice] is [ON]: Allows anytime.
(Prompt does not show again.)

[Disable] when [Remember My Choice] is [OFF]: Does not allow this consent.

[Disable] when [Remember My Choice] is [ON]: Does not allow anytime.
(Prompt does not show again.)

Audio System *(Continued)*

- 4 Enable the **Android Auto™** setting ➔ **P.211**
- 5 **Android Auto™** screen appears.
- 6 To appear App launcher screen, select  and then press **ENT** switch.

You can also perform the above settings by using the touch screen.

To display the prompt: ➔ **P.213**

To Enable or Disable Android Auto™

- 1 Select [Connected Services], and then press the **ENT** switch.

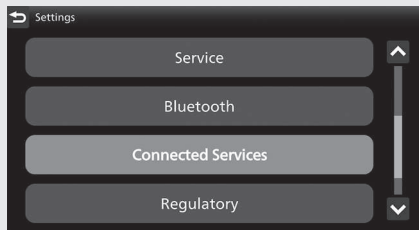

- 2 Select [Android Auto], and then press the **ENT** switch.

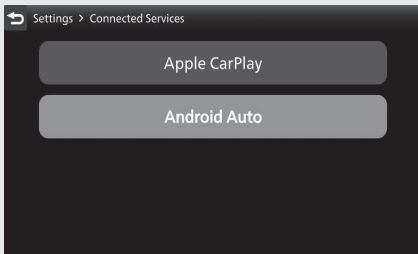

- 3 Select a target device name, and then press the **ENT** switch.

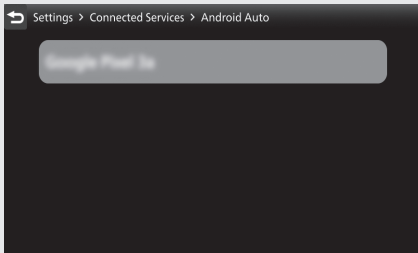

To enable **Android Auto™**:

- 4 Select [Enable], and then press the **ENT** switch to [ON] (enable) the function.

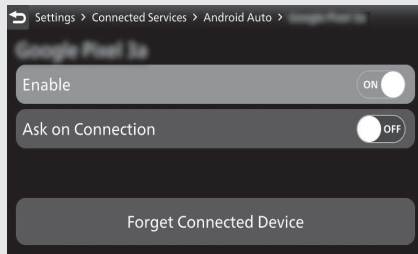

- 5 Return to the riding information, previous screen or Home screen. **➡ P.38**

You can also perform the above settings by using the touch screen.

Audio System *(Continued)*

To disable Android Auto™:

- 4 Select [Enable], and then press the **ENT** switch to [OFF] (disable) the function.

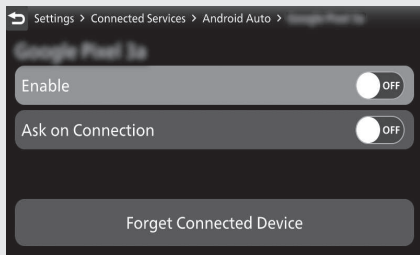

- 5 Return to the riding information, previous screen or Home screen. **➡ P.38**
You can also perform the above settings by using the touch screen.

To Select Ask On or Ask Off of the Android Auto™ disclaimer Screen

- 1 Select [Connected Services], and then press the **ENT** switch.

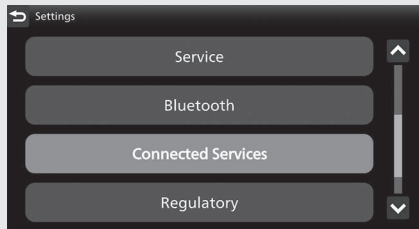

- 2 Select [Android Auto], and then press the **ENT** switch.

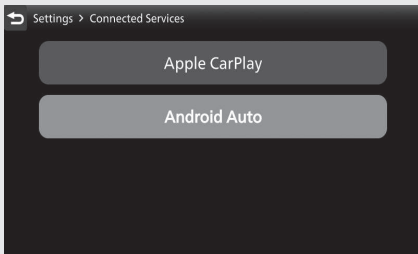

- 3 Select a target device name, and then press the **ENT** switch.

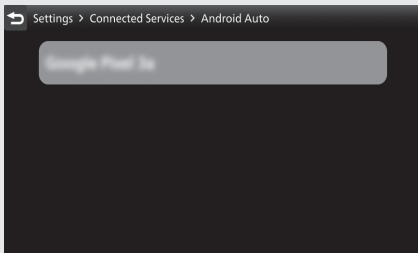

To ask on connection:

- 4 Select [Ask on Connection], and then press the **ENT** switch to [ON] (ask on) the function.

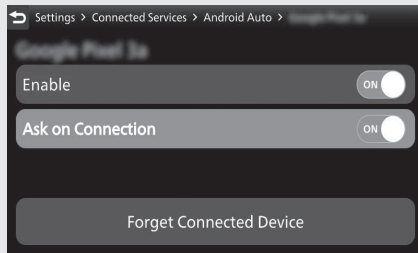

- 5 Return to the riding information, previous screen or Home screen. ➡ **P.38**

You can also perform the above settings by using the touch screen.

To ask off connection:

- 4 Select [Ask on Connection], and then press the **ENT** switch to [OFF] (ask off) the function.

Audio System *(Continued)*

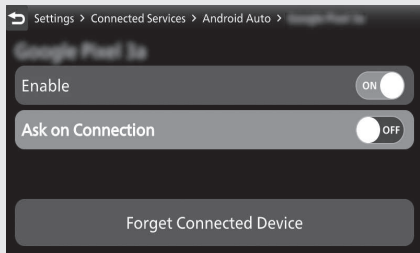

- 5 Return to the riding information, previous screen or Home screen. ➡ P.38

You can also perform the above settings by using the touch screen.

■ To Connect Your Android™ phone

- Do not leave your device in the vehicle (under the front seat or under the rear seat etc.). High heat will damage it.
- We recommend backing up your data before playing it.
- **Android™** phone can be charged with the USB cable when the ignition switch is in the **I** (On) position. The charging time may be longer than usual.
- We recommend covering your devices with an audio pouch, or soft fabric or cover to protect them from damage.
- Be careful to not get the USB connector wet.
- Do not connect with a hub.
- If the audio system does not recognize the **Android™** phone, try reconnecting it a few times or reboot the device.

To connect your Android™ phone:

➡ P.236

■ To Disconnect Your Android™ phone

You can disconnect your **Android™** phone at any time.

Make sure to follow the device's instructions on how to disconnect the device from the cable.

Audio System *(Continued)*

App launcher screen

App launcher screen



Home screen

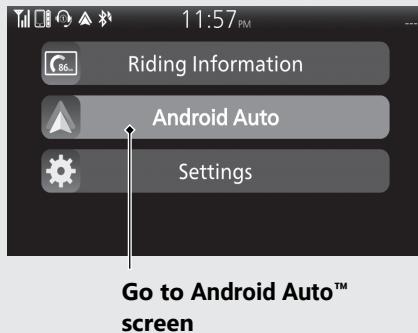

Maps

Display **Google Maps™** and use the navigation function just as you would with your **Android™** phone. When the vehicle is in motion, it is not possible to make keyboard entries. Stop the vehicle in a safe location to undertake a search or provide other inputs.

Phone

Make and receive phone calls as well as listen to voicemail.

 Voice search

Operate Voice search.

 Notification center

See recent calls, messages, and alerts.

Go to App launcher screen

The app launcher opens.

Exit

Go back to the Home Screen.

Audio System *(Continued)*

Operating voice search

To activate the voice search, a device such as a headset must be paired. ➔P.160

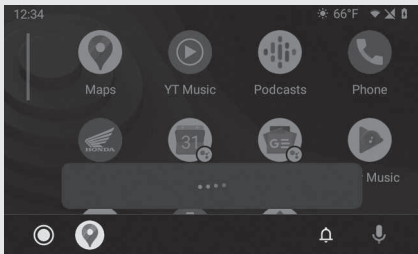

Push forward the  voice control switch on the left handlebar to operate **Android Auto™** with your voice.

You can also activate the voice search by selecting the  icon.

Voice search may not be recognized correctly due to the effect of wind noise during running or external noise. In that case, try to change the position of the microphone or adjust the windscreen height. ➔P.303

Below are examples of commands you can give with voice recognition :

- Reply to text.
- Call my wife.
- Navigate to Honda.
- Play my music.
- Send a text message to my wife.
- Call flower shop.

For more information, please refer to the **Android Auto™** homepage.

Starting the Engine



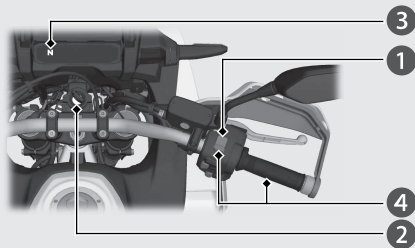

CRF1100A/A4

Start your engine using the following procedure, regardless of whether the engine is cold or warm.



NOTICE



- If the engine does not start within 5 seconds, turn the ignition switch to the OFF position and wait 10 seconds before trying to start the engine again to recover battery voltage.
- Extended fast idling and rewinding the engine can damage the engine and the exhaust system.
- Snapping the throttle or fast idling for more than about 5 minutes may cause exhaust pipe discoloration.

- 1 Make sure the engine stop switch is in the  (Run) position.
- 2 Turn the ignition switch to the ON position.
- 3 Shift the transmission to Neutral ( indicator comes on). Alternatively, pull in the clutch lever to start your vehicle with the transmission in gear so long as the side stand is raised.
- 4 Press the **START**  button with the throttle completely closed.
 - ▶ If you cannot start the engine, open the throttle slightly (about 1/8 in (3 mm), without freeplay) and press the **START**  button.

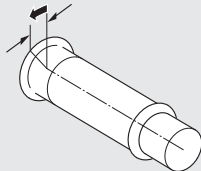
About 1/8 in (3 mm), without freeplay



If the engine does not start:

- ① Open the throttle fully and press the **START**  button for 5 seconds.
 - ▶ The engine will not start at this time.
(When the throttle is fully open, the engine will not start when the **START**  button is pressed.)
Release the throttle and **START**  button after 5 seconds and proceed to step ②.
- ② Repeat the normal starting procedure.
- ③ If the engine starts, open the throttle slightly if idling is unstable.
- ④ If the engine does not start, wait 10 seconds before trying steps ① & ② again.

If Engine Will Not Start  **P.306**

Starting the Engine *(Continued)*

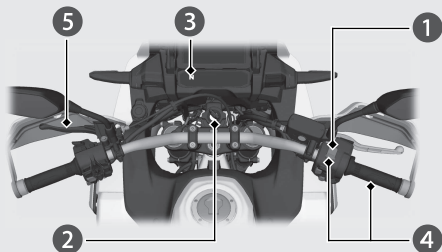

CRF1100D/D4

Start your engine using the following procedure, regardless of whether the engine is cold or warm.



NOTICE

- If the engine does not start within 5 seconds, turn the ignition switch to the OFF position and wait 10 seconds before trying to start the engine again to recover battery voltage.
- Extended fast idling and revving the engine can damage the engine, and the exhaust system.
- Snapping the throttle or fast idling for more than about 5 minutes may cause exhaust pipe discoloration.

- 1 Make sure the engine stop switch is in the  (Run) position.
- 2 Turn the ignition switch to the ON position.
- 3 Check the transmission in Neutral (**N** indicator comes on).
- 4 Press the **START**  button with the throttle completely closed.
 - ▶ If you cannot start the engine, open the throttle slightly (about 1/8 in (3 mm), without freeplay) and press the start **START**  button.

About 1/8 in (3 mm), without freeplay

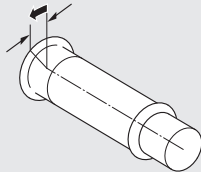

- 5 Make sure the parking brake lever is released before riding. ➡ P.125

| If Engine Does Not Start ➡ P.217

When you stop the engine

- ① To stop the engine, shift the transmission to Neutral (**N** indicator comes on).
 - ▶ If you turn the ignition switch to the OFF position when the vehicle is in gear, the engine will shut off with the clutch disengaged.
- ② Turn the ignition switch to the OFF position.
- ③ Set the parking brake when you park the vehicle. ➡ P.125

Shifting Gears

CRF1100A/A4

Your vehicle transmission has 6 forward gears in a one-down, five-up shift pattern.

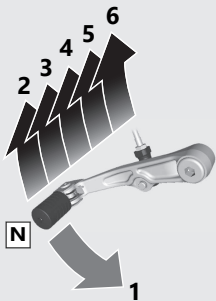

If you put the vehicle in gear with the side stand down, the engine will shut off.

Recommended Shift Points

Shifting Up

From 1st to 2nd	12 mph (20 km/h)
From 2nd to 3rd	19 mph (30 km/h)
From 3rd to 4th	25 mph (40 km/h)
From 4th to 5th	31 mph (50 km/h)
From 5th to 6th	37 mph (60 km/h)

Shifting Down

From 6th to 5th	28 mph (45 km/h)
From 5th to 4th	22 mph (35 km/h)
From 4th to 3rd	16 mph (25 km/h)

NOTICE

Improper shifting can damage the engine, transmission, and drive train. Also, coasting or towing the vehicle for long distances with the engine off can damage the transmission.

CRF1100D/D4

Your vehicle is equipped with an automatically controlled 6-speed transmission. It can be shifted automatically (by AT MODE) or manually (by MT MODE).

Recommended Shift Points**Shifting Up**

From 1st to 2nd	12 mph (20 km/h)
From 2nd to 3rd	19 mph (30 km/h)
From 3rd to 4th	25 mph (40 km/h)
From 4th to 5th	31 mph (50 km/h)
From 5th to 6th	37 mph (60 km/h)

Shifting Down

From 6th to 5th	28 mph (45 km/h)
From 5th to 4th	23 mph (37 km/h)
From 4th to 3rd	20 mph (32 km/h)

NOTICE

Improper shifting can damage the engine, transmission, and drive train. Also, coasting or towing the vehicle for long distances with the engine off can damage the transmission.

Shifting Gears *(Continued)*

Dual Clutch Transmission

CRF1100D/D4

In order to respond to rider demands in a broad range of situations, the transmission is equipped with three operating modes, AT MODE (including D mode for regular operation and three levels of S mode for sporty riding); and MT MODE (MT mode for a 6-speed manual operation), which delivers the same shift feel as a manual transmission.

- ▶ When the vehicle is in gear ("D", "S", or gear position number are displayed), be careful not to open the throttle when pushing or pulling the vehicle back and forth or when turning the handlebar while stationary or at low speeds. If you do so, you may cause the vehicle to unexpectedly and strongly surge forward and lose control.
- ▶ Always use the recommended tires and sprockets to ensure correct Dual Clutch Transmission operation.

The Dual Clutch Transmission system runs a self check immediately after starting the engine.

"—" appears in the gear position indicator window for a few seconds, then goes out. While "—" appears, you cannot shift into gear.

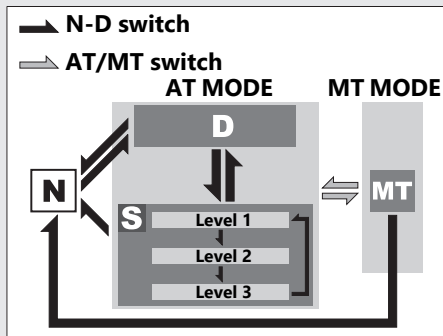

Neutral (N): Neutral is selected automatically when you turn the ignition switch to the ON position.

If neutral is not selected when you turn the ignition switch to the ON position.

- ▶ Turn the ignition switch to the OFF position and then to the ON position again.
- ▶ If neutral is still not selected after turning the ignition switch to the OFF position, and then to the ON position again. **➡ P.311**
You may hear (click) noises when the transmission shifts to Neutral (N). This is normal.

When you can change between N and D

- ▶ Vehicle is stopped and the engine is idling.
- ▶ Throttle is completely closed. It is not possible to change from Neutral to D mode while the throttle is applied.
- ▶ You cannot change between N and D mode while the wheels are rotating.
- ▶ Side stand is raised.

NOTICE

To prevent clutch damage, do not use the throttle to keep the vehicle stopped uphill.

Shifting Gears *(Continued)*

AT MODE: In this mode, the gears are shifted automatically according to your riding conditions.

And also using the shift up switch (+) or shift down switch (-), you can temporarily shift up or down in AT MODE by using the shift switch. These switches are convenient when you want to temporarily down-shift before entering a curve, etc.  **P.227**

You can choose between two modes within AT MODE: D mode and S mode.

D mode (AT): This is the standard mode when AT MODE is selected. Select D mode for regular operation and efficient fuel economy.

S mode (AT): Select this mode while riding in AT MODE when you need more power, such as when overtaking, climbing hills, pulling away.

S mode has three levels of adjustment.

MT MODE (6-speed manual operation): In this mode, you can choose between 6 gears.

Changing between Neutral and AT MODE/MT MODE

Changing from Neutral (N) to AT MODE

Press the **D-S** side of the N-D switch (①).
The D mode indicator comes on and first gear is selected.

Changing from AT or MT MODE to Neutral

Press **N** on the N-D switch (②).

Changing between D mode and S mode while in AT MODE

Press the **D-S** side of the N-D switch. The S or D is shown in the gear position indicator. (③, ④).

Changing between AT MODE and MT MODE

Press the AT/MT switch (⑤).

The AT indicator goes out while MT MODE is selected (⑥).

The gear position is displayed on the gear position indicator while MT MODE is selected (⑥).

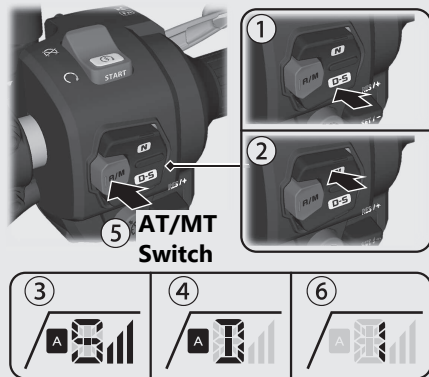



Shifting Gears (Continued)

S mode level selecting while in AT MODE

While in S mode, press and hold the **D-S** side of the N-D (1) switch.

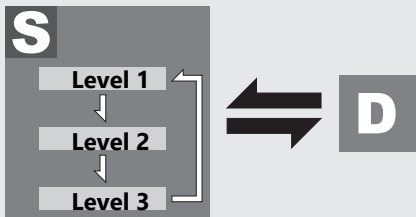
- ▶ Close the throttle completely. Then select the desired level of the S mode.



 Press and hold the **D-S** side of the N-D switch

 Press the **D-S** side of the N-D switch

N-D switch

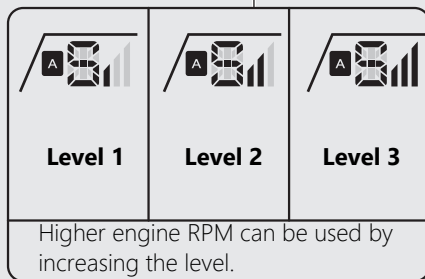
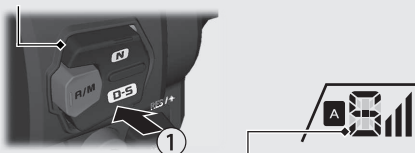

The selected level is maintained even when the ignition switch is turned to the OFF position, or transmission is switched to out of S mode.

Riding in MT MODE

Shift up and down with the shift up switch (+) and shift down switch (-).

The selected gear is shown on the gear position indicator.

- ▶ If the MT MODE is selected, the transmission does not shift up automatically. Do not allow the engine revs to go into the red zone.
- ▶ The transmission automatically shifts down when you slow down, even in MT MODE.
- ▶ You will start from 1st gear even if MT MODE is selected.

Gear shift operation

Shifting Up:

Press the shift up switch (+) (7).

Shifting Down:

Press the shift down switch (-) (8).

You cannot continue shifting gear by keeping the shift switch pressed.

To continue shifting gear release the switch and press it again.

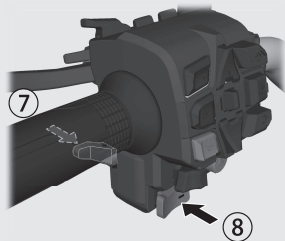

Shift Limit

You cannot downshift if the engine will exceed the rev limit.

Cruise Control

The cruise control system allows you to maintain a steady speed within a specified range.

The available speed setting range and operating gear are listed below:

CRF1100A/A4

Available Speed setting range	30 - 100 mph (50 – 160 km/h)
Operating gear	From 4th to 6th gear

CRF1100D/D4

Available Speed setting range	30 - 100 mph (50 – 160 km/h)
Operating gear	From 3rd to 6th gear

When cruise control is on, your speed will still vary slightly, particularly going up and down hills.



Cruise control is intended for use only on straight, uncongested highways. Do not use cruise control on city streets, winding roads, during bad weather, or at any other time when you need total control of the throttle.

WARNING

Improper use of the cruise control can lead to a crash in which you could be seriously hurt or killed.

Use the cruise control only when travelling on open highways in good weather.

To Set Cruise Control

- 1 Make sure the travelling speed and operating gear are conformed to the requirements of the system.
Any speed other than the available range will not be memorized.
- 2 Press the  cruise control main switch. (The  cruise control main indicator will come on.)
- 3 Accelerate to the desired speed.
- 4 Push the **RES / +** **SET / -** cruise control lever to **SET / -** side. (The cruise control **SET** indicator will come on.) Your current travelling speed is memorized.

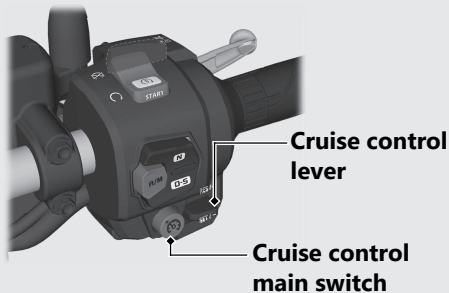
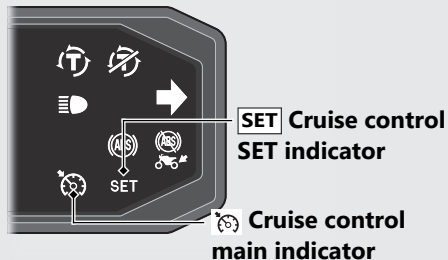

Cruise Control *(Continued)*

To Change the Set Speed

To Fine Tune the Set Speed

- 1 Select the riding information. P.38
- 2 To increase the set speed: tap the **RES / +** **SET / -** cruise control lever to **RES / +** side.
To decrease the set speed: tap the **RES / +** **SET / -** cruise control lever to **SET / -** side.
- 3 The set speed is displayed in the multi-information display.



Cruise control set speed

Each quick tap (brief push and release) on either side will change your speed by 1 mph

or 1 km/h (depending on mileage meter set unit).

Any speed other than the possible setting range will not be indicated (stops at the upper or lower limit speed).

To Change the Set Speed Continuously

- To increase the set speed: push and hold the **RES / +** **SET / -** cruise control lever to **RES / +** side.
The system will accelerate your vehicle automatically. When you reach the desired speed, release the **RES / +** **SET / -** cruise control lever.
If the **RES / +** **SET / -** cruise control lever is pushed and held to **RES / +** side continuously, the set speed indicated in the multi-information display stops at the upper limit of the possible setting range.

- To decrease speed: push and hold the **RES / +** **SET / -** cruise control lever to **SET / -** side. The system will automatically slow your vehicle. When you reach the desired speed, release the **RES / +** **SET / -** cruise control lever. If the **RES / +** **SET / -** cruise control lever is pushed and held to **SET / -** side continuously, the set speed indicated in the multi-information display stops at the lower limit of the possible setting range.

To Manually Increase the Set Speed

- 1 Use the throttle to accelerate until you reach the desired speed.
- 2 Push and release the **RES / +** **SET / -** cruise control lever to **SET / -** side.

To Manually Increase Vehicle Speed

- 1 Use the throttle in the normal manner to accelerate.
- 2 To return to the set speed, close the throttle and coast without applying the brakes. The cruise system will maintain the speed you previously set.

To Cancel Cruise Control

To Disengage the System

- Press the cruise control main switch. (The  cruise control main indicator goes off and the set speed will be erased from memory.)

Cruise Control *(Continued)*

To Temporarily Disengage the System

- 1 Perform one of the following operations to disengage the system temporarily. (SET Cruise control SET indicator temporarily goes off but the set speed remains in memory.)
 - Apply the brake lever or pedal.
 - Rotate the throttle grip past the automatically closed position in the deceleration direction.
 - **CRF1100A/A4**
Disengage the clutch or operate the shift pedal.

- 2 To resume cruise control:
 - If you are still over 30 mph (50 km/h), push and release the RES / + SET / - cruise control lever to RES / + side.
 - If you are under 30 mph (50 km/h), use the throttle to increase road speed above 30 mph (50 km/h) and then push and release the RES / + SET / - cruise control lever to RES / + side.

Cornering Light

CRF1100A4/D4

The cornering light lights up the direction of travel of the vehicle when cornering.

Operating conditions:

- Vehicle has been ridden at a speed of over 6 mph (10 km/h).
- When the vehicle banking left or right.

Three-step lighting state is switched by the bank angle.

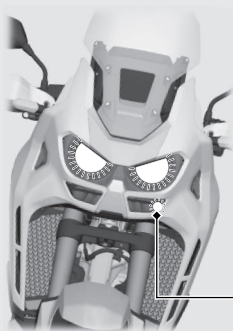

Cornering light



Refueling

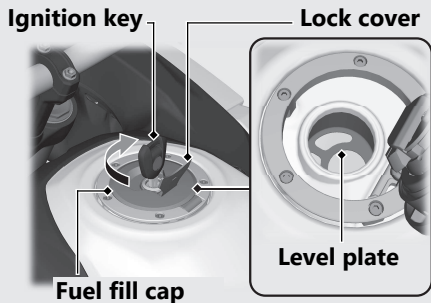

Do not fill with fuel above the level plate.

Fuel type: Unleaded gasoline only

Recommended fuel octane number:
Pump Octane Number (PON) 86 or higher.

Tank capacity:

CRF1100A/D 4.97 US gal (18.8 L)

CRF1100A4/D4 6.55 US gal (24.8 L)

Refueling and Fuel Guidelines ➔ P.13

Opening the Fuel Fill Cap

Open the lock cover, insert the ignition key, and turn it clockwise to open the fuel fill cap.

Closing the Fuel Fill Cap

- 1 After refueling, push the fuel fill cap closed until it locks.
- 2 Remove the key and close the lock cover.
 - ▶ The key cannot be removed if the fuel fill cap is not locked.

⚠WARNING

Gasoline is highly flammable and explosive. You can be burned or seriously injured when handling fuel.

- Stop the engine, and keep heat, sparks, and flames away.
- Only handle fuel outdoors.
- Wipe up spills immediately.

Accessory Socket

CRF1100A4/D4

The accessory socket is located in the left side inner panel cover.

Use accessory devices at your own risk. In no event shall Honda be liable for any damages to your accessory device when in use.

Open the cover to access the socket.

Rated capacity is

24 W (12 V, 2 A).

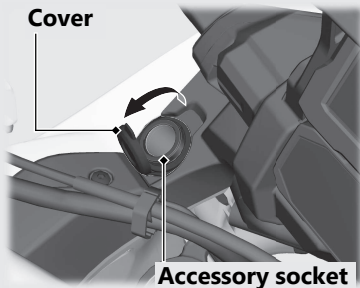

- ▶ To prevent the battery from becoming weak (or dead), keep the engine running while drawing current from the socket.
- ▶ To prevent entry of foreign matter into the socket, be sure to close the cover when the socket is not used.
- ▶ Carefully secure all connected devices, as vibration may cause damage to them or they could shift unexpectedly.

NOTICE

- Using any heat-generating accessory or improperly rated accessory can damage the socket.
- Do not use the socket in wet conditions, when or while washing or any other wet conditions as these will damage the socket.
- Do not allow the accessory's harness to become pinched or trapped.
- Do not allow the accessory's harness to interfere with the steering or controls.

USB Socket

The USB socket is located in the right side front turn signal light cover (CRF1100A/D) or right side inner panel cover (CRF1100A4/D4). Use USB devices at your own risk. In no event shall Honda be liable for any damage to your USB device when in use.

Only USB devices within the following USB Type-A connectors can be used.
Open the cover to access the socket.

Rated capacity is

7.5 W (5 V, 1.5 A).

To connect your USB device

- 1 Open the cover to access the USB socket.

USB socket

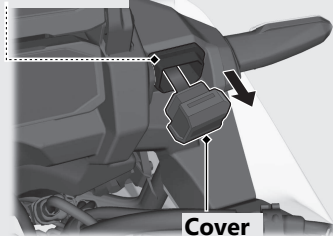

- 2 Connect a certified USB cable to the socket.
- 3 Route the USB cable along the recess.
- 4 Pass the USB cable through the cover slit and close the cover.

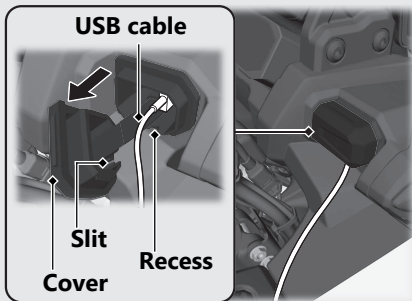

- ▶ To prevent the battery from becoming weak (or dead), keep the engine running while drawing current from the socket.
- ▶ To prevent entry of foreign matter into the socket, be sure to close the cover.
- ▶ Carefully secure all connected devices, as vibration may cause damage to them or they could shift unexpectedly.

NOTICE

- Using any heat-generating USB devices or improperly rated USB devices can damage the socket.
- Do not use the USB socket in wet conditions, when or while washing or any other wet conditions as these will damage the USB socket.
- Do not allow the USB cable to become pinched or trapped.
- Do not allow the USB cable to interfere with the steering or controls.

Storage Equipment

Helmet holder

A helmet holder is located under the rear seat.

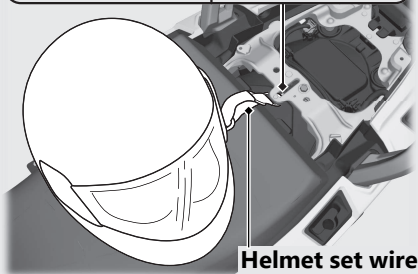
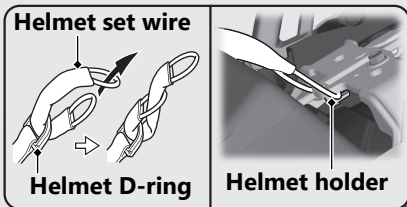

► Use the helmet holder only when parked.

Removing the rear seat ➔ P.271

⚠ WARNING

Riding with a helmet attached to the holder can interfere with your ability to safely operate the vehicle and could lead to a crash in which you can be seriously hurt or killed.

Use the helmet holder only while parked. Do not ride with a helmet secured by the holder.

Helmet Set Wire

The helmet set wire is secured on the rear fender under the rear seat.

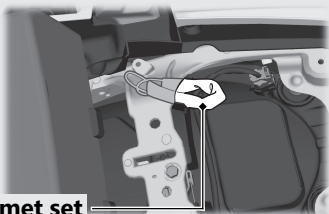

Helmet set wire

Removing the rear seat ➔ P.271

Document Bag

The document bag is located on the underside of the front seat.



Document bag

Removing the front seat ➔ P.268

Storage Equipment *(Continued)*

Fuse Puller, Hex Wrench, Standard/Phillips Screwdriver, Screwdriver Handle

The fuse puller, hex wrench, standard/phillips screwdriver and screwdriver handle are located on the underside of the rear seat.

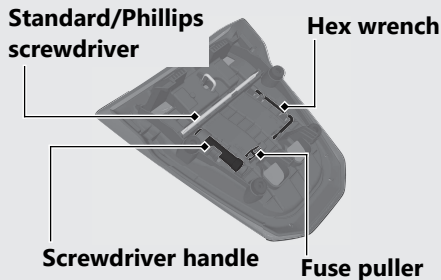

Removing the rear seat → P.271

Tool Kit

Canada

The tool kit is located in the tool box.

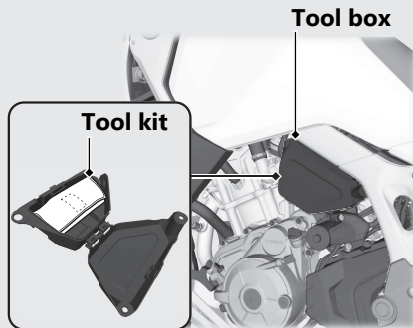

Removing the tool box → P.272

Rear Carrier

Never exceed the maximum weight limit.

Maximum Weight: 22 lb (10 kg)

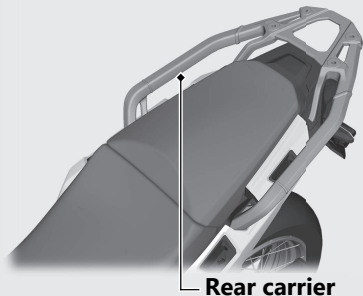

Rear carrier

Maintenance

Please read "Importance of Maintenance" and "Maintenance Fundamentals" carefully before attempting any maintenance. Refer to "Specifications" for service data.

Importance of Maintenance	P. 243	Engine Oil	P. 275
Maintenance Schedule	P. 245	Coolant	P. 277
Maintenance Record	P. 248	Brakes	P. 279
Maintenance Fundamentals	P. 249	Side Stand	P. 283
Tools	P. 264	Drive Chain	P. 284
Removing & Installing Body		Wheels	P. 286
Components	P. 265	Clutch	P. 288
Battery	P. 265	Throttle	P. 291
Battery Box Cover	P. 266	Other Adjustments	P. 292
Clip	P. 267	Adjusting the Brake Lever	P. 292
Front Seat	P. 268	Adjusting the Front Suspension	P. 293
Rear Seat	P. 271	Adjusting the Rear Suspension	P. 297
Tool Box	P. 272	Adjusting the Windscreen Height	P. 303
Spark Arrester	P. 273		

Importance of Maintenance

Importance of Maintenance

Keeping your vehicle well-maintained is absolutely essential to your safety and to protect your investment, obtain maximum performance, avoid breakdowns, and reduce air pollution. Maintenance is the owner's responsibility. Be sure to inspect your vehicle before each ride and perform the periodic checks specified in the Maintenance Schedule. ➤ P. 245

⚠ WARNING

Improperly maintaining your vehicle or failing to correct a problem before you ride can cause a crash in which you can be seriously hurt or killed.

Always follow the inspection and maintenance recommendations and schedules in this owner's manual.

For information about the exhaust emission and noise emission requirements of the U.S. Environmental Protection Agency (EPA), the California Air Resources Board (CARB), and the Environment and Climate Change Canada (ECCC). ➤ P. 350

USA

Maintenance, replacement or repair of the emission control devices and systems may be performed by any vehicle repair establishment or individual using parts that are "certified" to EPA standards.

Maintenance Safety

Always read the maintenance instructions before you begin each task and make sure that you have the tools, parts, and skills required.

We cannot warn you of every conceivable hazard that can arise in performing maintenance. Only you can decide whether or not you should perform a given task.

Follow these guidelines when performing maintenance.

- Stop the engine and remove the key.
- Place your vehicle on a firm, level surface using the side stand or a maintenance stand to provide support.
- Allow the engine, muffler, brakes, and other high-temperature parts to cool before servicing as you can get burned.
- Run the engine only when instructed, and do so in a well-ventilated area.

Maintenance Schedule

The maintenance schedule specifies the maintenance requirements necessary to ensure safe, dependable performance, and proper emission control.

Maintenance work should be performed in accordance with Honda's standards and specifications by properly trained and equipped technicians. Your dealer meets all of these requirements. All scheduled maintenance is considered a normal owner operating cost and will be charged to you by your dealer. Keeping an accurate maintenance record will help ensure your vehicle is properly maintained.

➤ P. 248

Make sure whoever performs the scheduled maintenance completes the maintenance record. Retain all service documents. If you sell your vehicle, these service documents should be transferred with the vehicle to the new owner.

Maintenance Schedule

Items	Frequency*1								Regular Replace	Refer to page	
	× 1,000 mi	0.6	4	8	12	16	20	24			
	× 1,000 km	1.0	6.4	12.8	19.2	25.6	32.0	38.4			
Honda Diagnostic System		I	I	I	I	I	I	I		–	
Fuel Line				I		I		I		–	
Throttle Operation				I		I		I		291	
Air Cleaner*2					R			R		–	
Crankcase Breather*3			C	C	C	C	C	C		–	
Spark Plug		Every 16,000 mi (25,600 km): I Every 32,000 mi (51,200 km): R									–
Valve Clearance						I				–	
Engine Oil		R		R		R		R	1 Year	–	
Engine Oil Filter		R				R				–	
Clutch Oil Filter*8		R				R				–	
Engine Idle Speed				I		I		I		–	
Radiator Coolant*5				I		I		I	3 Years	277	
Cooling System				I		I		I		–	
Secondary Air Supply System						I				–	
Evaporative Emission Control System*4						I				–	

Maintenance Level









































































- : Intermediate. We recommend service by your dealer, unless you have the necessary tools and are mechanically skilled.
Procedures are provided in an official Honda Service Manual (P. 356).
- : Technical. In the interest of safety, have your vehicle serviced by your dealer.

Emission-Related Maintenance

: Emission-Related Items

Maintenance Legend

- I** : Inspect (clean, adjust, lubricate, or replace, if necessary)
R : Replace
L : Lubricate
C : Clean

Items	Frequency*1								Regular Replace	Refer to page
	× 1,000 mi	0.6	4	8	12	16	20	24		
	× 1,000 km	1.0	6.4	12.8	19.2	25.6	32.0	38.4		
Drive Chain*7			Every 600 mi (1,000 km):   							284
Drive Chain Slider										285
Brake Fluid*5									2 Years	279
Brake Pads Wear										280
Brake System										249
Brake Light Switch										282
Brake Lock Operation*8										281
Headlight Aim										–
Clutch System*9										288
Side Stand										283
Suspension										–
Spark Arrester*6										273
Nuts, Bolts, Fasteners*7										–
Wheels/Tires*7										259, 286
Steering Head Bearings										–

Notes:

- *1: At higher odometer reading, repeat at the frequency interval established here.
 *2: Service more frequently when riding in unusually wet or dusty areas.
 *3: Service more frequently when riding in rain or at full throttle.

*4: 50 STATE (meets California).

*5: Replacement requires mechanical skill.

*6: USA only.

*7: Service more frequently when riding OFF-ROAD.

*8: CRF1100D/D4 only

*9: CRF1100A/A4 only

Maintenance Record

Distance	Odometer	Date	Performed By:	Notes
600 miles (1,000 km)				
4,000 miles (6,400 km)				
8,000 miles (12,800 km)				
12,000 miles (19,200 km)				
16,000 miles (25,600 km)				
20,000 miles (32,000 km)				
24,000 miles (38,400 km)				
28,000 miles (44,800 km)				
32,000 miles (51,200 km)				
36,000 miles (57,600 km)				
40,000 miles (64,000 km)				
44,000 miles (70,400 km)				
48,000 miles (76,800 km)				
52,000 miles (83,200 km)				
56,000 miles (89,600 km)				
60,000 miles (96,000 km)				
64,000 miles (102,400 km)				
68,000 miles (108,800 km)				

Pre-ride Inspection

To ensure safety, it is your responsibility to perform a pre-ride inspection and make sure that any problem you find is corrected. A pre-ride inspection is a must, not only for safety, but because having a breakdown, or even a flat tire, can be a major inconvenience.

Before riding on-road, or returning to pavement after riding off-road, take a few moments to walk around your vehicle and look for any loose parts or anything that appears unusual.

Also check the following.

- Tire tread wear and air pressures are within limits ➤ P. 259
- Lights, horn, and turn signals operate normally
- Check the condition of the drive chain. Adjust slack and lubricate as needed ➤ P. 257

Check the following items if you are carrying a passenger or cargo:

- Combined weight is within load limits ➤ P. 369
- Cargo is secured properly
- Suspension is adjusted to suit load ➤ P. 293 ➤ P. 297

Check the following items after you get on your vehicle:

- Throttle action moves smoothly without binding ➤ P. 291
- Brake lever and pedal operate normally
- Check the fuel level and refuel when needed ➤ P. 13, ➤ P. 234
- Engine stop switch functions properly ➤ P. 112

Maintenance Fundamentals

Check the following items at regular intervals:

- Oil level is between the upper and lower level marks ➤ P. 275

- Brake fluid level:

Front: above the LOWER level mark ➤ P. 279

Rear: between the UPPER and LOWER level marks ➤ P. 279

- Engine coolant level is between the UPPER and LOWER level marks ➤ P. 277

- Side stand functions properly ➤ P. 283

- **CRF1100D/D4**

Parking brake works properly ➤ P. 281

Before riding off-road check all of the preceding plus the following:

- Make sure spokes are tight. Check the rims for any damage ➤ P. 286

- Oil level is between the upper and lower marks ➤ P. 275

- Check the fuel level and refuel when needed ➤ P. 13, ➤ P. 234

- Be sure the fuel fill cap is securely fastened ➤ P. 234

- **CRF1100A/A4**

Clutch lever operates smoothly. Adjust freeplay if necessary ➤ P. 288

- Check for loose cables and other parts, and anything that appears abnormal

- Use a wrench to check the tightness of all accessible nuts, bolts and fasteners

Periodic Checks

You should also perform other periodic maintenance checks at least once a month

regardless of how often you ride, or more often if you ride frequently.

Also, check the odometer reading against the Maintenance Schedule and perform all maintenance that is due. ➔ P. 245

Tires and wheels	Check the air pressure (➔ P. 259), examine tread for wear and damage (➔ P. 260), and check the wheels for damage.
Fluid levels	Check the engine oil level (➔ P. 275), engine coolant level (➔ P. 277), and brake fluid level (➔ P. 279).
Lights	Check that the headlight, cornering light (CRF1100A4/D4 only), brake light, taillight, license plate light, and turn signals are working properly.
Controls	Check the freeplay of the clutch lever (CRF1100A/A4 only) (➔ P. 288), throttle grip (➔ P. 291), front brake lever (➔ P. 292), rear brake pedal and parking brake (CRF1100D/D4 only) (➔ P. 281) operate properly.
Drive chain	Check the slack (➔ P. 284), adjust the slack, and lubricate (➔ P. 258) as needed.
Fuses	Check that you have a full supply of spare fuses.
Nuts & bolts	Check the major nuts and bolts, and tighten as needed.
Crankcase breather	Service the crankcase breather more frequently if your vehicle is ridden in the rain or often at full throttle. Service the breather if you can see deposits in the transparent section of the drain tube.

Replacing Parts

Always use Honda Genuine Parts or their equivalents to ensure reliability and safety. When ordering colored components, specify the model name, color, and code mentioned on the color label.

The color label is attached to the rear fender under the rear seat. ➤ P. 271

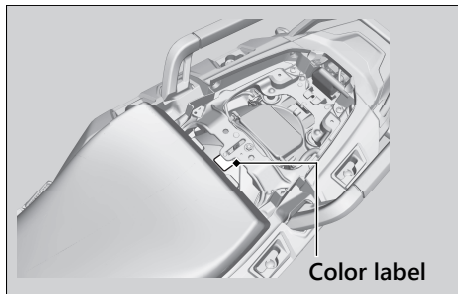

⚠ WARNING

Installing non-Honda parts may make your vehicle unsafe and cause a crash in which you can be seriously hurt or killed.

Always use Honda Genuine Parts or equivalents that have been designed and approved for your vehicle.

Lithium-Ion (Li-Ion) Battery

Your vehicle has a lithium-ion (li-ion) battery. Clean the battery terminals if they become dirty or corroded.



This symbol on the battery means that this product must not be treated as household waste.

NOTICE

An improperly disposed of battery can be harmful to the environment and human health. Always confirm local regulations for proper battery disposal instruction.

What to do in an emergency

If any of the following occurs, immediately see your doctor.

- Electrolyte splashes into your eyes:
 - ▶ Wash your eyes repeatedly with cool water for at 15 minutes. Using water under pressure can damage your eyes.
- Electrolyte splashes onto your skin:
 - ▶ Remove affected clothing and wash your skin thoroughly using water.

- Electrolyte splashes into your mouth
 - ▶ Rinse mouth thoroughly with water, and do not swallow.

⚠ WARNING

The battery contains flammable organic solvent as electrolyte.

You can be burned or seriously injured if the battery is handled improperly.

- Keep the battery away from heat, sparks, and flames.
- Keep the battery out of the reach of children.
- Do not disassemble or modify the battery or battery terminals.
- Do not short-circuit the battery with metal tools or other metal objects.
- Do not subject the battery to impacts.

Cleaning the Battery Terminals

1. Remove the battery. ➤ P. 265
2. If the terminals are starting to corrode and are coated with a white substance, wash with warm water and wipe clean.
3. If the terminals are heavily corroded, clean and polish the terminals with a wire brush or sandpaper. Wear safety glasses.

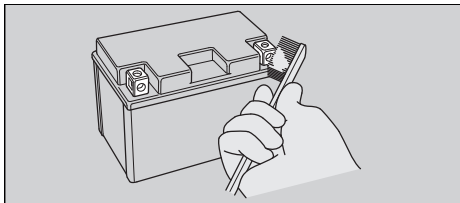

4. After cleaning, reinstall the battery. The battery has a limited life span. Consult your dealer about when you should replace the battery. Always replace the battery with another lithium-ion (li-ion) battery of the same type.

Charging

If you use electrical accessories that drain the battery or you do not ride frequently, we recommend that you charge the battery every 30 days using a charger recommended by your lithium-ion (li-ion) battery manufacturer. Contact your dealer before charging the battery.

Make sure the ignition switch is in the OFF position before charging the battery.

NOTICE

Only use a charger recommended by your lithium-ion (li-ion) battery manufacturer. Using a battery charger that is not recommended can cause permanent damage to your battery.

NOTICE

Improper charging can damage the battery. If you can't charge the battery or it appears unable to hold a charge, contact your dealer.

NOTICE

Do not jump-start, as this can damage your vehicle's electrical system and battery. Bump starting is not recommended.

NOTICE

Installing non-Honda electrical accessories can overload the electrical system, discharging the battery and possibly damaging the system.

Fuses

Fuses protect the electrical circuits on your vehicle. If something electrical on your vehicle stops working, check for and replace any blown fuses. ➤ P. 331

Inspecting and Replacing Fuses

Turn the ignition switch to the OFF position to remove and inspect fuses. If a fuse is blown, replace with a fuse of the same rating. For fuse ratings, see "Specifications." ➤ P. 372

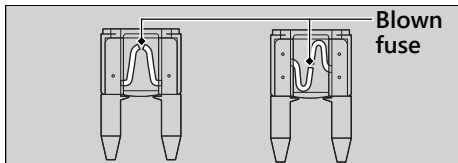
**NOTICE**

Replacing a fuse with one that has a higher rating greatly increases the chance of damage to the electrical system.

If a fuse fails repeatedly, you likely have an electrical fault. Have your vehicle inspected by your dealer.

Engine Oil

Engine oil consumption varies and oil quality deteriorates according to riding conditions and time elapsed.

Check the engine oil level regularly, and add the recommended engine oil if necessary. Dirty oil or old oil should be changed as soon as possible.

Selecting the Engine Oil

For recommended engine oil, see "Specifications." ▣ P. 371

If you use non-Honda engine oil, check the label to make sure that the oil satisfies all of the following standards:

- JASO T 903 standard*¹: MA
- SAE standard*²: 10W-30
- API classification*³: SJ or higher

*¹. The JASO T 903 standard is an index for engine oils for 4-stroke motorcycle engines. There are two classes: MA and MB. For example, the following label shows the MA classification.

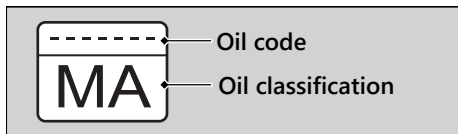

- *². The SAE standard grades oils by their viscosity.
- *³. The API classification specifies the quality and performance rating of engine oils. Use SJ or higher oils, excluding oils marked as "Energy Conserving" or "Resource Conserving" on the circular API service symbol.

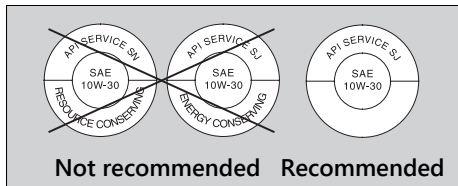

Brake Fluid

Do not add or replace brake fluid, except in an emergency. Use only fresh brake fluid from a sealed container. If you do add fluid, have the brake system serviced by your dealer as soon as possible.

NOTICE

Brake fluid can damage plastic and painted surfaces.
Wipe up spills immediately and wash thoroughly.

Recommended brake fluid:

Honda DOT 4 Brake Fluid or equivalent

⚠WARNING

Clean filler cap before removing. Use only DOT 4 fluid from a sealed container.

Drive Chain

The drive chain must be inspected and lubricated regularly. Inspect the chain more frequently if you often ride on bad roads, ride at high speed, or ride with repeated fast acceleration. ➤ P. 284

If the chain does not move smoothly, makes strange noises, has damaged rollers, has loose pins, has missing O-rings, or has kinks, have the chain inspected by your dealer.

Also inspect the drive sprocket and driven sprocket. If either has worn or damaged teeth, have the sprocket replaced by your dealer.



Normal
(GOOD)



Worn
(REPLACE)



Damaged
(REPLACE)

NOTICE

Use of a new chain with worn sprockets will cause rapid chain wear.

Cleaning and Lubricating

After inspecting the slack, clean the chain and sprockets while rotating the rear wheel. Use a dry cloth with chain cleaner designed specifically for O-ring chains, or neutral detergent. Use a soft brush if the chain is dirty.

After cleaning, wipe dry and lubricate with the recommended lubricant.

Recommended lubricant:

Pro Honda HP Chain Lube or equivalent

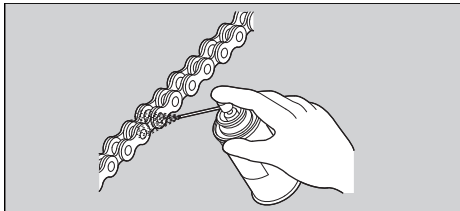

Do not use a steam cleaner, a high pressure cleaner, a wire brush, volatile solvent such as gasoline and benzene, abrasive cleaner, chain cleaner or lubricant NOT designed specifically for O-ring chains as these can damage the rubber O-ring seals.

Avoid getting lubricant on the brakes or tires. Avoid applying excess chain lubricant to prevent spray onto your clothes and the vehicle.

Recommended Coolant

Pro Honda HP Coolant is a pre-mixed solution of antifreeze and distilled water.

Concentration:

50% antifreeze and 50% distilled water

A concentration of antifreeze below 40% will not provide proper corrosion and cold temperature protection.

A concentration of up to 60% will provide better protection in colder climates.

NOTICE

Using coolant not specified for aluminum engines or tap/mineral water can cause corrosion.

Crankcase Breathers

Service more frequently when riding in rain, at full throttle, or after the vehicle is washed or overturned. Service if the deposit level can be seen in the transparent section of the drain tube.

If the drain tube overflows, the air filter may become contaminated with engine oil, causing poor engine performance.

Tires (Inspecting/Replacing)

Checking the Air Pressure

Visually inspect your tires and use an air pressure gauge to measure the air pressure before each off-road ride and whenever you return to pavement after riding off-road. If you only ride on pavement, check the pressure at least once a month or any time you think the tires look low. Always check air pressure when your tires are cold.

Maintenance Fundamentals

If you decide to adjust the tire pressure for a particular off-road riding condition, make changes a little at a time.

Even if the direction of the valve stem is changed, do not return it to the original position. Have your vehicle inspected by your dealer.

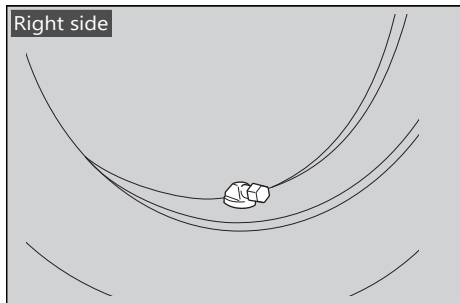

Inspecting for Damage

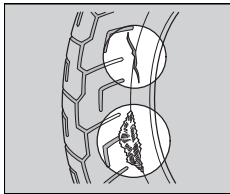

Inspect the tires for cuts, slits, or cracks that expose fabric or cords, or nails or other foreign objects embedded in the side of the tire or the tread.

Also inspect for any unusual bumps or bulges in the side walls of the tires.

Inspecting for Abnormal Wear

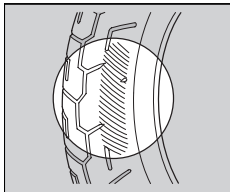

Inspect the tires for signs of abnormal wear on the contact surface.

Inspecting Tread Depth

Inspect the tread wear indicators. If they become visible, replace the tires immediately. For safe riding, you should replace the tires when the minimum tread depth is reached.

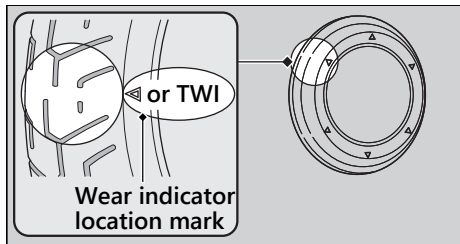

⚠️ WARNING

Riding on tires that are excessively worn or improperly inflated can cause a crash in which you can be seriously hurt or killed.

Follow all instructions in this owner's manual regarding tire inflation and maintenance.

Maintenance Fundamentals

Have your tires replaced by your dealer. For recommended tires, air pressure, and minimum tread depth, see "Specifications."

➤ P. 370

Follow these guidelines whenever you replace tires:

- Use the recommended tires or their equivalents of the same size, construction, speed rating, and load range.
- Have the wheel balanced with Honda Genuine balance weights or equivalent after the tire is installed.
- Do not install a tube inside a tubeless tire on this vehicle. Excessive heat build-up can cause the tube to burst.
- Use only tubeless tires on this vehicle. The rims are designed for tubeless tires, and during hard acceleration or braking, a tube-type tire could slip on the rim and cause the tire to rapidly deflate.

WARNING

Installing improper tires on your vehicle can adversely affect handling and stability, and can cause a crash in which you can be seriously hurt or killed.

Always use the size and type of tires recommended in this owner's manual.

Tire Service Life

The service life of your tires is dependent on many factors, including, but not limited to, riding habits, road conditions, vehicle loading, tire air pressure, maintenance history, speed, and environmental conditions (even when the tires are not in use).

In addition to your regular inspections and maintenance, it is recommended that you have annual inspections performed once the tires reach 5 years old. It is also recommended that all tires be removed from service after 10 years from the date of manufacture, regardless of their condition or state of wear.

The last four digits of the TIN (tire identification number) indicate the date of manufacture.

Tire Identification Number (TIN)

The tire identification number (TIN) is a group of numbers and letters located on the sidewall of the tire.

① ② ③

DOT XXXX XXXX 20 23

DOT: This indicates that the tire meets all requirements of the U.S. Department of Transportation.

- ① XXXX: Factory code
- ② XXXX: Tire type code
- ③ 20 23: Date of manufacture (week & year). Example: week 20 in year 23.

Tire Labeling Example

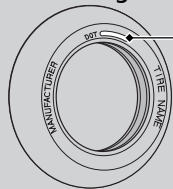

Tire identification number (TIN)

You can perform some roadside repairs, minor adjustments and parts replacement with the provided tools.

Canada

The tool kit is stored in the tool box. ➔ P. 240

- Spark plug wrench
- 10 × 14 mm Open end wrench
- 14 × 17 mm Open end wrench
- 19 mm Box end wrench

The helmet set wire is secured with the rear fender under the rear seat. ➔ P. 239

- Helmet set wire

The 5 mm hex wrench, standard/phillips screwdriver, screwdriver handle and fuse puller are located on the underside of the rear seat.

➔ P. 240

- 5 mm Hex wrench
- Standard/Phillips screwdriver
- Screwdriver handle
- Fuse puller

Battery

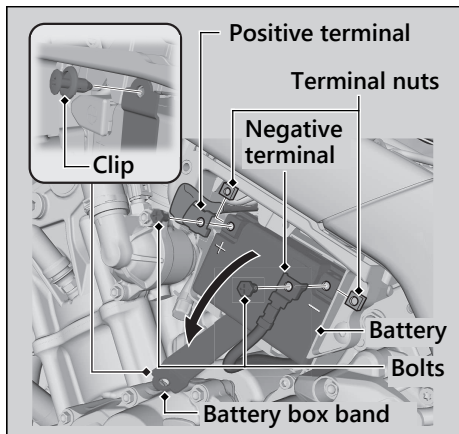

Removal

Make sure the ignition switch is in the OFF position.

1. Remove the tool box. ➤ P. 272
2. Disconnect the negative \ominus terminal from the battery.
3. Disconnect the positive \oplus terminal from the battery.
4. Remove the clip. ➤ P. 267
5. Open the battery box band.
6. Remove the battery from the battery case taking care not to drop the terminal nuts.

Installation

Install the parts in the reverse order of removal. Always connect the positive \oplus terminal first.

Make sure that bolts and nuts are tight. Make sure the clock information is correct after the battery is reconnected. ➤ P. 87

For proper handling of the battery, see "Maintenance Fundamentals." ➤ P. 253
"Battery Goes Dead." ➤ P. 330

Battery Box Cover

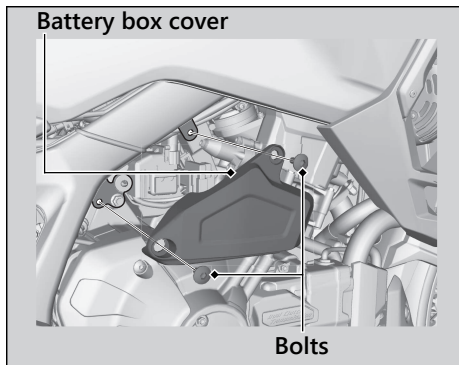

Removal

1. Remove the bolts using the hex wrench provided on the underside of the rear seat. ► P. 240
2. Remove the battery box cover.

Installation

Install the parts in the reverse order of removal.

Clip

Removal

1. Slightly, turn the pin counterclockwise by a Phillips screwdriver until it pop-up to release the lock.
2. Pull the clip out of the hole.

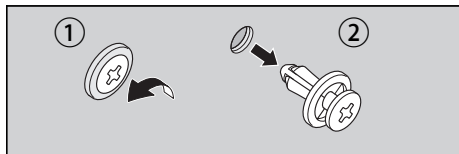

Installation

1. Insert the clip into the hole.
2. Push the pin in.

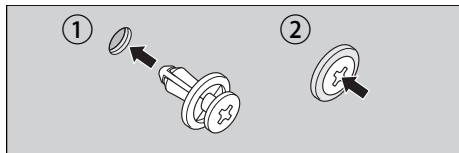

Front Seat

Removal

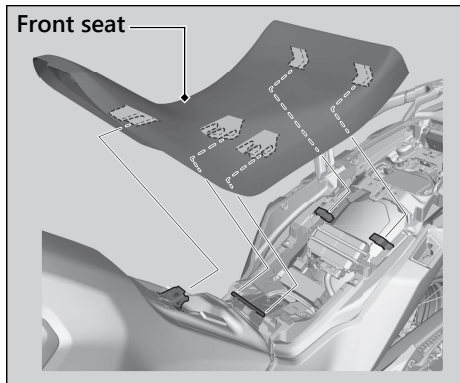

1. Remove the rear seat. ► P. 271
2. Remove the front seat while pulling it backward and upward.

Installation

1. **When setting the high seat position:**
Insert the front lower prong and center lower prongs into the front stay and center stays on the fuel tank, and insert the rear hooks into the upper slots.

When setting the low seat position:
Insert the front upper prong and center upper prongs into the front stay and center stays on the fuel tank, and insert the rear hooks into the lower slots.

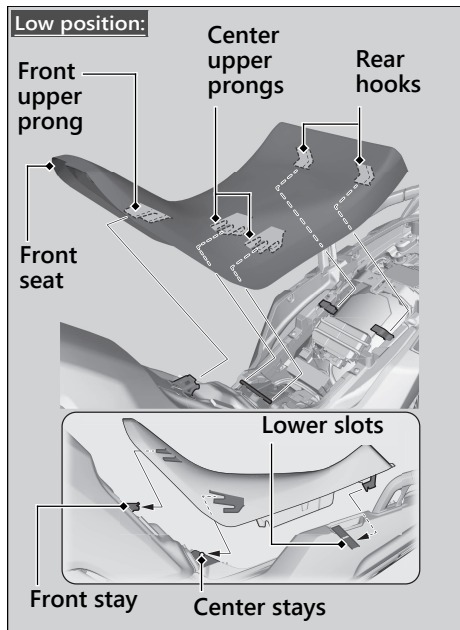
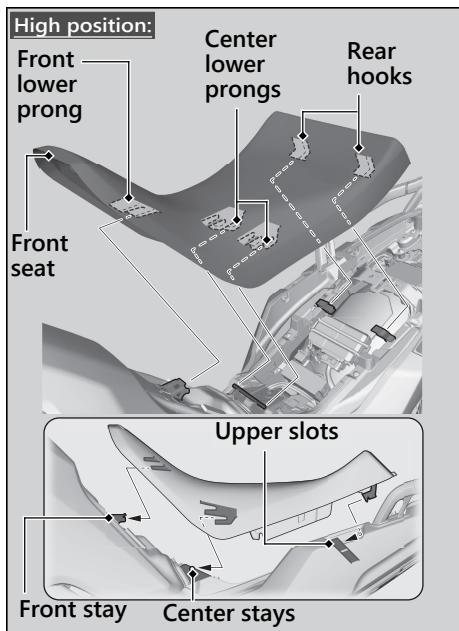

2. Install the front seat while pushing it forward and downward.
 - Make sure that the seat is locked securely in position by pulling it up lightly.
3. Install the rear seat.

Rear Seat

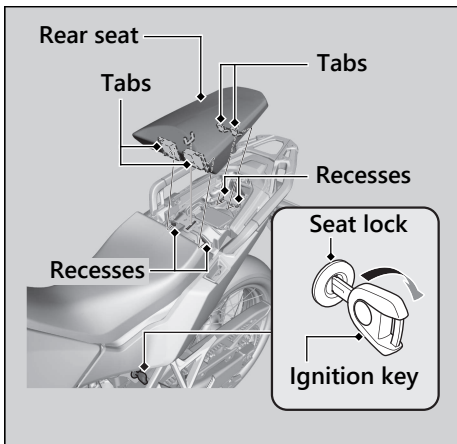

Removal

1. Insert the ignition key into the seat lock.
2. Turn the ignition key clockwise, then push the rear seat forward and up.

Installation

1. Insert the tabs into the recesses.
2. Push down on the front of the rear seat until it locks in place.
 - Make sure that the seat is locked securely in position by pulling it up lightly.

The seat locks automatically when closed. Take care not to lock your key in the compartment under the rear seat.

Tool Box

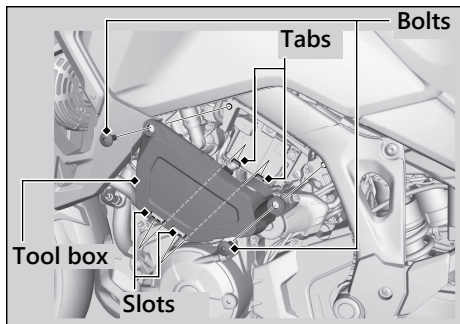

Removal

1. Remove the bolts using the hex wrench provided on the underside of the rear seat. ► P. 240
2. Remove the tool box by releasing its slots from the tabs.

Installation

Install the parts in the reverse order of removal.

Cleaning the Spark Arrester

Regular servicing prevents carbon buildup (which can diminish engine performance) and also complies with USDA regulations for regular maintenance to assure proper function. The spark arrester prevents random sparks from the combustion process in your engine from reaching the environment.

► Because of possible fire hazard, do not ride with the spark arrester removed. Riding with the spark arrester removed will also damage the surrounding parts.

1. Allow the engine and muffler to cool.
2. Remove the tail cap by removing the tail cap mounting bolts from the muffler.

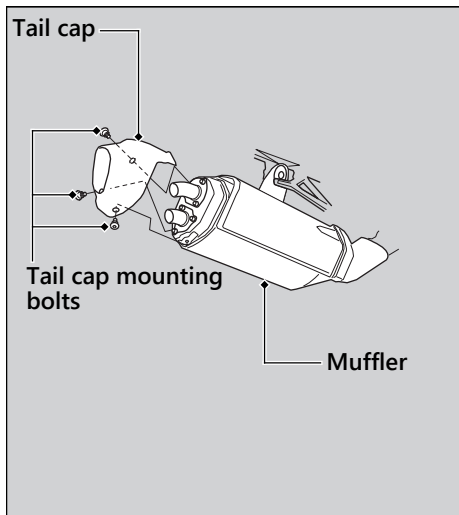

Spark Arrester ► Cleaning the Spark Arrester

3. Remove the spark arrester mounting bolts, spark arresters and gaskets from the muffler.

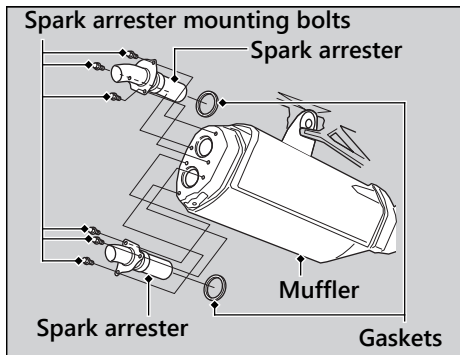

4. Use a brush to remove carbon deposits from the spark arrester screen. Be careful to avoid damaging the spark arrester screen. The spark arrester must be free of breaks and holes. Replace, if necessary. Check the gasket. Replace, if necessary.

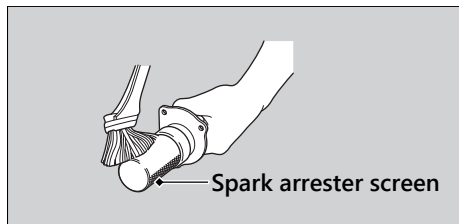

5. Install the gaskets and the spark arresters, and tighten the spark arrester mounting bolts.

Torque: 6.6 lbf-ft (9.0 N·m, 0.9 kgf·m)

6. Install the tail cap and tighten the tail cap mounting bolts.

Torque: 6.6 lbf-ft (9.0 N·m, 0.9 kgf·m)

Checking the Engine Oil

1. Place your vehicle on its side stand on a firm, level surface.
2. If the engine is cold, idle the engine for 3 to 5 minutes.
3. Turn the ignition switch to the OFF position and wait for 2 to 3 minutes.
4. Place your vehicle in an upright position on a firm, level surface.
5. Remove the dipstick and wipe it clean.
6. Insert the dipstick until it seats, but don't screw it in.
7. Check that the oil level is between the upper level and lower level marks on the dipstick.
8. Securely install the dipstick.

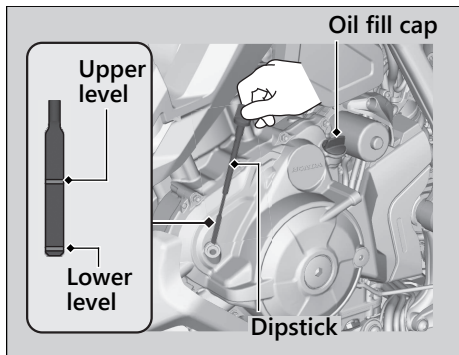

Adding Engine Oil

If the engine oil is below or near the lower level mark, add the recommended engine oil.

► P. 256, ► P. 371

1. Remove the oil fill cap. Add the recommended oil until it reaches the upper level mark.
 - Place your vehicle in an upright position on a firm, level surface when checking the oil level.
 - Do not overfill above the upper level mark.
 - Make sure no foreign objects enter the oil filler opening.
 - Wipe up any spills immediately.

2. Securely reinstall the oil fill cap.

NOTICE

Overfilling with oil or operating with insufficient oil can cause damage to your engine. Do not mix different brands and grades of oil. They may affect lubrication and clutch operation.

For the recommended oil and oil selection guidelines, see “Maintenance Fundamentals.”

► P. 256

Checking the Coolant

Check the coolant level in the reserve tank while the engine is cold.

1. Place your vehicle on a firm, level surface.
2. Hold your vehicle in an upright position.
3. Check that the coolant level is between the UPPER level and LOWER level marks on the reserve tank.

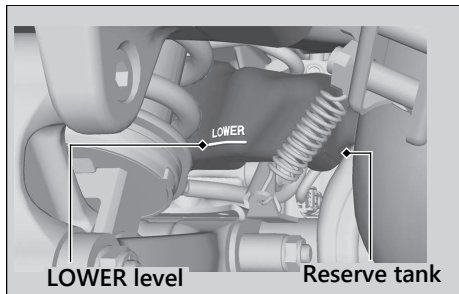
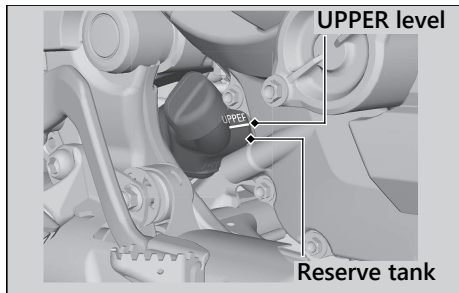

If the coolant level is dropping noticeably or the reserve tank is empty, you likely have a serious leak. Have your vehicle inspected by your dealer.

Adding Coolant

If the coolant level is below the LOWER level mark, add the recommended coolant (➤ P. 259) until the level reaches the UPPER level mark. Add fluid only from the reserve tank cap and do not remove the radiator cap.

Coolant ► Adding Coolant

1. Remove the reserve tank cap and add fluid while monitoring the coolant level.
 - Do not overfill above the UPPER level mark.
 - Make sure no foreign objects enter the reserve tank opening.
2. Securely reinstall the reserve tank cap.

⚠ WARNING

Removing the radiator cap while the engine is hot can cause the coolant to spray out, potentially scalding you.

Always let the engine and radiator cool down before removing the radiator cap.

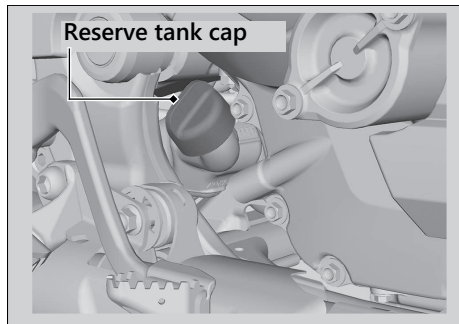

Checking Brake Fluid

1. Place your vehicle in an upright position on a firm, level surface.
2. **Front** Check that the brake fluid reservoir is horizontal and that the fluid level is above the LOWER level mark.
Rear Check that the brake fluid reservoir is horizontal and that the fluid level is between the LOWER level and UPPER level marks.

If the brake fluid level in either reservoir is below the LOWER level mark or the brake lever and pedal freeplay becomes excessive, inspect the brake pads for wear. If the brake pads are not worn, you most likely have a leak. Have your vehicle inspected by your dealer.

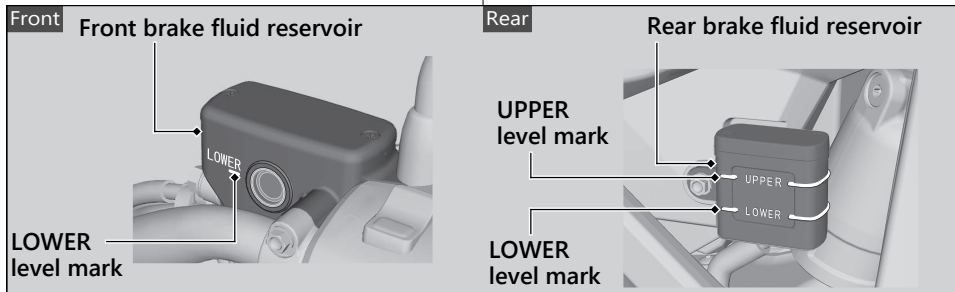

Inspecting the Brake Pads

Check the condition of the brake pad wear indicators.

Front The pads need to be replaced if a brake pad is worn to the bottom of the indicator.

Rear The pads need to be replaced if a brake pad is worn to the indicator.

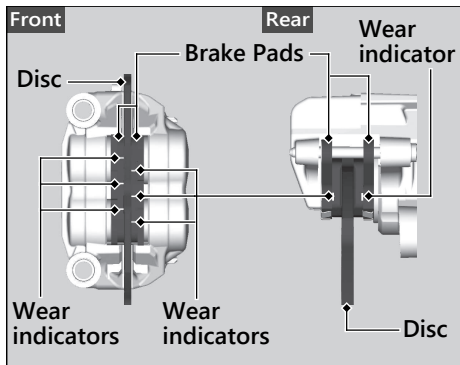

1. **Front** Inspect the brake pads from in front of the brake caliper.
 - Always inspect both left and right brake calipers.
2. **Rear** Inspect the brake pads from the rear right of the vehicle.

If necessary, have the pads replaced by your dealer.

Always replace both left and right brake pads at the same time.

Checking the Parking Brake

CRF1100D/D4

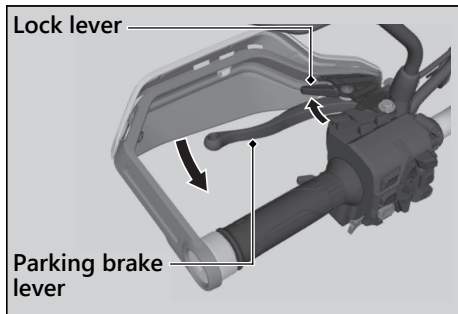

Place your vehicle on a firm, level surface. Stop the engine and push your vehicle while the parking brake is set to check the efficacy of the parking brake.

If the efficacy of the parking brake becomes weak, have the brake adjusted by your dealer.

Adjusting the Brake Light Switch

Check the operation of the brake light switch. Hold the brake light switch and turn the adjusting nut in the direction A if the switch operates too late, or turn the nut in the direction B if the switch operates too soon.

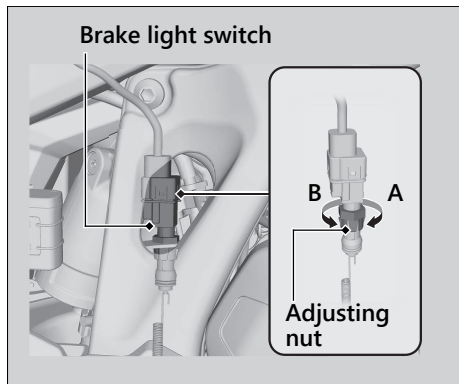

Checking the Side Stand

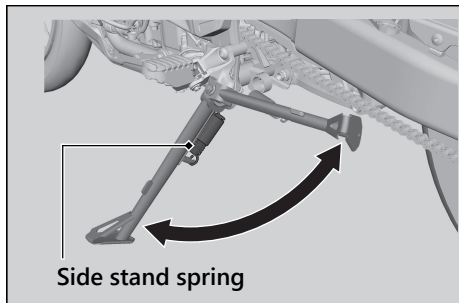

1. Check that the side stand operates smoothly. If the side stand is stiff or squeaky, clean the pivot area and lubricate the pivot bolt with clean grease.
2. Check the spring for damage or loss of tension.
3. **CRF1100A/A4**
Sit on the vehicle, shift the transmission to Neutral, and raise the side stand.
CRF1100D/D4
Sit on the vehicle and raise the side stand.
4. **CRF1100A/A4**
Start the engine, pull the clutch lever in, and shift the transmission into gear.
CRF1100D/D4
Start the engine and press the **D-S** side of N-D switch to switch the transmission into D mode.
5. Lower the side stand all the way. The engine should stop as you lower the side stand. If the engine doesn't stop, have your vehicle inspected by your dealer.

Inspecting the Drive Chain Slack

Check the drive chain slack at several points along the chain. If the slack is not constant at all points, some links may be kinked and binding. Have the chain inspected by your dealer.

1. Shift the transmission to Neutral. Stop the engine.
2. Place your vehicle on its side stand on a firm, level surface.
3. Pull the upper half of the drive chain up and check the chain slack between the drive chain and swing-arm at the end of the drive chain slider.

Drive chain slack:

1 7/8 - 2 1/16 in (48 - 53 mm)

- ▶ Do not ride your vehicle if the slack exceeds 2 3/8 in (60 mm).

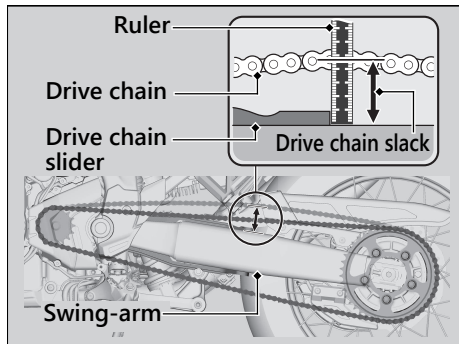

4. Roll the vehicle forward and check that the chain moves smoothly.
5. Inspect the sprockets. ➤ P. 257
6. Clean and lubricate the drive chain. ➤ P. 258

Checking the Drive Chain Slider

Check the condition of the drive chain slider. The drive chain slider will need to be replaced if the chain slider is worn to the wear limit line.

If necessary, have the drive chain slider replaced by your dealer.

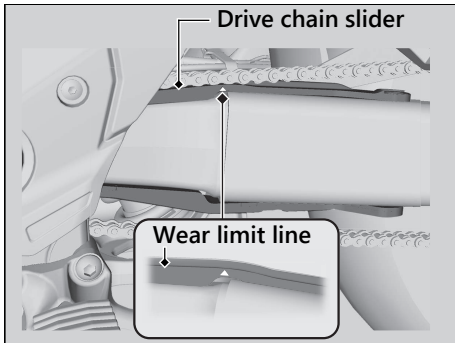

Wheels Rims & Spokes

Keeping the wheels true (round) and maintaining correct spoke tension is critical to safe vehicle operation.

Excessively loose spokes may result in instability at high speeds and possible loss of control.

It is not necessary to remove the wheels to perform the recommended service in the Maintenance Schedule.

1. Inspect the wheel rims and spokes for damage.
2. Tighten any loose spokes.
 - Use the ballpoint hexagon wrench with a length of 5.5 in (140 mm) or more.
3. Rotate the wheel slowly to see if it appears to “wobble.” If it does, the rim is out of round or not “true.” If the wobble is noticeable, see your dealer for inspection.

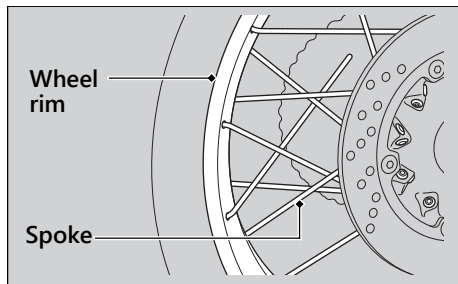

Checking the Clutch

CRF1100A/A4

Checking the Clutch Lever Freeplay

Check the clutch lever freeplay.

Freeplay at the clutch lever:

$3/8 - 13/16$ in (10 - 20 mm)

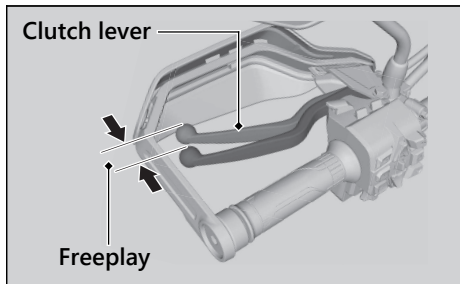

Check the clutch cable for kinks or signs of wear. If necessary, have it replaced by your dealer.

Lubricate the clutch cable with a commercially available cable lubricant to prevent premature wear and corrosion.

NOTICE

Improper freeplay adjustment can cause premature clutch wear.

Adjusting the Clutch Lever Freeplay

CRF1100A/A4

Upper Adjustment

Attempt adjustment with the upper clutch cable adjuster first.

1. Loosen the upper lock nut.
2. Turn the upper clutch cable adjuster until the freeplay is $\frac{3}{8}$ - $\frac{13}{16}$ in (10 - 20 mm).
3. Tighten the upper lock nut and check the freeplay again.

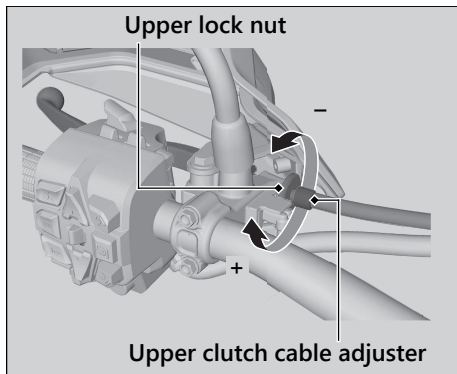

Lower Adjustment

If the upper clutch cable adjuster is threaded out near its limit, or the correct freeplay cannot be obtained, attempt adjustment with the lower clutch cable adjusting nut.

Clutch ► Adjusting the Clutch Lever Freeplay

1. Loosen the upper lock nut and turn the upper clutch cable adjuster all the way in (to provide maximum freeplay). Tighten the upper lock nut.
2. Loosen the lower lock nut.
3. Turn the lower clutch cable adjusting nut until the clutch lever freeplay is $3/8$ - $13/16$ in (10 - 20 mm).
4. Tighten the lower lock nut and check the clutch lever freeplay.
5. Start the engine, pull the clutch lever in, and shift into gear. Make sure the engine does not stall and the vehicle does not creep. Gradually release the clutch lever and open the throttle. Your vehicle should move smoothly and accelerate gradually.

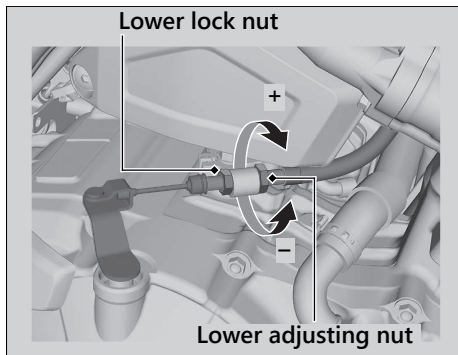

If proper adjustment cannot be obtained or the clutch does not work correctly, see your dealer.

Checking the Throttle

With the engine off, check that the throttle rotates smoothly from fully closed to fully open. If the throttle does not move smoothly or close automatically, have the vehicle inspected by your dealer.

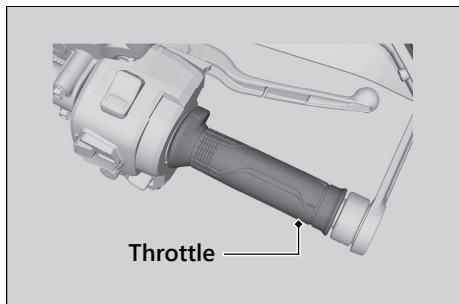

Adjusting the Brake Lever

You can adjust the distance between the brake lever and handle grip.

Adjustment method

Turn the adjuster until the numbers align with the index mark while pushing the lever forward in the desired position. After adjustment, check that the lever operates correctly before riding.

NOTICE

Do not turn the adjuster beyond its natural limit.

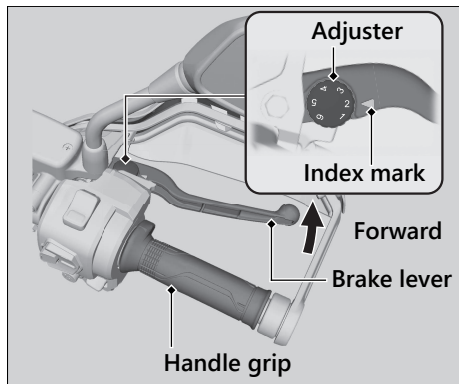

Adjusting the Front Suspension

Spring Preload

CRF1100A/D

You can adjust the spring preload by the adjuster to suit the load or the road surface. Turn the adjuster using a suitable box end wrench.

The spring preload adjuster has 15 turns. Turn clockwise to increase spring preload (hard), or turn counterclockwise to decrease spring preload (soft).

CRF1100A

The standard position is the 3 turns from the full soft position.

CRF1100D

The standard position is the 6 turns from the full soft position.

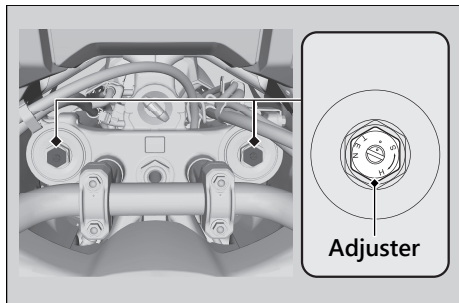

NOTICE

Do not turn the adjuster beyond its limits. Adjust both left and right forks to the same spring preload.

Rebound Damping

CRF1100A/D

You can adjust the rebound damping by the adjuster to suit the load or the road surface. Turn the adjuster using the Standard/Phillips screwdriver provided on the underside of the rear seat. ➤ P. 240

The rebound damping adjuster has 3 turns or more.

Turn clockwise to increase rebound damping (hard), or turn counterclockwise to decrease rebound damping (soft).

The standard position is 2 3/4 turns from the maximum setting so that the punch mark on the adjuster aligns with the reference punch mark.

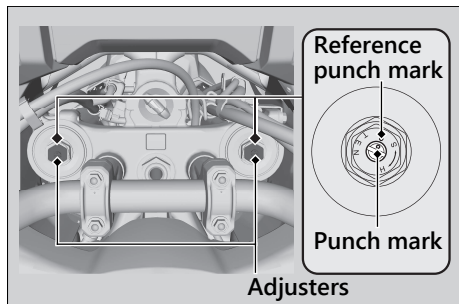

NOTICE

Do not turn the adjuster beyond its limits. Adjust both left and right forks to the same rebound damping.

Compression Damping

CRF1100A/D

You can adjust the compression damping by the adjuster to suit the load or the road surface.

Turn the adjuster using the Standard/Phillips screwdriver provided on the underside of the rear seat. ► P. 240

The compression damping adjuster has 12 position or more.

Turn clockwise to increase compression damping (hard), or turn counterclockwise to decrease compression damping (soft).

The standard position is 9 clicks from the maximum setting.

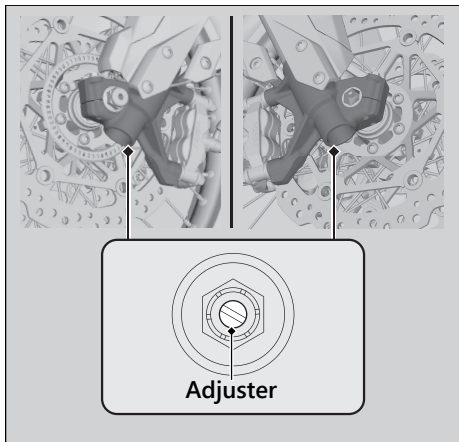

NOTICE

Do not turn the adjuster beyond its limits. Adjust both left and right forks to the same compression damping.

Damping

CRF1100A4/D4

- When the riding mode is changed, front suspension damping is automatically selected to a setting corresponding to the riding mode. ➤ P. 143
- You can change the [S] [Overall] and [Front] on the [USER 1 MODE] and [USER 2 MODE] of the riding mode. ➤ P. 74

- **Available setting range:**
[Overall]: [H] Hard / [M] Medium / [S] Soft / [O] Off Road
[Front]: [-]/[Medium]/[+]
- **Default:**
[Overall]
 [USER 1 MODE]: [M] Medium
 [USER 2 MODE]: [S] Soft
[Front]: [Medium]

Adjusting the Rear Suspension

Spring Preload

CRF1100A/D

You can adjust the spring preload by the adjuster knob to suit the load or the road surface. The spring preload adjuster has 35 position or more. Turn the clockwise to increase spring preload (high), or turn counterclockwise to decrease spring preload (low).

Turn the adjuster counterclockwise (low) until it will no longer turn (lightly seat). Turn the adjuster clockwise (high) until it clicks. This click is position 0.

The standard position is 7 clicks from the minimum setting.

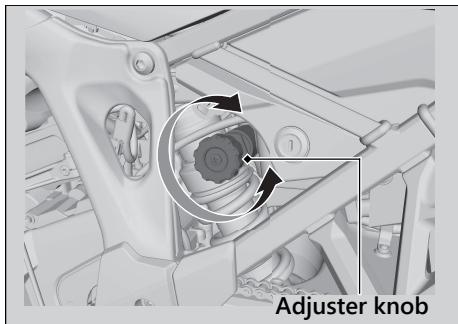

NOTICE

Do not turn the adjuster beyond its limits.

NOTICE

The rear shock absorber damper unit contains high pressure nitrogen gas. Do not attempt to disassemble, service, or improperly dispose of the damper. See your dealer.

Other Adjustments ► Adjusting the Rear Suspension

CRF1100A4/D4

The electrically adjustable suspension allows the preload of the rear suspension to be adjusted in four levels according to riding and load conditions.

The rear suspension spring preload adjustment can be changed when your vehicle is stopped or when riding at a constant speed without sudden acceleration, sudden deceleration, wheelspin, wheelies or jumps, etc.

When riding on rough roads or when using tires with diameters that are extremely different from the recommended tires, the system may not operate even when riding is stable.

If you change the preload after you start riding, the grounding ability will change as the vehicle height changes. Be careful when changing the preload while riding.





1. Select the gold image display. ► P. 78
2. Select page 4. ► P. 43
3. Press the **[ENT]** switch.
4. Select [PRELOAD].
5. Push the ◀ or ▶ of the ◀ ▶ sel left/right switch until the desired value is displayed.



6. Press the ↶ back switch.

You can also perform the above settings by using the touch screen.

The rear suspension adjustment provides the following settings.

Status icon	Riding condition
	Rider only (Minimum preload)
	Rider and luggage
	Rider and passenger
	Rider, passenger and luggage (Maximum preload)

Default: Rider only

- You can change the [PRELOAD] [Preload] on the [USER 1 MODE] and [USER 2 MODE] of the riding mode. 📖 P. 74

NOTICE

The rear shock absorber damper unit contains high pressure nitrogen gas. Do not attempt to disassemble, service, or improperly dispose of the damper. See your dealer.

Rebound Damping

CRF1100A/D

You can adjust the rebound damping by the adjuster to suit the load or the road surface. Turn the adjuster using the Standard/Phillips screwdriver provided on the underside of the rear seat. ► P. 240

Turn clockwise to increase rebound damping (hard), or turn counterclockwise to decrease rebound damping (soft).

The standard position is 8 clicks from the maximum setting so that the punch mark on the adjuster aligns with the reference punch mark.

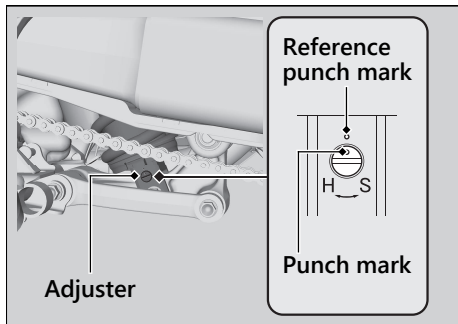

NOTICE

Do not turn the adjuster beyond its limits.

NOTICE

The rear shock absorber damper unit contains high pressure nitrogen gas. Do not attempt to disassemble, service, or improperly dispose of the damper. See your dealer.

Compression Damping

CRF1100A/D

You can adjust the compression damping by the adjuster to suit the load or the road surface.

Turn the adjuster using the Standard/Phillips screwdriver provided on the underside of the rear seat. ➔ P. 240

Turn clockwise to increase compression damping (hard), or turn counterclockwise to decrease compression damping (soft).

The standard position is 12 clicks from the maximum setting so that the punch mark on the adjuster aligns with the reference punch mark.

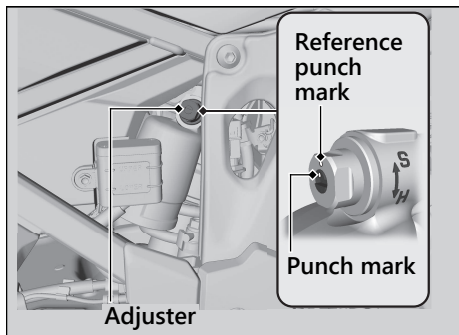

NOTICE

Do not turn the adjuster beyond its limits.

NOTICE

The rear shock absorber damper unit contains high pressure nitrogen gas. Do not attempt to disassemble, service, or improperly dispose of the damper. See your dealer.

Damping

CRF1100A4/D4

- When the riding mode is changed, rear suspension damping is automatically selected to a setting corresponding to the riding mode. ➤ P. 143
- You can change the [S] [Overall] and [Rear] on the [USER 1 MODE] and [USER 2 MODE] of the riding mode. ➤ P. 74

- **Available setting range:**
[Overall]: [H] Hard / [M] Medium / [S] Soft / [O] Off Road
[Rear]: [-]/[Medium]/[+]
- **Default:**
[Overall]
[USER 1 MODE]: [M] Medium
[USER 2 MODE]: [S] Soft
[Rear]: [Medium]

NOTICE

The rear shock absorber damper unit contains high pressure nitrogen gas. Do not attempt to disassemble, service, or improperly dispose of the damper. See your dealer.

Adjusting the Windscreen Height

You can adjust the windscreen height 1 of 5 positions.

Windscreen height indicator shows the windscreen height.

The standard position is 1.

► Do not adjust the windscreen while riding.

1. Push the right and left lock levers to unlock the screen.
2. Continue to push the right and left lock levers, move the right and left lock levers upward or downward to raise or lower the windscreen.

3. Release the right and left lock levers at the desired position while checking height the indicator.
 - Make sure that the windscreen is locked securely by slightly moving the right and left lock levers up or down.

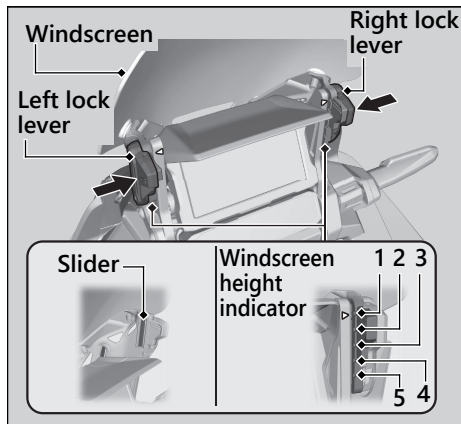

Other Adjustments ► Adjusting the Windscreen Height

If the windscreen does not move smoothly, clean the sliders using a sponge or a soft towel with neutral detergent to remove dust.

► Do not apply a lubricant to the sliders.

If the windscreen does not move smoothly after cleaning the sliders, have your vehicle inspected by your dealer.

Troubleshooting

Engine Will Not Start	P. 306		
Overheating (Segment H flashes in coolant temperature gauge)	P. 307		
Warning Indicators On or Flashing	P. 308		
Low Oil Pressure Indicator	P. 308		
PGM-FI (Programmed Fuel Injection)			
Malfunction Indicator Lamp (MIL).....	P. 308		
ABS (Anti-lock Brake System) Indicator	P. 309		
Torque Control Indicator.....	P. 310		
If the “-” Indicator is Blinking in the Gear Position Window While Riding	P. 311		
Other Warning Indications	P. 312		
Fuel Gauge Failure Indication.....	P. 312		
		Coolant Temperature Gauge Failure	
		Indication	P. 313
		Handle Grip Heater Failure Indication	P. 313
		Tire Puncture	P. 314
		Audio System Trouble	P. 315
		Electrical Trouble	P. 330
		Battery Goes Dead.....	P. 330
		Burned-out Light Bulb	P. 330
		Blown Fuse.....	P. 331

Starter Motor Operates But Engine Does Not Start

Check the following items:

- Check the correct engine starting sequence. ➔ P. 216
- Check that there is gasoline in the fuel tank.
- Check if the PGM-FI malfunction indicator lamp (MIL) is on.
 - ▶ If the indicator lamp is on, contact your dealer as soon as possible.

Starter Motor Does Not Operate

Check the following items:

- Check the correct engine starting sequence. ➔ P. 216
- Check for a blown fuse. ➔ P. 331
- Check for a loose battery connection (➔ P. 265) or battery terminal corrosion (➔ P. 254).
- Check the condition of the battery. ➔ P. 330

If the problem continues, have your vehicle inspected by your dealer.

Overheating (Segment H flashes in coolant temperature gauge)

The engine is overheating when the following occurs:

- All segments turn red and the segment H flashes in the coolant temperature gauge.
- Acceleration becomes sluggish.
If this occurs, pull safely to the side of the road and perform the following procedure.

Extended fast idling may cause all segments turn red and the segment H to flash.

NOTICE

Continuing to ride with an overheated engine can cause serious damage to the engine.

1. Stop the engine using the ignition switch, and then turn the ignition switch to the ON position.

2. Check that the radiator fan is operating, and then turn the ignition switch to the OFF position.

If the fan is not operating:

Suspect a fault. Do not start the engine. Transport your vehicle to your dealer.

If the fan is operating:

Allow the engine to cool with the ignition switch in the OFF position.

3. After the engine has cooled, inspect the radiator hose and check if there is a leak.
➔ P. 277

If there is a leak:

Do not start the engine. Transport your vehicle to your dealer.

4. Check the coolant level in the reserve tank. ➔ P. 277
▶ Add coolant as necessary.
5. If 1-4 check normal, you may continue riding, but closely monitor the temperature gauge.

Low Oil Pressure Indicator

If the low oil pressure indicator comes on, pull safely to the side of the road and stop the engine.

NOTICE

Continuing to ride with low oil pressure can cause serious damage to the engine.

1. Check the engine oil level, and add oil as necessary. 📄 P. 275, 📄 P. 276
2. Start the engine.
 - ▶ Only continue riding if the low oil pressure indicator goes off.

Rapid acceleration may momentarily cause the low oil pressure indicator to come on, especially if the oil is at or near the low level. If the low oil pressure indicator stays on when the oil level is at the proper level, stop the engine and contact your dealer.

If the engine oil level goes down rapidly, your vehicle may have a leak or another serious problem. Have your vehicle inspected by your dealer.

PGM-FI (Programmed Fuel Injection) Malfunction Indicator Lamp (MIL)

If the indicator comes on while riding, you may have a serious problem with the PGM-FI system. Reduce speed and have your vehicle inspected by your dealer as soon as possible.

ABS (Anti-lock Brake System) Indicator

If the indicator operates in one of the following ways, you may have a serious problem with the ABS. Reduce your speed and have your vehicle inspected by your dealer as soon as possible.

- Indicator comes on or starts flashing while riding.
- Indicator does not come on when the ignition switch is in the ON position.
- Indicator does not go off at speeds above 6 mph (10 km/h).

If the ABS indicator stays on, your brakes will continue to work as a conventional system, but without the anti-locking function.

The ABS indicator may flash if you turn the rear wheel while the rear wheel is lifted off the ground. In this case, turn the ignition switch to the OFF position, and then to the ON position again. The ABS indicator will go off after your speed reaches 19 mph (30 km/h).

Torque Control Indicator

If the indicator operates in one of the following ways, you may have a serious problem with the Torque Control. Reduce your speed and have your vehicle inspected by your dealer as soon as possible.

- Indicator comes and stays on (solid) while riding.
- Indicator does not come on when the ignition switch is turned to the ON position.
- Indicator does not go off at speeds above 3 mph (5 km/h).

Even when the Torque Control indicator is on, your vehicle will have normal riding ability without Torque Control function.

- When the indicator comes on while the Torque Control is in operation, you will have to completely close the throttle to regain normal riding ability.

The Torque Control indicator may come on if you rotate the rear wheel while your vehicle is lifted off the ground. In this case, turn the ignition switch to the OFF position, and then to the ON position again. The Torque Control indicator will go off after your speed reaches 3 mph (5 km/h).

If the “-” Indicator is Blinking in the Gear Position Window While Riding

CRF1100D/D4

If the “-” indicator is blinking while riding, you may have a serious problem with the Dual Clutch Transmission system.

Park your vehicle in a safe place and have your vehicle inspected by a dealer immediately.

It may be possible to ride your vehicle by following the steps below.

1. Turn the ignition switch to the OFF position.
2. Turn the ignition switch to the ON position and start the engine.

If you cannot start the engine:

Turn the ignition switch to the OFF position and move the vehicle back and forth slightly (to disengage the gears).

Turn the ignition switch to the ON position again and start the engine.

If you still cannot start the engine:

Start the engine while applying the brake lever or pressing the brake pedal.

If you can shift from N to D mode:

When a gear position is shown in the gear position indicator, you can ride in that gear. Take your vehicle to your dealer riding at a safe speed.

If you can't shift from N to D mode and the “-” indicator is blinking:

Damage is preventing you from riding. Have your vehicle inspected by your dealer immediately.

Fuel Gauge Failure Indication

If the fuel system has an error, all segments will blink as shown in the illustration.

If these occur, see your dealer as soon as possible.

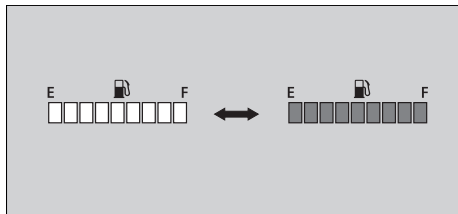

Coolant Temperature Gauge Failure Indication

If the cooling system has an error, all segments will blink as shown in the illustration.

If this occurs, see your dealer as soon as possible.

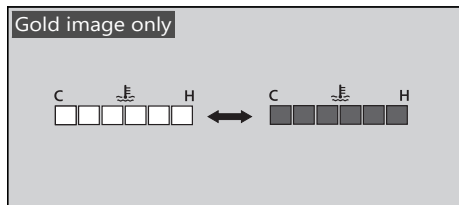

Handle Grip Heater Failure Indication

CRF1100A4/D4

If the handle grip heater system has an error, the handle grip heater status icon will blink. If these occur, see your dealer as soon as possible.

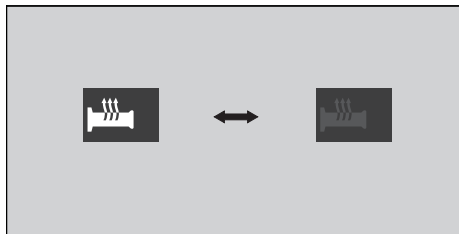

Tire Puncture

Repairing a puncture or removing a wheel requires special tools and technical expertise. We recommend you have this type of service performed by your dealer.

After an emergency repair, always have the tire inspected/replaced by your dealer.

Emergency Repair Using a Tire Repair Kit

If your tire has a minor puncture, you can make an emergency repair using a tubeless tire repair kit.

Follow the instructions provided with the emergency tire repair kit.

Riding your vehicle with a temporary tire repair is very risky. Do not exceed 30 mph (50 km/h). Have the tire replaced by your dealer as soon as possible.

WARNING

Riding your vehicle with a temporary tire repair can be risky. If the temporary repair fails, you can crash and be seriously injured or killed.

If you must ride with a temporary tire repair, ride slowly and carefully and do not exceed 30 mph (50 km/h) until the tire is replaced.

Audio System Trouble

Symptom	Cause/remedy
Unable to pair <i>Bluetooth</i> ® device	Some <i>Bluetooth</i> ® devices and application software you use may be incompatible with the audio system and/or the operable functions may be limited.
	Check that the audio system and <i>Bluetooth</i> ® device are both in pairing mode. ➤ P. 155 ➤ P. 160
	The audio system may not be properly connected when another <i>Bluetooth</i> ® device is being paired at the same time. Check your surroundings to make sure no other device being paired is present before re-pairing. Presence of a <i>Bluetooth</i> ® device in the vicinity sometimes affects the pairing due to radio wave interference, etc.
	When connecting a <i>Bluetooth</i> ® device, make sure no other <i>Bluetooth</i> ® device readied for pairing is present. Presence of a <i>Bluetooth</i> ® device in the vicinity sometimes affects the pairing due to radio wave interference, etc.
	When you repeatedly fail in pairing, delete the paired device once, then try pairing again. ➤ P. 155 ➤ P. 160

Symptom	Cause/remedy
<p>Unable to connect <i>Bluetooth</i>® device</p>	<p>Depending on the <i>Bluetooth</i>® device and application software you use, it may take some time for the audio system to connect to a device and to start playing an audio file.</p>
	<p>The connection may be temporarily disconnected when starting the engine, which is normal and not a malfunction. The <i>Bluetooth</i>® device will be reconnected after the engine is started.</p>
	<p>Check that your <i>Bluetooth</i>® device has been paired. Refer to the instruction manual of your <i>Bluetooth</i>® device and check that your <i>Bluetooth</i>® device is in connectable state.</p>

Symptom	Cause/remedy
Unable to connect <i>Bluetooth</i> ® phone device	Some <i>Bluetooth</i> ® devices and application software you use may not connect automatically. For connecting, follow the instructions in the instruction manual of your <i>Bluetooth</i> ® device.
	The <i>Bluetooth</i> ® devices that can be connected at the same time are limited to one <i>Bluetooth</i> ® device and two <i>Bluetooth</i> ® headsets.
	If the problem continues after the above-described inspection, delete the paired device once, then try pairing again. ➤ P. 155 ➤ P. 160
	The <i>Bluetooth</i> ® connection cannot be established while launching Apple CarPlay. Quit Apple CarPlay, then try pairing again. ➤ P. 193 ➤ P. 155
While connected to Apple CarPlay, <i>Bluetooth</i> ® function is disabled.	

Symptom	Cause/remedy
Connected, but does not play.	<p>Some <i>Bluetooth</i>® devices and application software you use may be incompatible with the audio system and/or audio files may not be played properly. Check the recommended specifications. ➤ P. 154</p>
	<p>Depending on the <i>Bluetooth</i>® device and application software you use, an audio file may not play automatically. For playing, follow the instructions in the instruction manual of your <i>Bluetooth</i>® device.</p>
	<p>Depending on the <i>Bluetooth</i>® device and application software you use, an audio file may not play normally after receiving a telephone call, etc. Check that your <i>Bluetooth</i>® device is in playable state.</p>
Takes some time to start playing after turning the power on or changing the audio mode.	<p>Right after the power is turned on or the audio mode is changed, the audio system may take some time to connect to an audio device and to start playing an audio file. Also, the audio system may not allow any audio control operation while preparing to play an audio file.</p>

Symptom	Cause/remedy
Sounds skip Noises mix	Presence of another <i>Bluetooth</i> ® device or a device that emits electromagnetic waves such as communication equipment in the vicinity sometimes affects the communication.
	Due to the characteristics of <i>Bluetooth</i> ®, though in rare cases, the system operation may become unstable. When it remains unstable, turn off the power to the audio system or the device being used, and then turn it on again.
	The storage location of the <i>Bluetooth</i> ® device sometimes affects the audio system and communication. When sounds skip or noises mix, change the location of the device. For example, when the device is kept in a pocket of clothing sandwiched in between the rider and passenger, the communication may be affected. Also, weather, buildings in the vicinity, road conditions, etc. can sometimes affect the communication.

Symptom	Cause/remedy
Sounds skip Noises mix	Depending on the <i>Bluetooth</i> ® device and application software you use, an audio file may not play normally after receiving a telephone call, etc. Turn off the power to the audio system and then turn it on again. If the skipping of sounds or mixing of noises continues, check the status of your <i>Bluetooth</i> ® device.
	If the skipping of sounds or mixing of noises continues, delete the paired device once, then try pairing again. ➤ P. 163
	Check the recommended specifications. ➤ P. 154

Symptom	Cause/remedy
Audio volume from headset is low/high	Adjust the volume while in the individual modes. ➤ P. 92
	Check the volume setting of the <i>Bluetooth</i> ® audio device.
	Check the volume setting of the paired headset.
No or inaccurate display	Depending on the audio device and the audio file, nothing may be displayed or the display may be inaccurate in some cases. Check the information on available tags. ➤ P. 172
	When the information in an audio file such as the artist name and track title is in a non-compliant tag format, it may be indicated by "☒" or no information will be shown.

Audio System Trouble

Symptom	Cause/remedy
<i>Bluetooth</i> ® handsfree calling is not functioning	Connected <i>Bluetooth</i> ® device may be an unsupported device. Check the supported <i>Bluetooth</i> ® version/profiles. ➤ P. 154
	When the <i>Bluetooth</i> ® connection is unstable due to surrounding conditions or radio wave conditions, the handsfree calling functions may not be available.
	To use <i>Bluetooth</i> ® handsfree calling, a headset connection is necessary. Connect a paired headset. ➤ P. 160
During a call, headset volume is low/high	Adjust the volume during a call. ➤ P. 92
Passenger's headset has no sound	Passenger headset only outputs music. Music playback is interrupted while using the handsfree phone or Siri.

Symptom	Cause/remedy
<i>Bluetooth</i> ® Handsfree calling problems	Depending on the connection status, the times displayed in call history on the vehicle side or the phone side may differ.
	Depending on your mobile carrier plan, available functions may differ.
	A display delay may occur depending on the number of phone books, call history and music data etc. stored in the connected device.

Symptom	Cause/remedy
Apple CarPlay is not functioning	Connected iPhone may be an unsupported model. Check the models compatible with Apple CarPlay. ➤ P. 188
	Connected iPhone may be an unsupported iOS version. Update the iPhone to the newer version.
	To use Apple CarPlay, a headset connection is necessary. Connect a paired headset. ➤ P. 160
	When a mobile network communication is unstable due to surrounding conditions or signal strength conditions, Apple CarPlay functions may not be available.

Symptom	Cause/remedy
Apple CarPlay is not functioning	When the paired headset connection is broken due to headset battery depletion or communication failure, Apple CarPlay cannot be used until the connection is restored.
	The screen will not switch to Apple CarPlay automatically, other than when the ignition switch is turned to the OFF position with Apple CarPlay activated.
	Some USB cables may be incompatible with Apple CarPlay. Use certified cable to connect the iPhone.
	You have not agreed to enable Apple CarPlay. Reconnect the iPhone and enable CarPlay on the disclaimer screen. ➤ P. 191
	Apple CarPlay setting on your iPhone may be disabled. Disconnect iPhone and enable the Apple CarPlay setting on your iPhone.

Symptom	Cause/remedy
Android Auto™ is not functioning	Connected Android™ phone may be unsupported model. Check the compatible model with Android Auto™ . ➤ P. 202
	Connected Android™ phone may be unsupported Android™ version. Update the Android™ phone to the newer version.
	To use full function of Android Auto™ , a headset connection is necessary. Connect a paired headset. ➤ P. 160
	When a mobile network communication is unstable due to surrounding conditions or signal strength conditions, Android Auto™ functions may not be available.

Symptom	Cause/remedy
Android Auto™ is not functioning	When the paired headset connection is broken due to headset battery depletion or communication failure, go back to the Home screen, and pair the headset connection again.
	Some USB cables may be incompatible with Android Auto™ . For Android Auto™ , the USB cables should be certified by USB-IF to be compliant with USB 2.0 Standard.
	You have not agreed to enable Android Auto™ . Reconnect the Android™ phone and enable to use Android Auto™ on the disclaimer screen.  P. 211
	Android Auto™ setting on your Android™ phone may be disabled. Disconnect Android™ phone and enable the Android Auto™ setting on your Android™ phone.

Audio System Trouble

Symptom	Cause/remedy
Connected, but does not operate Apple CarPlay/ Android Auto™ .	You cannot operate Apple CarPlay/ Android Auto™ by the touch panel while the vehicle is in motion. Operate with the left handlebar switches or park your vehicle in a safe place, then operate.
Some functions of Apple CarPlay/ Android Auto™ not available.	Some functions may be limited due to condition of mobile network communication.
Apple CarPlay/ Android Auto™ screen is too dark/ bright	Selecting [Background] menu in [Settings], you can select white mode or black mode in the navigation map or an application such as Maps, also adjust backlight brightness by [Brightness] menu in [Settings] ➡ P. 81 ➡ P. 80.
Audio system cannot operate.	Certain manual functions and settings are disabled or inoperable while the vehicle is in motion. You cannot select a greyed-out menu until the vehicle is stopped.
When turning the ignition switch to the OFF and ON position continuously.	Since the system restart takes time, it may take time until the screen is appears.

Symptom	Cause/remedy
High temperature/ overcurrent protection	To protect the system, some operations may be limited temporarily. The system automatically recovers after the cause is solved.
Software update	The statements in this owner's manual may not match your vehicle's Audio System after performing the software update.

If the problem continues after the above-described inspection, have your vehicle inspected by your dealer.

Battery Goes Dead

Battery charging is needed.

A battery charger recommended by your lithium-ion (li-ion) battery manufacturer is needed for battery charging.

Contact your dealer before charging the battery.

Remove the battery from the vehicle before charging.

NOTICE

Only use a charger recommended by your lithium-ion (li-ion) battery manufacturer. Using a battery charger that is not recommended can cause permanent damage to your battery.

If the battery does not recover after recharging, contact your dealer.

NOTICE

Do not jump-start, as this can damage your vehicle's electrical system and battery. Bump starting is not recommended.

Burned-out Light Bulb

All light bulbs on the vehicle are LEDs. If there is an LED which is not turned on, see your dealer for servicing.

Blown Fuse

Before handling fuses, see "Inspecting and Replacing Fuses." ► P. 255

■ Fuse Box Fuses & ABS FSR Fuse

1. Remove the front seat. ► P. 268
2. Open the fuse box covers.
3. Pull the fuses out with the fuse puller provided on the underside of the rear seat (► P. 240) one by one check for a blown fuse. Always replace a blown fuse with a spare fuse of the same rating.
4. Close the fuse box covers.
5. Reinstall the front seat.

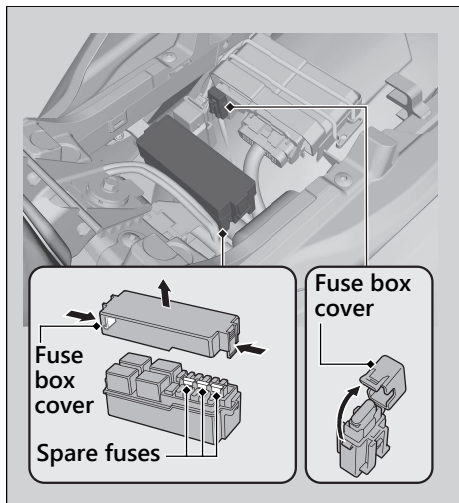

Main Fuse & ABS Main Fuse

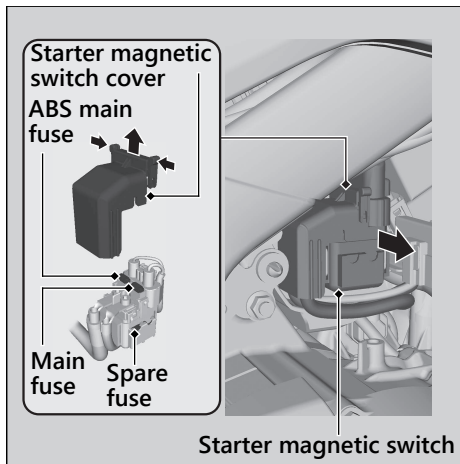

1. Remove the battery box cover. ► P. 266
2. Pull the starter magnetic switch out.
3. Remove the starter magnetic switch cover.
4. Pull the main fuse and ABS main fuse out with the fuse puller provided on the underside of the rear seat (► P. 240) one by one check for a blown fuse. Always replace a blown fuse with a spare fuse of the same rating.
 - Spare main fuse and spare ABS main fuse are provided in the starter magnetic switch.
5. Reinstall parts in the reverse order of removal.

FI Fuse & Main 2 Fuse

CRF1100A/A4

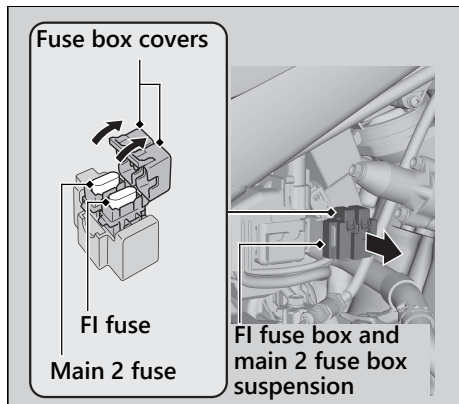

1. Remove the battery box cover. ► P. 266
2. Pull the FI fuse box and main 2 fuse box suspension out.
3. Open the fuse box cover.
4. Pull the FI fuse and main 2 fuse out with the fuse puller provided on the underside of the rear seat (► P. 240) and check for a blown fuse. Always replace a blown fuse with a spare fuse of the same rating.
 - Spare FI fuse is provided in the fuse box under the front seat. ► P. 331
 - Spare main 2 fuse is provided in the starter magnetic switch.
5. Reinstall parts in the reverse order of removal.

FI Fuse & Main 2 Fuse & DCT Main Fuse

CRF1100D/D4

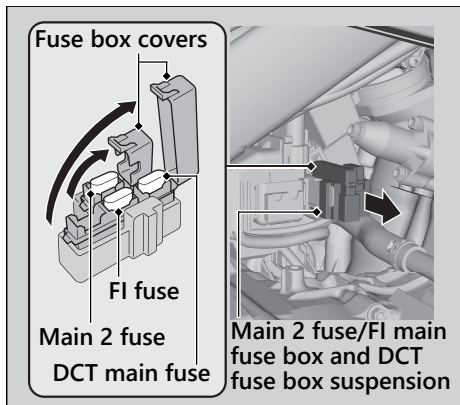

1. Remove the battery box cover. ► P. 266
2. Pull the main 2 fuse/FI main fuse box and DCT fuse box suspension out.
3. Open the fuse box covers.
4. Pull the FI fuse, main 2 fuse and DCT main fuse out with the fuse puller provided on the underside of the rear seat (► P. 240) one by one check for a blown fuse. Always replace a blown fuse with a spare fuse of the same rating.
 - Spare FI fuse is provided in the fuse box under the front seat. ► P. 331
 - Spare main 2 fuse and spare DCT main fuse are provided in the starter magnetic switch.
5. Reinstall parts in the reverse order of removal.

NOTICE

If a fuse fails repeatedly, you likely have an electrical problem. Have your vehicle inspected by your dealer.

Information

Keys.....	P. 336
Instruments, Controls, & Other Features...	P. 337
Caring for Your Vehicle.....	P. 341
Storing Your Vehicle.....	P. 346
Transporting Your Vehicle	P. 347
You & the Environment	P. 348
Vehicle Identification Number.....	P. 349
Emission Control Systems	P. 350
Catalytic Converter	P. 354
Oxygenated Fuels.....	P. 355
Authorized Manuals	P. 356
Warranty Coverage and Service	P. 357
Honda Contacts.....	P. 360
Reporting Safety Defects	P. 362

Legal Information on Apple CarPlay/Android Auto™	P. 364
Software Upgrades	P. 368

Keys

Ignition Key

This vehicle has two ignition keys and a key tag with a key number and a bar code. Store the spare key and the key tag in a safe location. To make a duplicate key, take the spare key and the key tag to your dealer or a locksmith.

If you lose all ignition keys and the key tag, the ignition switch assembly will probably have to be removed by your dealer to determine the key number.

A metal key holder may cause damage to the area surrounding the ignition switch.

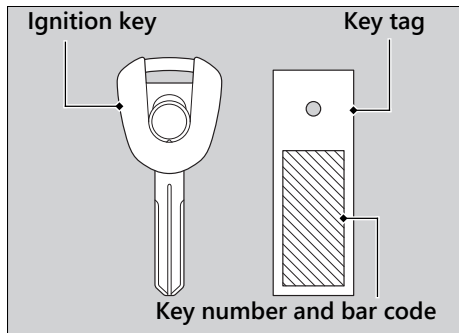

Instruments, Controls, & Other Features

Ignition Switch

Leaving the ignition switch in the ON position with the engine stopped will drain the battery.

Do not turn the key while riding.

Engine Stop Switch

Do not use the engine stop switch except in an emergency. Doing so when riding will cause the engine to suddenly turn off, making riding unsafe.

If you stop the engine using the engine stop switch, turn the ignition switch to the OFF position. Failing to do so will drain the battery.

Odometer

The display remains at 999,999 when the odometer exceeds 999,999.

Tripmeter

Each tripmeter resets to 0.0 when the trip mileage exceeds 9,999.9.

Audio system

1: E-Label instructions as listed below

Viewing E-Label Compliance and Regulatory Information

1.Select the Clock

2.Select Settings > Regulatory

2: FCC 2 Part Statement

FCC Compliance

This device complies with part 15 of the FCC Rules. Operation is subject to the following two Conditions: (1) this device may not cause harmful interference, and (2) this device must accept any interference received, including interference that may cause undesired operation.

This equipment has been tested and found to comply with the limits for a Class B digital device, pursuant to part 15 of the FCC rules. These limits are designed to provide reasonable protection against harmful interference in a residential installation. This

equipment generates, uses, and can radiate radio frequency energy and may cause harmful interference to radio communications if not installed and used in accordance with the instructions. However, there is no guarantee that interference will not occur in a particular installation. If this equipment does cause harmful interference to radio or television receptions, which can be determined by turning the equipment off and on, the user is encouraged to try to correct the interference by one of the following measures:

- Reorient or relocate the receiving antenna.
- Increase the separation between the equipment and the receiver.
- Connect the equipment into an outlet that is on a different circuit from the GPS device.
- Consult the dealer or an experienced radio/TV technician for help.

This product does not contain any user-serviceable parts. Repairs should only be made by an authorized Garmin service center. Unauthorized repairs or modifications could result in permanent damage to the equipment, and void your warranty and your authority to operate this device under Part 15 regulations.

3: ISED compliance statements

Innovation, Science and Economic Development Canada Compliance

This device complies with Innovation, Science and Economic Development Canada license-exempt RSS standard(s). Operation is subject to the following two conditions: (1) this device may not cause interference, and (2) this device must accept any interference, including interference that may cause undesired operation of the device.

Innovation, Sciences et Développement économique Canada - Conformité

Cet appareil est conforme aux normes RSS sans licence du ministère Innovation, Sciences et Développement économique Canada. Son fonctionnement est soumis aux deux conditions suivantes:

(1) cet périphérique ne doit pas causer d'interférences, et (2) doit accepter toute interférence, y compris les interférences pouvant entraîner un fonctionnement indésirable de l'appareil.

Document Bag

The owner's manual, registration, and insurance information can be stored in the plastic document bag located on the underside of the front seat. 📄 P. 239

Ignition Cut-off System

IMU (Inertia Measurement Unit) sensor automatically stops the engine and fuel pump if the vehicle falls over. To reset the IMU, you must turn the ignition switch to the OFF position and back to the ON position before the engine can be restarted.

If a failure of the IMU is detected, the engine and fuel pump will not stop automatically when the vehicle falls over.

Assist-slipper Clutch System

CRF1100A/A4

The assist-slipper clutch system helps to prevent the rear tire from locking up when the deceleration of your vehicle produces a strong engine braking effect. It also makes the clutch lever operation feel lighter.

Use only MA classification engine oil for your vehicle. Using engine oil other than MA classification oil could result in damage to the assist-slipper clutch system.

Throttle by Wire System

This model is equipped with a Throttle by Wire System.

Do not put magnetized items or items susceptible to magnetic interference near the right handlebar switches.

Automatic Brightness Control and Background Control

Ambient brightness is detected by the photosensor.

Do not damage or cover the photosensor.

Otherwise, the automatic brightness control and background control may not work properly.

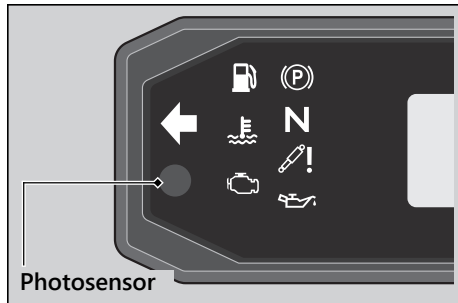

Caring for Your Vehicle

Frequent cleaning and polishing is important to ensure the life of your Honda. A clean vehicle makes it easier to spot potential problems. In particular, seawater and salts used to prevent ice on roads promote the formation of corrosion. Also, mud and dust may accelerate front suspension wear and cause oil leaks. Always wash your vehicle thoroughly after riding on coastal, treated, muddy or dusty roads.

Washing

Allow the engine, muffler, brakes, and other high-temperature parts to cool before washing.

1. Rinse your vehicle thoroughly using a low pressure garden hose to remove loose dirt.

Caring for Your Vehicle

2. If necessary, use a sponge or a soft towel with mild cleaner to remove road grime.
 - ▶ Clean the windshield, headlight lens, panels, and other plastic components with extra care to avoid scratching them. Avoid directing water into the air cleaner, muffler, and electrical parts.
3. Thoroughly rinse your vehicle with plenty of clean water and dry with a soft, clean cloth.
4. After the vehicle dries, lubricate any moving parts.
 - ▶ Make sure that no lubricant spills onto the brakes or tires. Brake discs, pads, drum or shoes contaminated with oil will suffer greatly reduced braking effectiveness and can lead to a crash.
5. Lubricate the drive chain immediately after washing and drying the vehicle.
6. Apply a coat of wax to prevent corrosion.
 - ▶ Avoid products that contain harsh detergents or chemical solvents. These can damage the metal, paint, and plastic on your vehicle.

Keep the wax clear of the tires and brakes.

- ▶ If your vehicle has any matte painted parts, do not apply a coat of wax to the matte painted surface.

Washing Precautions

Follow these guidelines when washing:

- Do not use high-pressure washers:
 - ▶ High-pressure water cleaners can damage moving parts and electrical parts, rendering them inoperable.
 - ▶ Water in the air intake can be drawn into the throttle body and/or enter the air cleaner.
 - Do not direct water at the muffler:
 - ▶ Water in the muffler can prevent starting and causes rust in the muffler.
 - Dry the brakes:
 - ▶ Water adversely affects braking effectiveness. After washing, apply the brakes intermittently at low speed to help dry them.
 - Do not direct water under the seat:
 - ▶ Water in the under seat compartment can damage your documents and other belongings.
-
- Do not direct water at the air cleaner:
 - ▶ Water in the air cleaner can prevent the engine from starting.
 - Do not direct water near the headlight:
 - ▶ The headlight's inside lens may fog temporarily after washing or while riding in the rain. This does not impact the headlight function.
However, if you see a large amount of water or ice accumulated inside the lens(es), have your vehicle inspected by your dealer.
 - Do not use wax or polishing compounds on matte painted surfaces:
 - ▶ Use a soft cloth or sponge, plenty of water, and a mild detergent to clean matte painted surfaces. Dry with a soft clean cloth.

Aluminum Components

Aluminum will corrode from contact with dirt, mud, or road salt. Clean aluminum parts regularly and follow these guidelines to avoid scratches:

- Do not use stiff brushes, steel wool, or cleaners containing abrasives.
- Avoid riding over or scraping against curbs.

Panels

Follow these guidelines to prevent scratches and blemishes:

- Wash gently using a soft sponge and plenty of water.
- To remove stubborn stains, use diluted detergent and rinse thoroughly with plenty of water.
- Avoid getting gasoline, brake fluid, or detergents on the instruments, panels, or headlight.

Windscreen

Using plenty of water, clean the windscreen with a soft cloth or sponge. (Avoid using detergents or any kind of chemical cleaner on the windscreen.) Dry with a soft, clean cloth.

NOTICE

To avoid possible scratching or other damage, use only water and a soft cloth or sponge to clean the windscreen.

For a dirtier windscreen, use a diluted neutral detergent with a sponge and plenty of water. Make sure to wash off all the detergent. (Detergent residue may cause windscreen cracks.)

Replace the windscreen if scratches cannot be removed and they obstruct clear vision.

Take care to keep battery electrolyte, brake fluid, or other chemical solvents off the windscreen and screen garnish. They will damage the plastic.

Exhaust Pipe and Muffler

The exhaust pipe and muffler are stainless steel but may become stained by mud or dust.

To remove mud or dust, use a wet sponge and a liquid kitchen abrasive, then rinse well with clean water. Dry with chamois or a soft towel.

If necessary, remove heat stains by using a commercially available fine texture compound. Then, rinse by the same manner as removing mud or dust.

If the exhaust pipe and muffler are painted, do not use a commercially available abrasive kitchen cleaning compound. Use a neutral detergent to clean the painted surface on the exhaust pipe and muffler. If you are not sure if your exhaust pipe and muffler are painted, contact your dealer.

NOTICE

Even though the exhaust is made of stainless steel, it can become stained. Remove all marks and blemishes as soon as they are noticed.

Storing Your Vehicle

If you store your vehicle outdoors, you should consider using a full-body cover.

If you won't be riding for an extended period, follow these guidelines:

- Wash your vehicle and wax all painted surfaces (except matte painted surfaces). Coat chrome pieces with rust-inhibiting oil.
- Lubricate the drive chain. ➤ P. 257
- Place your vehicle on a maintenance stand and position a block so that both tires are off the ground.
- After rain, remove the body cover and allow the vehicle to dry.
- Remove the battery (➤ P. 265) to prevent discharge. Fully charge the battery and then place it in a shaded, well-ventilated area.
 - ▶ If you leave the battery in place, disconnect the negative ⊖ terminal to prevent discharge.

After removing your vehicle from storage, inspect all maintenance items required by the Maintenance Schedule.

USA For more information about storage, refer to the *Honda Winter Storage Guide*, available from your dealer.

Canada For more information about storage, visit our website at www.honda.ca and look up “Storage Tips” under the “Honda Warranty” in the Warranty tab for your Model.

Transporting Your Vehicle

If your vehicle needs to be transported, it should be carried on a motorcycle trailer or a flatbed truck or trailer that has a loading ramp or lifting platform and motorcycle tie-down straps. Never try to tow your vehicle with a wheel or wheels on the ground.

NOTICE

Towing your vehicle with a wheel or wheels on the ground can cause serious damage to the transmission.

You & the Environment

Owning and riding a vehicle can be enjoyable, but you must do your part to protect the environment.

Choose Sensible Cleaners

Use a biodegradable detergent when you wash your vehicle. Avoid aerosol spray cleaners that contain chlorofluorocarbons (CFCs) which damage the atmosphere's protective ozone layer.

Recycle Wastes

Put oil and other toxic wastes in approved containers and take them to a recycling center. Call your local or state office of public works or environmental services to find a recycling center in your area and to get instructions on how to dispose of non-recyclable wastes. Do not place used engine oil in the trash or pour it down a drain or on the ground. Used oil, gasoline, coolant, and cleaning solvents contain poisons that can hurt refuse workers and contaminate drinking water, lakes, rivers, and oceans.

Vehicle Identification Number

The VIN and engine serial number uniquely identify your vehicle and are required in order to register your vehicle. They may also be required when ordering replacement parts. You should record these numbers and keep them in a safe place.

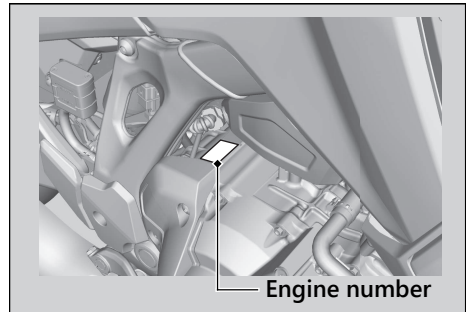
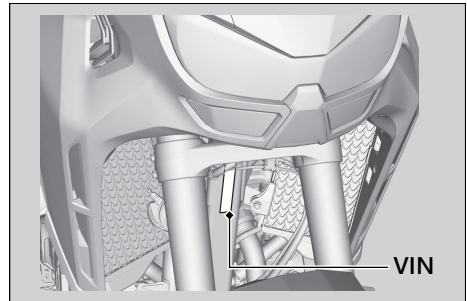
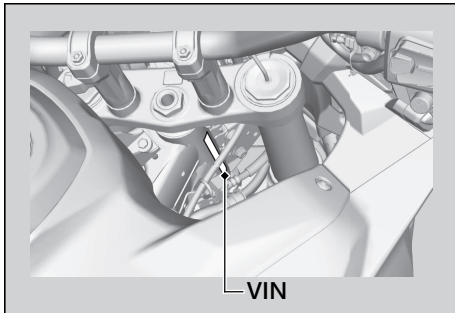

Emission Control Systems

Your vehicle engine emits combustion byproducts, including carbon monoxide (CO), oxides of nitrogen (NOx), and hydrocarbons (HC). Gasoline evaporation also emits hydrocarbons. Controlling the production of NOx, CO, and HC is important for the environment.

Exhaust Emission Requirements

The U.S. Environmental Protection Agency (EPA), the California Air Resources Board (CARB), and Environment and Climate Change Canada (ECCC) require that your vehicle comply with applicable exhaust, crankcase, and fuel permeation emission standards during its useful life, when operated and maintained according to the instructions provided.

CARB also requires that your vehicle comply with applicable evaporative emission requirements during its useful life, when operated and maintained according to the instructions provided.

USA Compliance with the terms of the Distributor's Warranties for Honda Motorcycle Emission Control Systems is necessary in order to maintain a valid emissions system warranty.

The Vehicle Emission Control Information label is located the rear fender under the front seat.

➔ P. 268

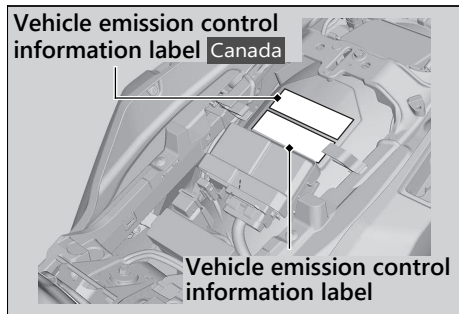

Noise Emission Requirements

The EPA requires that vehicles built after January 1, 1983 comply with applicable noise emission standards for one year or 3,730 miles (6,000 km) after the time of purchase when operated and maintained according to the instructions provided.

Exhaust Emission Control System

The exhaust emission control system includes the following components that should not need adjustment, although periodic inspection by your dealer is recommended.

PGM-FI System

The PGM-FI (programmed fuel injection) system uses sequential multiport fuel injection, and is comprised of air intake, engine control, fuel control, and exhaust control subsystems. The engine control module (ECM) uses sensors to determine how much air enters the engine, and then controls how much fuel to inject.

Ignition Timing Control System

The ignition timing control system adjusts the ignition timing to reduce the amount of HC, CO, and NO_x produced.

Secondary Air Injection System

The secondary air injection system adds filtered air into the exhaust gas to help improve emission control performance.

Catalytic Converters

The exhaust system contains one or more catalytic converters. Catalytic converters use a catalyst to convert most of the harmful exhaust gas compounds into harmless compounds.

Evaporative Emission Control System

50 STATE (meets California)

An evaporative emissions control system uses a canister filled with charcoal to adsorb fuel vapor from the fuel tank while the engine is off. The vapor is drawn into the engine and burned while riding.

Crankcase Emissions Control System

The engine is equipped with a closed crankcase system to prevent discharging crankcase emissions into the atmosphere.

Blow-by gas is returned to the combustion chamber through the air cleaner and throttle body.

Fuel Permeation Emission Control

The fuel tank, fuel hoses, and fuel vapor charge hoses use fuel permeation control technologies to prevent fuel vapor emissions. Tampering with these components to reduce or defeat the effectiveness of the fuel permeation technologies is prohibited.

Noise Emission Control System

TAMPERING WITH THE NOISE CONTROL SYSTEM IS PROHIBITED:

U. S. federal law prohibits, and Canadian provincial laws may prohibit, the following acts or the causing thereof: (1) The removal or rendering inoperative by any person, other than for purposes of maintenance, repair or replacement, of any device or element of design incorporated into any new vehicle for the purpose of noise control prior to its sale or delivery to the ultimate purchaser or while it is in use; or (2) the use of the vehicle after such device or element of design has been removed or rendered inoperative by any person.

AMONG THOSE ACTS PRESUMED TO CONSTITUTE TAMPERING ARE THE FOLLOWING ACTS:

- Removal of, or puncturing the muffler, baffles, header pipes or any other component which conducts exhaust gases.
- Removal of, or puncturing of any part of the intake system.
- Lack of proper maintenance.
- Removing or disabling any emissions compliance component, or replacing any compliance component with a noncompliant component.

Problems Affecting Vehicle Exhaust Emissions

Have your vehicle inspected and repaired by your dealer if you experience any of the following symptoms:

- Hard starting or stalling after starting
- Rough idling
- Misfiring or backfiring during acceleration
- Poor engine performance and poor fuel economy

Catalytic Converter

This vehicle is equipped with a three-way catalytic converter. The catalytic converter contains precious metals that serve as catalysts in high temperature chemical reactions that convert hydrocarbons (HC), carbon monoxide (CO), and oxides of nitrogen (NOx) in the exhaust gases into safe compounds.

A defective catalytic converter contributes to air pollution and can impair your engine's performance. A replacement unit must be an original Honda part or equivalent.

Follow these guidelines to protect your vehicle's catalytic converter:

- Always use unleaded gasoline. Leaded gasoline will damage the catalytic converter.
- Keep the engine in good running condition. A poorly running engine can cause the catalytic converter to overheat, causing damage to the converter or the vehicle.
- If your engine is misfiring, backfiring, stalling, or otherwise not running properly, stop riding and turn off the engine. Have your vehicle serviced as soon as possible.

Oxygenated Fuels

Some conventional fuels blended with alcohol or an ether compound are available in some locales to help reduce emissions to meet clean air standards. These gasolines are collectively referred to as oxygenated fuels. If you plan to use oxygenated fuel, check that it is unleaded and meets the minimum octane rating and blend requirement.

The following fuel blends have been approved for use in your vehicle:

- Ethanol (ethyl alcohol) up to 10% by volume.
 - ▶ Gasoline containing ethanol may be marketed under the name Gasohol.
- Do not use gasoline containing methanol (methyl alcohol).

If you accidentally fill your fuel tank with an oxygenated fuel containing higher percentages, you may experience performance problems. To resolve the problem, have your dealer drain the fuel tank and replace with the correct fuel. Fuel

system or performance problems resulting from the use of an oxygenated fuel containing higher percentages are not covered by your warranty.

NOTICE

Improper use of oxygenated fuels can damage metal, rubber, and plastic parts of your fuel system.

Oxygenated fuel can also damage paint.

Damage caused by spilled fuel is not covered by warranty.

If you notice any undesirable operating symptoms or performance problems, try a different brand of gasoline.

Authorized Manuals

USA The Service Manual used by your authorized dealer is available from your Honda dealer or Helm, Inc.

Canada See your dealer to order authorized manuals.

Also available, but not necessary to service your model, is the Honda Common Service Manual, which explains basic service information for various systems on Honda motorcycles, scooters, ATV, and SxS.

USA The Winter Storage Guide in conjunction with the Owner's Manual and Service Manual can help you prepare your Honda motorcycle, scooter, ATV, and SxS for winter storage.

These Honda manuals are written for the professional technician. However, if you possess the proper tools, observe the safety standards, and are mechanically capable, you should find them easy to use.

Special Honda tools are necessary for some procedures.

USA

Order online: www.helminc.com

Order Toll Free: 1-888-CYCLE93

(1-888-292-5393)

(NOTE: For Credit Card Orders Only)

Monday - Friday 8:00 AM - 6:00 PM ET

Description
2025 Africa Twin Service Manual
Common Service Manual (61CSM00)
USA Winter Storage Guide (S9507)
2025 Africa Twin Owner's Manual

Warranty Coverage and Service

Coverage

Your new Honda is covered by the following warranties:

- Vehicle Limited Warranty
- Emission Control System Warranty
- **USA** Noise Control Warranty

The responsibilities, restrictions, and exclusions that apply to these warranties are explained in the Warranties Booklet given to you by your Honda dealer at the time of purchase. Always keep your Honda owner's card with your Warranties Booklet.

Canada Please refer to the Warranty Booklet posted on our website at www.honda.ca.

It is important to realize that your warranty applies only to defects in material or workmanship of your Honda. Your warranty coverage does not apply to the normal wear and deterioration associated with use of the vehicle.

Your warranty coverage is not voided if you perform your own maintenance. However, failures that occur due directly to improper maintenance are not covered by these warranties.

USA You can extend almost all of your warranty coverage through the HondaCare® Protection Plan. For more information, see your Honda dealer.

Statement on Warranty Coverage for Aftermarket and Recycled Parts

The Magnuson-Moss Warranty Act, 15 U.S.C. s. 2301 et seq., makes it illegal for motor vehicle manufacturers to void a motor vehicle warranty or deny warranty coverage solely because an aftermarket or recycled part has been used to repair the vehicle or someone other than the authorized service provider performed service on the vehicle. This provision does not apply to a new motor vehicle purchased solely for commercial or industrial use.

Under federal law, a manufacturer may deny warranty coverage and charge for repairs to a vehicle if it is discovered that an aftermarket or recycled part installed on the vehicle is defective or was installed incorrectly and caused damage to another part of the vehicle otherwise covered under warranty. The Federal Trade Commission requires that a manufacturer demonstrate that an aftermarket or recycled part or service performed by a person other than an

authorized service provider caused damage to another part of the vehicle otherwise covered under warranty before denying warranty coverage. Additionally, federal law allows a manufacturer to void a motor vehicle warranty or deny warranty coverage if the manufacturer provides the article or service to consumers free of charge under the warranty or the manufacturer has secured a waiver from the Federal Trade Commission.

Service

Please remember that maintenance recommended in the Maintenance Schedule is not included in your warranty coverage.

If you believe you have a problem with your vehicle, call the service department of your Honda dealer. Make an appointment for an inspection and diagnosis. You will be asked to authorize that inspection, and your dealer will return the results of the inspection. If a problem exists and is covered under warranty, your dealer will perform the warranty repairs. If you have any questions about your warranty coverage or the nature of the repair, talk to the Service Manager of your Honda dealer.

If a misunderstanding occurs and you aren't satisfied with your dealer's handling of the situation, we suggest you discuss your problem with the appropriate member of the dealership's management team. If you are still not satisfied, contact the owner of the dealership or their designated representative.

Honda Contacts

American Honda Motor Co., Inc.

If you wish to contact Honda directly to comment on your experiences with your vehicle or with your dealer, please send your comments using one of the following methods:



POST MAIL

Powersports Customer Relations
American Honda Motor Co., Inc.
4900 Marconi Drive
Alpharetta, GA 30005-8847



PHONE

Telephone: (866) 784-1870



ONLINE CUSTOMER SERVICE

Website: <https://powersports.honda.com/contact-us>

Canada

Honda Canada Inc.
Customer Relations Department,
180 Honda Boulevard
Markham, Ontario
L6C 0H9

Telephone: (888) 946-6329

Fax: (877) 939-0909

E-mail: honda_cr@ch.honda.com

Please include the following information in your letter:

- Name, address, and telephone number
- Product model, year, and VIN
- Date of purchase
- Dealer name and address

We will likely ask your Honda dealer to respond, or possibly acknowledge your comments directly.

Your Honda Dealer

The service department of your Honda dealer offers trained personnel to perform regular maintenance and unexpected repairs. It has the latest available service information from Honda and also handles warranty inspections and repairs.

The parts department offers Honda Genuine Parts, Pro Honda products, Honda Accessories (USA only), and Honda accessories and products (Canada only) that provide the same quality that went into your vehicle.

USA The sales department offers the HondaCare® Protection Plan to extend almost all of your warranty coverage.

Your Honda dealer can also supply information about riding events and information about safety training available in your local area.

Reporting Safety Defects

USA

If you believe that your vehicle has a defect which could cause a crash or could cause injury or death, you should immediately inform the National Highway Traffic Safety Administration (NHTSA) in addition to notifying American Honda Motor Co., Inc.

If NHTSA receives similar complaints, it may open an investigation, and if it finds that a safety defect exists in a group of vehicles, it may order a recall and remedy campaign. However, NHTSA cannot become involved in individual problems between you, your

dealer, or American Honda Motor Co., Inc.

To contact NHTSA, you may call the Vehicle Safety Hotline toll-free at: 1-888-327-4236

(TTY: 1-800-424-9153); go to

<https://www.safercar.gov>;

or write to:

Administrator, NHTSA,
1200 New Jersey Avenue, SE.,
Washington, DC 20590.

You can also obtain other information about motor vehicle safety from:

<https://www.safercar.gov>.

Canada

If you believe that your vehicle has a defect which could cause a crash or could cause injury or death, you should immediately inform Honda Canada Inc. and you may also inform Transport Canada.

If Transport Canada receives similar complaints, it may open an investigation, and if it finds that a safety defect exists in a group of vehicles, it may lead to a recall and remedy campaign. However, Transport Canada cannot become involved in individual problems between you, your dealer, or Honda Canada Inc.

To contact Transport Canada's Defect Investigations and Recalls Division,

Mailing Address:
Transport Canada - ASFAD
330 Sparks Street
Ottawa, ON
K1A 0N5

Telephone: 819-994-3328 (Ottawa-Gatineau area or internationally)
Toll free: 1-800-333-0510 (in Canada)

Online:
(English Link:) www.tc.canada.ca/recalls
(French Link:) www.tc.canada.ca/rappels

For more information on reporting safety defects or about motor vehicle safety, go to
<https://www.tc.gc.ca/roadsafety>.

Legal Information on Apple CarPlay/Android Auto™

OWNER'S MANUAL LICENSE/LIABILITY STATEMENTS

USE OF APPLE CARPLAY IS SUBJECT TO YOUR AGREEMENT TO THE CARPLAY TERMS OF USE, WHICH ARE INCLUDED AS PART OF THE APPLE iOS TERMS OF USE. IN SUMMARY, THE CARPLAY TERMS OF USE DISCLAIM APPLE AND ITS SERVICE PROVIDERS' LIABILITY IF THE SERVICES FAIL TO PERFORM CORRECTLY OR ARE DISCONTINUED, STRICTLY LIMIT APPLE AND ITS SERVICE PROVIDERS' OTHER LIABILITIES, DESCRIBE THE KINDS OF USER INFORMATION (INCLUDING, FOR EXAMPLE, VEHICLE LOCATION, VEHICLE SPEED, AND VEHICLE STATUS) BEING GATHERED AND STORED BY APPLE AND ITS SERVICE PROVIDERS, AND DISCLOSE CERTAIN POSSIBLE RISKS ASSOCIATED WITH THE USE

OF CARPLAY, INCLUDING THE POTENTIAL FOR DRIVER DISTRACTION.

SEE APPLE'S PRIVACY POLICY FOR DETAILS REGARDING APPLE'S USE AND HANDLING OF DATA UPLOADED BY CARPLAY.

USE OF **ANDROID AUTO™** IS SUBJECT TO YOUR AGREEMENT TO THE **ANDROID AUTO™** TERMS OF USE WHICH MUST BE AGREED TO WHEN THE **ANDROID AUTO™** APPLICATION IS DOWNLOADED TO YOUR **ANDROID™** PHONE. IN SUMMARY, THE **ANDROID AUTO™** TERMS OF USE DISCLAIM **GOOGLE™** AND ITS SERVICE PROVIDERS' LIABILITY IF THE SERVICES FAIL TO PERFORM CORRECTLY OR ARE DISCONTINUED, STRICTLY LIMIT **GOOGLE™** AND ITS SERVICE PROVIDERS' OTHER LIABILITIES, DESCRIBE THE KINDS OF USER INFORMATION (INCLUDING, FOR EXAMPLE, VEHICLE LOCATION, VEHICLE SPEED, AND VEHICLE STATUS) BEING GATHERED AND STORED BY **GOOGLE™** AND ITS SERVICE PROVIDERS, AND DISCLOSE CERTAIN POSSIBLE RISKS ASSOCIATED WITH THE USE OF **ANDROID AUTO™**, INCLUDING THE POTENTIAL FOR DRIVER DISTRACTION.

SEE **GOOGLE™**'S PRIVACY POLICY FOR DETAILS REGARDING **GOOGLE™**'S USE AND

HANDLING OF DATA UPLOADED BY **ANDROID AUTO™**.

**DISCLAIMER OF WARRANTIES;
LIMITATION ON LIABILITY**

YOU EXPRESSLY ACKNOWLEDGE AND AGREE THAT USE OF APPLE CARPLAY OR **ANDROID AUTO™** ("THE APPLICATIONS") IS AT YOUR SOLE RISK AND THAT THE ENTIRE RISK AS TO SATISFACTORY QUALITY, PERFORMANCE, ACCURACY AND EFFORT IS WITH YOU TO THE MAXIMUM EXTENT PERMITTED BY APPLICABLE LAW, AND THAT THE APPLICATIONS AND INFORMATION ON THE APPLICATIONS IS PROVIDED "AS IS" AND "AS AVAILABLE," WITH ALL FAULTS AND WITHOUT WARRANTY OF ANY KIND, AND HONDA HEREBY DISCLAIMS ALL WARRANTIES AND CONDITIONS WITH RESPECT TO THE APPLICATIONS AND INFORMATION ON THE APPLICATIONS, EITHER EXPRESS, IMPLIED OR STATUTORY, INCLUDING, BUT NOT LIMITED TO, THE IMPLIED WARRANTIES AND/OR CONDITIONS OF MERCHANTABILITY, SATISFACTORY QUALITY, FITNESS FOR A PARTICULAR

PURPOSE, ACCURACY, QUIET ENJOYMENT, AND NONINFRINGEMENT OF THIRD PARTY RIGHTS. NO ORAL OR WRITTEN INFORMATION OR ADVICE GIVEN BY HONDA OR AN AUTHORIZED REPRESENTATIVE SHALL CREATE A WARRANTY. AS EXAMPLES, AND WITHOUT LIMITATION, HONDA DISCLAIMS ANY WARRANTY REGARDING THE ACCURACY OF DATA PROVIDED BY THE APPLICATIONS, SUCH AS THE ACCURACY OF DIRECTIONS, ESTIMATED TRAVEL TIME, SPEED LIMITS, ROAD CONDITIONS, NEWS, WEATHER, TRAFFIC, OR OTHER CONTENT PROVIDED BY APPLE, **GOOGLE™**, THEIR AFFILIATES, OR THIRD PARTY PROVIDERS; HONDA DOES NOT GUARANTEE AGAINST LOSS OF APPLICATION DATA, WHICH MAY BE LOST AT ANY TIME; HONDA DOES NOT GUARANTEE THAT THE APPLICATIONS OR ANY SERVICES PROVIDED THROUGH THEM WILL BE PROVIDED AT ALL TIMES OR THAT ANY OR ALL SERVICES WILL BE AVAILABLE AT ANY PARTICULAR TIME OR LOCATION.

FOR EXAMPLE, SERVICES MAY BE SUSPENDED OR INTERRUPTED WITHOUT NOTICE FOR REPAIR, MAINTENANCE, SECURITY FIXES, UPDATES, ETC., SERVICES MAY BE UNAVAILABLE IN YOUR AREA OR LOCATION, ETC. IN ADDITION, YOU UNDERSTAND THAT CHANGES IN THIRD PARTY TECHNOLOGY OR GOVERNMENT REGULATION MAY RENDER THE SERVICES AND/OR APPLICATIONS OBSOLETE AND/OR UNUSABLE.

TO THE EXTENT NOT PROHIBITED BY LAW, IN NO EVENT SHALL HONDA OR ITS AFFILIATES BE LIABLE FOR PERSONAL INJURY, OR ANY INCIDENTAL, SPECIAL, INDIRECT OR CONSEQUENTIAL DAMAGES WHATSOEVER, INCLUDING, WITHOUT LIMITATION, DAMAGES FOR LOSS OF PROFITS, CORRUPTION OR LOSS OF DATA, FAILURE TO TRANSMIT OR RECEIVE ANY DATA, BUSINESS INTERRUPTION OR ANY OTHER COMMERCIAL DAMAGES OR LOSSES, ARISING OUT OF OR RELATED TO THE APPLICATIONS OR YOUR USE OF OR INABILITY

TO USE THE APPLICATIONS OR INFORMATION ON THE APPLICATIONS, HOWEVER CAUSED, REGARDLESS OF THE THEORY OF LIABILITY (CONTRACT, TORT OR OTHERWISE) AND EVEN IF HONDA WERE ADVISED OF THE POSSIBILITY OF SUCH DAMAGES. SOME REGIONS AND JURISDICTIONS MAY DISALLOW THE EXCLUSION OR LIMITATION OF LIABILITY FOR DAMAGES, SO THESE LIMITATIONS AND EXCLUSIONS MAY NOT APPLY TO YOU. THE FOREGOING LIMITATIONS WILL APPLY EVEN IF THE ABOVE STATED REMEDY FAILS OF ITS ESSENTIAL PURPOSE.

Software Upgrades

Upgrades

Honda is continually expanding the scope of the system software. The softwares are updated to correspond with new version releases.

For software updates, contact your dealer.

Specifications

■ Main Components

Overall length	CRF1100A/D	91.7 in (2,330 mm)
	CRF1100A4/D4	90.7 in (2,305 mm)
Overall width		37.8 in (960 mm)
Overall height	CRF1100A/D	Highest position
		60.6 in (1,540 mm)
		Lowest position
		58.5 in (1,485 mm)
	CRF1100A4/D4	Highest position
		60.2 in (1,530 mm)
		Lowest position
		58.1 in (1,475 mm)
Wheelbase	CRF1100A/D	62.0 in (1,575 mm)
	CRF1100A4/D4	61.8 in (1,570 mm)
Minimum ground clearance	CRF1100A/D	9.8 in (250 mm)
	CRF1100A4/D4	8.7 in (220 mm)
Caster angle		27° 30'

Trail	CRF1100A/D	4.4 in (113 mm)
	CRF1100A4/D4	4.2 in (106 mm)
Curb weight	CRF1100A	509 lb (231 kg)
	CRF1100D	534 lb (242 kg)
	CRF1100A4	536 lb (243 kg)
	CRF1100D4	558 lb (253 kg)
Maximum weight capacity *1		450 lb (204 kg)
Maximum weight on rear carrier		22 lb (10 kg)
Passenger capacity		Rider and 1 passenger
Minimum turning radius		8.5 ft (2.60 m)
Displacement		66.1 cu-in (1,084 cm ³)
Bore x stroke		3.62 x 3.21 in (92.0 x 81.5 mm)
Compression ratio		10.5:1
Fuel		Unleaded gasoline
		Recommended: 86 PON or higher
Tank capacity	CRF1100A/D	4.97 US gal (18.8 L)
	CRF1100A4/D4	6.55 US gal (24.8 L)

*1 : Including rider, passenger, all luggage, and accessories

Specifications

Battery	HJ13L
	12 V-6 Ah (20 HR)
	CRF1100A/A4
	1st 2.866
	2nd 1.888
	3rd 1.480
	4th 1.230
Gear ratio	5th 1.064
	6th 0.972
	CRF1100D/D4
	1st 2.562
	2nd 1.761
	3rd 1.375
	4th 1.133
Reduction ratio (primary / final)	5th 0.972
	6th 0.882
	CRF1100A/A4 1.717 / 2.625
	CRF1100D/D4 1.863 / 2.625

■ Service Data

Tire size	Front	CRF1100A/D 90/90-21M/C 54H
	Rear	CRF1100A4/D4 110/80R19M/C 59V
Tire type	Front	CRF1100A/D Bias-ply, tubeless
	Rear	CRF1100A4/D4 Radial, tubeless

Recommended Tire	Front	CRF1100A/D MICHELIN ANAKEE ADVENTURE
		CRF1100A4/D4 BRIDGESTONE BATTLAX ADVENTURE A41F N
	Rear	CRF1100A/D MICHELIN ANAKEE ADVENTURE
		CRF1100A4/D4 BRIDGESTONE BATTLAX ADVENTURE A41R N
Tire air pressure (Up to 90 kg (200 lbs) load)	Front	33 psi (225 kPa, 2.25 kgf/cm ²)
	Rear	36 psi (250 kPa, 2.50 kgf/cm ²)
Tire air pressure (Up to maximum weight capacity)	Front	33 psi (225 kPa, 2.25 kgf/cm ²)
	Rear	41 psi (280 kPa, 2.80 kgf/cm ²)
Minimum tread depth	Front	0.06 in (1.5 mm)
	Rear	0.08 in (2.0 mm)

Spark plug	(standard)	SILMAR8A9S (NGK)
Spark plug gap	(non-adjustable)	0.03 - 0.04 in (0.8 - 0.9 mm)
Idle speed	(non-adjustable)	1,250 ± 100 rpm
Recommended engine oil	API Service Classification SJ or higher except oils labeled as energy conserving or resource conserving on the circular API service label, SAE 10W-30, JASO T 903 standard MA, Pro Honda GN4 4-stroke oil (USA & Canada) or Honda 4-stroke oil, or an equivalent motorcycle oil	
Engine oil capacity	CRF1100A/A4	
	After draining	4.1 US qt (3.9 L)
	After draining & engine oil filter change	4.2 US qt (4.0 L)
	After disassembly	5.1 US qt (4.8 L)
	CRF1100D/D4	
	After draining	4.2 US qt (4.0 L)
After draining & engine oil filter change	4.4 US qt (4.2 L)	
After draining, engine & clutch oil filter change	4.4 US qt (4.2 L)	
After disassembly	5.5 US qt (5.2 L)	

Specifications

Recommended brake fluid	Honda DOT 4 Brake Fluid	
Cooling system capacity	1.91 US qt (1.81 L)	
Recommended coolant	Pro Honda HP Coolant	
Recommended drive chain lubricant	Pro Honda HP Chain Lube or equivalent	
Drive chain slack	1 7/8 - 2 1/16 in (48 - 53 mm)	
Standard drive chain	DID 525HV3	
	No. of links	124
Standard sprocket size	Drive sprocket	16T
	Driven sprocket	42T

■ Bulbs

Headlight	LED
CRF1100A4/D4	LED
Cornering light	LED
Brake light/Taillight	LED
Front turn signal/Position light	LED
Rear turn signal	LED
License plate light	LED

■ Fuses

Main fuse	30 A
Other fuse	30 A, 20 A, 15 A, 10 A

■ Torque Specifications

Spark arrester mounting bolt	6.6 lbf-ft (9.0 N·m, 0.9 kgf·m)
Tail cap mounting bolt	6.6 lbf-ft (9.0 N·m, 0.9 kgf·m)

Information Record

VIN	
Engine No.	
Color Label & Code	
Owner's Name	
Address	
City/State	
Phone	
Dealer's Name	
Address	
City/State	
Phone	
Service Manager	

California Proposition 65 Warning

 **WARNING:** Operating, servicing and maintaining a passenger vehicle or off-highway motor vehicle can expose you to chemicals including engine exhaust, carbon monoxide, phthalates, and lead, which are known to the State of California to cause cancer and birth defects or other reproductive harm. To minimize exposure, avoid breathing exhaust, do not idle the engine except as necessary, service your vehicle in a well-ventilated area and wear gloves or wash your hands frequently when servicing your vehicle. For more information go to www.P65Warnings.ca.gov/passenger-vehicle.



31MLN810
00X31-MLN-8100

© 2024 Honda Motor Co., Ltd.
All Rights Reserved

Printed in Japan