

OWNER'S MANUAL

2025 REBEL 1100

This manual should be considered a permanent part of the vehicle and should remain with the vehicle when it is resold.

This publication includes the latest production information available before printing. Honda Motor Co., Ltd. reserves the right to make changes at any time without notice and without incurring any obligation.

No part of this publication may be reproduced without written permission.

The vehicle pictured in this owner's manual may not match your actual vehicle.

CMX1100A/A2/D/D2/D3 Single seat type is USA model only.

CMX1100A/A2/D/D2 Double seat type is Canada model only.

Welcome

Congratulations on your purchase of a new Honda vehicle. Your selection of a Honda makes you part of a worldwide family of satisfied customers who appreciate Honda's reputation for building quality into every product.

To ensure your safety and riding pleasure:

- Read this owner's manual carefully.
- Follow all recommendations and procedures contained in this manual.
- Pay close attention to safety messages contained in this manual and on the vehicle.

To protect your investment, we urge you to take responsibility for keeping your vehicle well-serviced and maintained. Also, observe the break-in guidelines and always perform the pre-ride inspection and other periodic checks in this manual.

When service is required, remember that your Honda dealer knows your vehicle best. If you have the required mechanical "know-how" and tools, you can purchase an official Honda Service Manual to help you perform many maintenance and repair tasks. ➔ P. 201

Read the warranty information thoroughly so that you understand the warranty coverage and are aware of your rights and responsibilities. ➔ P. 202

You may also want to visit our website at www.powersports.honda.com.

Canada www.honda.ca.

Happy riding!

A Few Words About Safety

Your safety, and the safety of others, is very important. Operating this vehicle safely is an important responsibility.

To help you make informed decisions about safety, we have provided operating procedures and other information on safety labels and in this manual. This information alerts you to potential hazards that could hurt you or others.

Of course, it is not practical or possible to warn you about all hazards associated with operating or maintaining a vehicle. You must use your own good judgment.

You will find important safety information in a variety of forms, including:

- Safety labels on the vehicle
- Safety Messages preceded by a safety alert symbol  and one of three signal words: DANGER, WARNING, or CAUTION. These signal words mean:

DANGER

You **WILL** be **KILLED** or **SERIOUSLY HURT** if you don't follow instructions.

WARNING

You **CAN** be **KILLED** or **SERIOUSLY HURT** if you don't follow instructions.

CAUTION

You **CAN** be **HURT** if you don't follow instructions.

Other important information is provided under the following titles:

NOTICE

Information to help you avoid damage to your vehicle, other property, or the environment.

Contents

Vehicle Safety P. 2

Operation Guide P. 22

Maintenance P. 122

Troubleshooting P. 166

Information P. 181

Specifications P. 209

Vehicle Safety

This section contains important information for safe riding of your vehicle.
Please read this section carefully.

Safety Guidelines	P. 3
Safety Labels	P. 8
Safety Precautions	P. 10
Riding Precautions	P. 12
Accessories & Modifications	P. 17
Loading	P. 18

Safety Guidelines

Follow these guidelines to enhance your safety:

- Perform all routine and regular inspections specified in this manual.
- Stop the engine and keep sparks and flames away before filling the fuel tank.
- Do not run the engine in enclosed or partly enclosed areas. Carbon monoxide in exhaust gases is toxic and can kill you.

Always Wear a Helmet

It's a proven fact: helmets and protective apparel significantly reduce the number and severity of head and other injuries. So always wear an approved helmet and protective apparel. ➤ P. 10

Before Riding

USA model (Model not equipped with Optional Passenger Seat Kit)

Make sure that you are physically fit, mentally focused, and free of alcohol and drugs. Check that you are wearing an approved helmet and protective apparel.

Canada model and USA model equipped with Optional Passenger Seat Kit

Make sure that you are physically fit, mentally focused, and free of alcohol and drugs. Check that you and your passenger are both wearing an approved helmet and protective apparel. Instruct your passenger on holding onto the seat strap or your waist, leaning with you in turns, and keeping their feet on the footpegs, even when the vehicle is stopped.

Take Time to Learn & Practice

Even if you have ridden other vehicles, practice riding in a safe area to become familiar with how this vehicle works and handles, and to become accustomed to the vehicle's size and weight.

We recommend that all riders take a certified course approved by the Motorcycle Safety Foundation (MSF) or a state approved training course. New riders should start with the basic course, and even experienced riders will find the advanced course beneficial.

For information about the MSF training course nearest you, call the national toll-free number: (800) 446-9227.

USA Other riding tips can be found in the You and Your Motorcycle Riding Tips booklet that came with your vehicle.

Ride Defensively

Always pay attention to other vehicles around you, and do not assume that other drivers see you. Be prepared to stop quickly or perform an evasive maneuver.

Make Yourself Easy to See

Make yourself more visible, especially at night, by wearing bright reflective clothing, positioning yourself so other drivers can see you, signaling before turning or changing lanes, and using your horn when necessary.

Ride within Your Limits

Never ride beyond your personal abilities or faster than conditions warrant. Fatigue and inattention can impair your ability to use good judgment and ride safely.

Never Carry a passenger

USA model (Model not equipped with Optional Passenger Seat Kit)

There are no handholds, seat, or footrests to carry a passenger.

Do not carry a passenger unless you have purchased and installed the Honda Accessory Passenger Seat Kit, or equivalent parts specifically designed for this vehicle, which must include the passenger seat, seat strap, footpegs, and the mounting hardware.

Don't Drink or Use Drugs and Ride

Alcohol or drugs and riding don't mix. Even one alcoholic drink can reduce your ability to respond to changing conditions, and your reaction time gets worse with every additional drink. The same is true for drug use. Don't drink or use and ride, and don't let your friends do it either.

Keep Your Honda in Safe Condition

It's important to keep your vehicle properly maintained and in safe riding condition. Inspect your vehicle before every ride and perform all recommended maintenance. Never exceed load limits (➤ P. 18), and do not modify your vehicle or install accessories that would make your vehicle unsafe (➤ P. 17).

If You are Involved in a Crash

Personal safety is your first priority. If you or anyone else has been injured, take time to assess the severity of the injuries and whether it is safe to continue riding. Call for emergency assistance if needed. Also follow applicable laws and regulations if another person or vehicle is involved in the crash.

Safety Guidelines

If you decide to continue riding, first turn the ignition switch to the OFF position, and evaluate the condition of your vehicle. Inspect for fluid leaks, check the tightness of critical nuts and bolts, and check the handlebar, control levers, brakes, and wheels. Ride slowly and cautiously. Your vehicle may have suffered damage that is not immediately apparent. Have your vehicle thoroughly checked at a qualified service facility as soon as possible.

Emergency Shut-down Procedure for Vehicles Equipped with Dual Clutch Transmission

CMX1100D/D2/D3

Unlike standard Vehicles, or its manual transmission sibling, the CMX1100D/D2/D3 with dual-clutch transmission does not have a clutch lever that would provide you with an additional means to control the engine power being transmitted to the rear wheel. Thus, in the unlikely event that you experience a stuck throttle or other unintended application of power to the rear wheel, you should shut down the engine by use of the engine stop switch (P. 84). By moving this switch to the  (Stop) position, you will immediately stop the engine but maintain all electrical system functions, including lights and indicators.

Carbon Monoxide Hazard

Exhaust contains poisonous carbon monoxide, a colorless, odorless gas. Breathing carbon monoxide can cause loss of consciousness and may lead to death.

If you run the engine in a confined or even partly enclosed area, the air you breathe could contain a dangerous amount of carbon monoxide.

Never run your vehicle inside a garage or other enclosure.

WARNING

Running the engine of your vehicle while in an enclosed or even partially enclosed area can cause a rapid build-up of toxic carbon monoxide gas.

Breathing this colorless, odorless gas can quickly cause unconsciousness and lead to death.

Only run your vehicle's engine when it is located in a well ventilated area outdoors.

Safety Labels

Safety and information labels on your vehicle provide important safety information and may warn you of potential hazards that could cause

serious injury. Read these labels carefully and don't remove them.

If a label comes off or becomes hard to read, contact your dealer for a replacement.

USA model (Model not equipped with Optional Passenger Seat Kit) shown

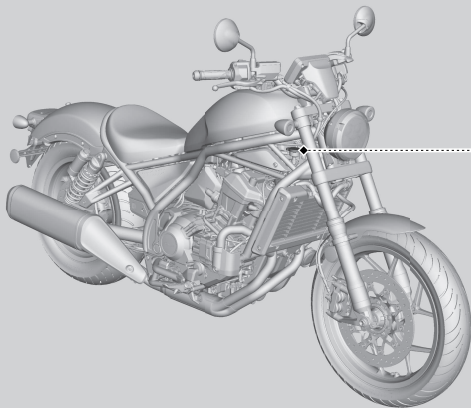

USA model (Model not equipped with Optional Passenger Seat Kit) shown

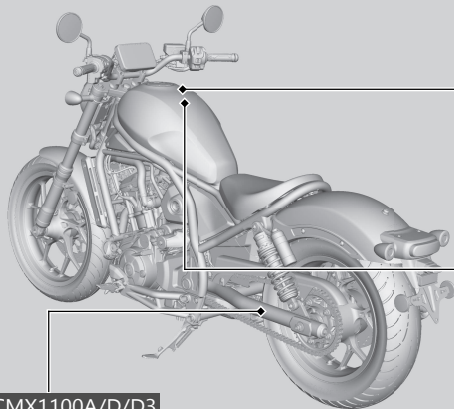

⚠ WARNING

Improper loading can cause a crash and you may be seriously hurt or killed. See "Load Limits and Guidelines" in your Owner's Manual for complete instructions.

For your protection, always wear your helmet while riding. Read the owner's manual carefully.

CMX1100A/D/D3

TIRE INFORMATION			
Cold tire pressures		kPa	kg/cm ² psi
Up to maximum weight capacity	Front	225	2.25 33
	Rear	225	2.25 33
Up to 90kg(200lbs) load	Front	225	2.25 33
	Rear	225	2.25 33
	Front	130/70B 18M/C 63H	
Tire size	Rear	180/65B 16M/C 61H	
Minimum recommend tire center tread depth.	Front	1.5mm (0.06in.)	
	Rear	2.0mm (0.08in.)	
Maximum weight capacity		156kg(343lbs)	

DRIVE CHAIN
Keep chain adjusted and lubricated. 20 mm (3/4 in.) Freeplay

Read owner's manual.

CMX1100A2/D2

TIRE INFORMATION			
Cold tire pressures		kPa	kg/cm ² psi
Up to maximum weight capacity	Front	225	2.25 33
	Rear	225	2.25 33
Up to 90kg(200lbs) load	Front	225	2.25 33
	Rear	225	2.25 33
	Front	130/70B 18M/C 63H	
Tire size	Rear	180/65B 16M/C 61H	
Minimum recommend tire center tread depth.	Front	1.5mm (0.06in.)	
	Rear	2.0mm (0.08in.)	
Maximum weight capacity		149kg(328lbs)	

DRIVE CHAIN
Keep chain adjusted and lubricated. 20 mm (3/4 in.) Freeplay

Read owner's manual.

Safety Precautions

- Ride cautiously and keep your hands on the handlebar and feet on the footpegs.
- **Canada model and USA model equipped with Optional Passenger Seat Kit**
Instruct your passenger to keep their hands on the seat strap or your waist and their feet on the footpegs while riding.
- **USA model (Model not equipped with Optional Passenger Seat Kit)**
Always consider the safety of other drivers and riders.
- **Canada model and USA model equipped with Optional Passenger Seat Kit**
Always consider the safety of your passenger, as well as other drivers and riders.

Protective Apparel

USA model (Model not equipped with Optional Passenger Seat Kit)

Make sure that you are wearing an approved helmet, eye protection, and high-visibility protective clothing. Avoid wearing loose clothes that could get caught on any part of the vehicle. Ride defensively in response to weather and road conditions.

Canada model and USA model equipped with Optional Passenger Seat Kit

Make sure that you and any passenger are wearing an approved helmet, eye protection, and high-visibility protective clothing. Avoid wearing loose clothes that could get caught on any part of the vehicle. Ride defensively in response to weather and road conditions.

■ Helmet

Should be safety-standard certified, high-visibility, and the correct size for your head.

- Must fit comfortably but securely, with the chin strap fastened
- Face shield with unobstructed field of vision or other approved eye protection

USA Look for a DOT (Department of Transportation) certification label on any helmet you buy.

WARNING

Not wearing a helmet increases the chance of serious injury or death in a crash.

USA model (Model not equipped with Optional Passenger Seat Kit)

Make sure that you always wear an approved helmet and protective apparel.

Canada model and USA model equipped with Optional Passenger Seat Kit

Make sure that you and any passenger always wear an approved helmet and protective apparel.

Riding Precautions

■ Gloves

Full-finger leather gloves with high abrasion resistance

■ Boots or Riding Shoes

Sturdy boots with non-slip soles and ankle protection

■ Jacket and Pants

Protective, highly visible, long-sleeved jacket and durable long pants for riding (or a protective suit)

Riding Precautions

Break-in Period

During the first 300 miles (500 km) of running, follow these guidelines to ensure your vehicle's future reliability and performance.

- Avoid full-throttle starts and rapid acceleration.
- Avoid hard braking and rapid down-shifts.
- Ride conservatively.

Brakes

Observe the following guidelines:

- Avoid excessively hard braking and downshifting.
 - ▶ Sudden braking can reduce the vehicle's stability.
 - ▶ Where possible, reduce speed before turning; otherwise you risk sliding out.

- Exercise caution on low traction surfaces.
 - ▶ The tires slip more easily on such surfaces and braking distances are longer.
- Avoid continuous braking.
 - ▶ Repeated braking, such as when descending long, steep slopes can seriously overheat the brakes, reducing their effectiveness. Use engine braking with intermittent use of the brakes to reduce speed.
- For full braking effectiveness, operate both the front and rear brakes together.

■ Anti-lock Brake System (ABS)

This model is equipped with an Anti-lock Brake System (ABS) designed to help prevent the brakes from locking up during hard braking.

- ABS does not reduce braking distance. In certain circumstances, ABS may result in a longer stopping distance.
- ABS does not function at speeds below 6 mph (10 km/h).
- The brake lever and pedal may recoil slightly when applying the brakes. This is normal.
- Always use the recommended front/rear tires and sprockets to ensure correct ABS operation.

Engine Braking

Engine braking helps slow your vehicle down when you release the throttle. For further slowing action, downshift to a lower gear. Use engine braking with intermittent use of the brakes to reduce speed when descending long, steep slopes.

Wet or Rainy Conditions

Road surfaces are slippery when wet, and wet brakes further reduce braking efficiency. Exercise extra caution when braking in wet conditions.

If the brakes get wet, apply the brakes while riding at low speed to help them dry.

Parking

- Park on a firm, level surface.
- If you must park on a slight incline or loose surface, park so that the vehicle cannot move or fall over.
- **CMX1100D/D2/D3**
Be sure the parking brake is applied while parking. ➤ P. 93
- Make sure that high-temperature parts cannot come into contact with flammable materials.
- Do not touch the engine, muffler, brakes and other high-temperature parts until they cool down.
- To reduce the likelihood of theft, always lock the handlebar and remove the key when leaving the vehicle unattended. Use of an anti-theft device is also recommended.

■ Parking with the Side Stand

1. Stop the engine.
2. **CMX1100D/D2/D3**
Apply the parking brake. ➤ P. 93
3. Push the side stand down.
4. Slowly lean the vehicle to the left until its weight rests on the side stand.
5. Turn the handlebar fully to the left.
▶ Turning the handlebar to the right reduces stability and may cause the vehicle to fall.
6. Turn the ignition switch to the OFF position and remove the key.
7. Lock the steering. ➤ P. 88

■ Refueling and Fuel Guidelines

Follow these guidelines to protect the engine, fuel system and catalytic converter:

- Use only unleaded gasoline.
- Use the recommended octane number.
Using lower octane gasoline will result in decreased engine performance.
- Do not use fuels containing a high concentration of alcohol. ➤ P. 200
- Do not use stale or contaminated gasoline or an oil/gasoline mixture.
- Avoid getting dirt or water in the fuel tank.

Honda Selectable Torque Control

When the Honda Selectable Torque Control (Torque Control) detects rear wheel spin during acceleration, the system will limit the amount of torque applied to the rear wheel based on the Torque Control level selected.

Additionally, the system eases the rapid motion of the front wheel lifting when accelerating based on the Torque Control level selected.

Torque Control will allow some wheel spin during acceleration at the lower Torque Control setting levels. Select a level that is appropriate for your skill and riding conditions.

Torque Control does not work during deceleration and will not prevent the rear wheel from skidding due to engine braking. Do not close the throttle suddenly, especially when riding on slippery surfaces.

Torque Control may not compensate for rough road conditions or rapid throttle operation.

Always consider road and weather conditions, as well as your skills and condition, when applying throttle.

If your vehicle gets stuck in mud, snow, or sand, it may be easier to free it by turning off the Torque Control temporarily.

Temporarily turning off Torque Control also may help you maintain control and balance when riding on off-road terrain.

Always use the recommended tires and sprockets to ensure correct Torque Control operation.

Accessories & Modifications

We strongly advise that you do not add any accessories that were not specifically designed or approved for your vehicle by Honda or make modifications to your vehicle from its original design. Doing so can make it unsafe. Modifying your vehicle may also void your warranty and make your vehicle illegal to operate on public roads. Before deciding to install accessories on your vehicle, be certain the modification is safe and legal.

WARNING

Improper accessories or modifications can cause a crash in which you can be seriously hurt or killed.

Follow all instructions in this owner's manual regarding accessories and modifications.

Do not pull a trailer with, or attach a sidecar to, your vehicle. Your vehicle was not designed for these attachments, and their use can seriously impair your vehicle's handling.

Loading

- USA model (Model not equipped with Optional Passenger Seat Kit)

Never carry a passenger. Your vehicle was not designed to carry a passenger.

- Carrying extra weight affects your vehicle's handling, braking and stability. Always ride at a safe speed for the load you are carrying.
- Avoid carrying an excessive load and keep within specified load limits.
Maximum weight capacity ➤ P. 209
- Tie all luggage securely, evenly balanced, and close to the center of the vehicle.
- Do not place objects near the lights or the muffler.

WARNING

USA model (Model not equipped with Optional Passenger Seat Kit)

Overloading, improper loading, or carrying a passenger can cause a crash and you can be seriously hurt or killed.

Canada model and USA model equipped with Optional Passenger Seat Kit

Overloading or improper loading can cause a crash and you can be seriously hurt or killed.

Follow all load limits and other loading guidelines in this manual.

USA only

Your vehicle comes from the factory with a single seat for operator only, but has the capacity (subject to applicable weight ratings) to also carry a passenger with the purchase and installation of the optional Honda Accessory Passenger Seat Kit, or equivalent parts specifically designed for this vehicle.

Do not carry a passenger unless a passenger seat (with seat strap) and footpegs have been securely installed on your vehicle.

⚠ WARNING

Carrying a passenger without a properly designed and installed passenger seat and footpegs can result in serious injury or death to you and/or the passenger.

Never carry a passenger without first installing a passenger seat (with seat strap) and footpegs specifically designed for this vehicle. Further, never carry more than one passenger.

Loading

USA only

The vehicle GVWR, weight ratings, and tire load capacities can be found on the vehicle. Single Seat as produced.

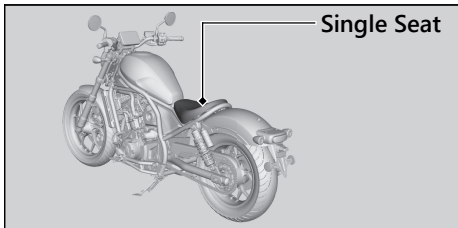

Optional Honda Accessory Passenger Seat Kit shown.

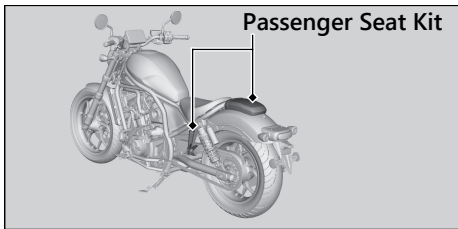

This page intentionally left blank.

Parts Location

Canada model and USA model equipped with Optional Passenger Seat Kit shown

CMX1100A/D

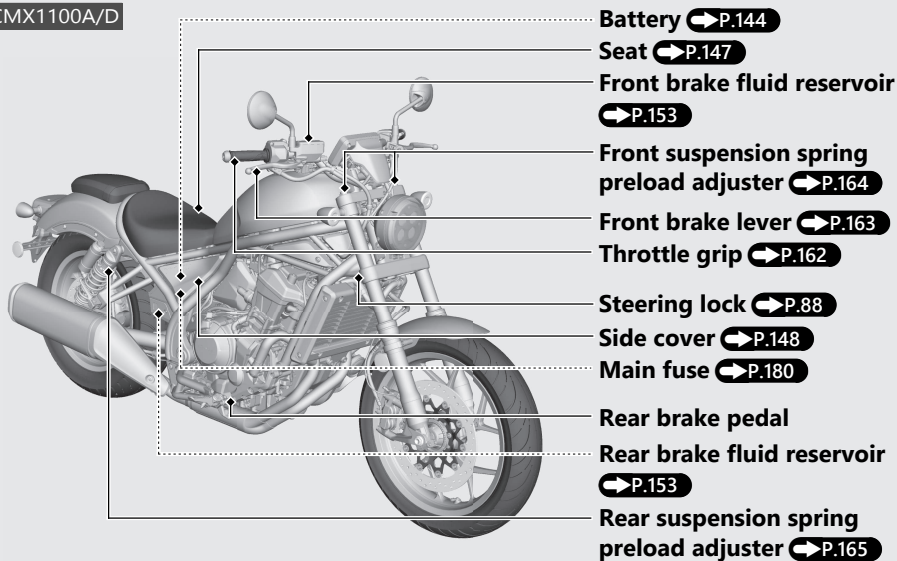

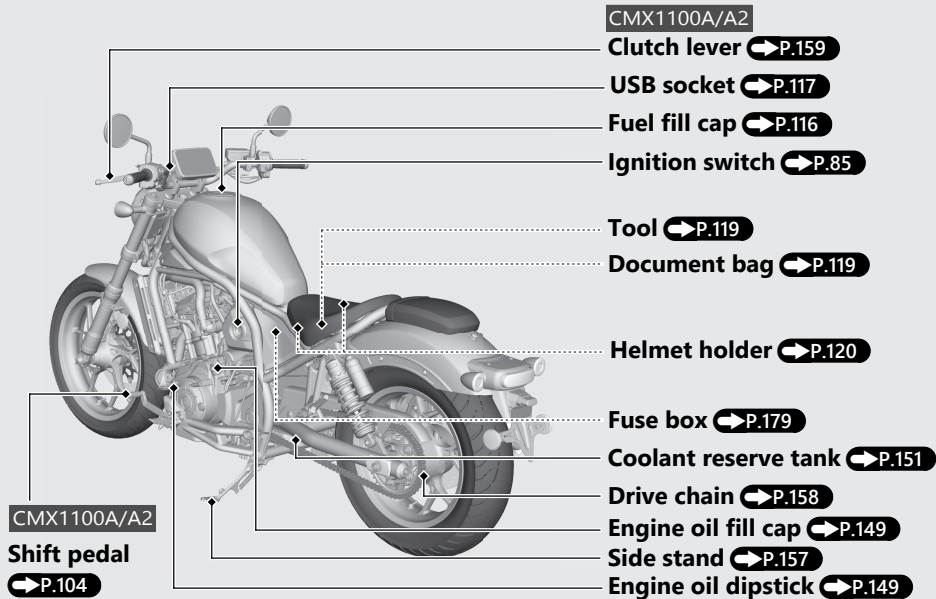

Parts Location *(Continued)*

Canada model and USA model equipped with Optional Passenger Seat Kit shown

CMX1100A2/D2

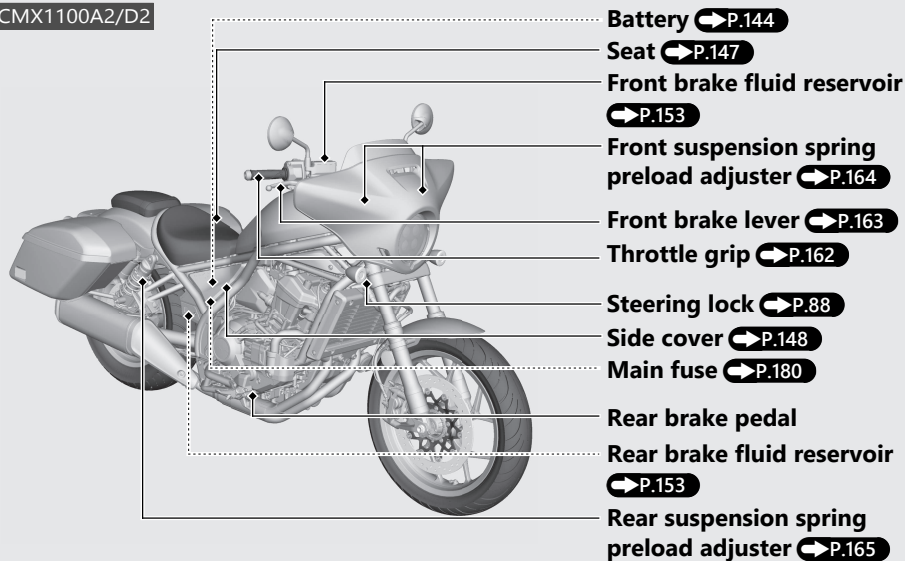

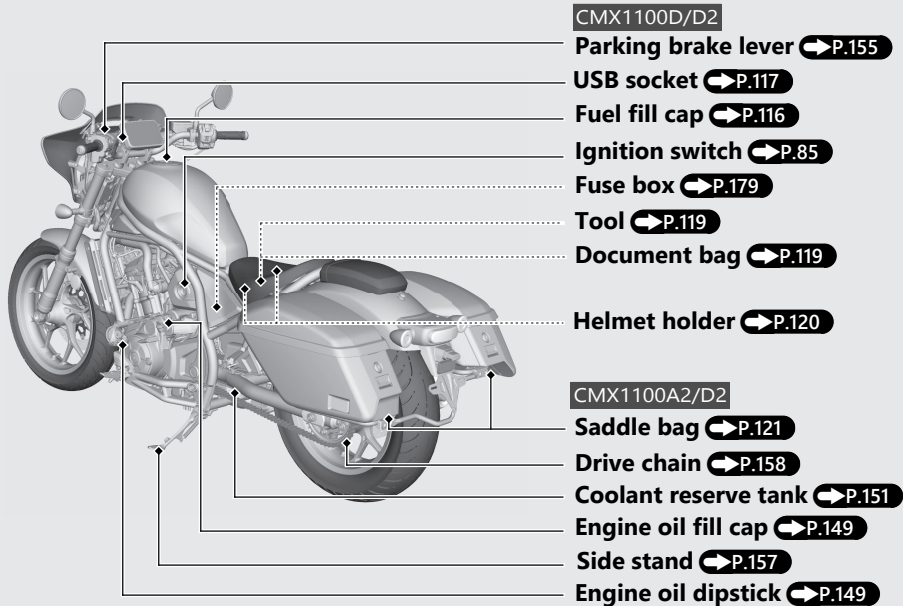

Parts Location *(Continued)*

USA model equipped with Optional Passenger Seat Kit shown

CMX1100D3

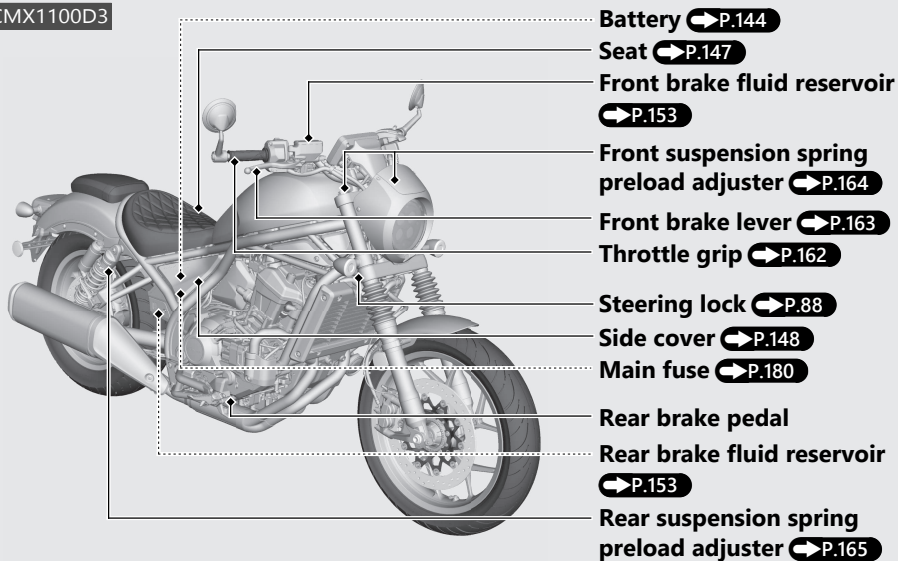

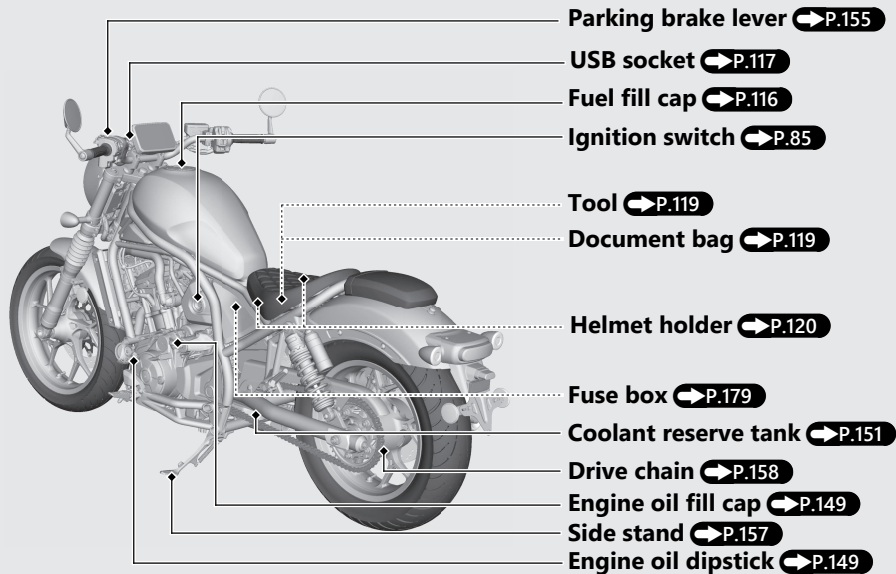

Instruments

You can change the speed and mileage, and fuel mileage meter units. ➡ P.50 ➡ P.67



Do not operate the display functions for a long time with the engine stopped. It may result in a low (or dead) battery.

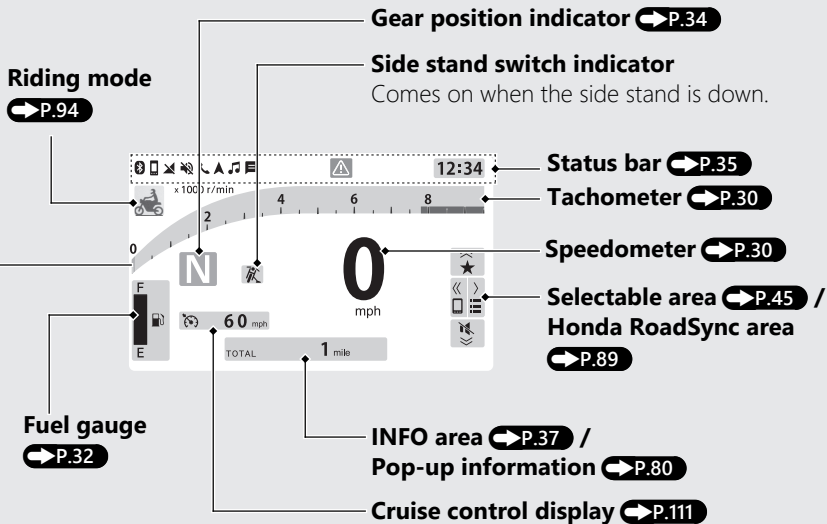

Instruments *(Continued)*

Speedometer/Tachometer/Fuel gauge/INFO area/Cruise control display

Display type: BAR

Tachometer

NOTICE

Do not operate the engine in the tachometer red zone. Excessive engine speed can adversely affect engine life.

Tachometer red zone

(excessive engine rpm range)

Fuel gauge

INFO area

Speedometer

Cruise control display

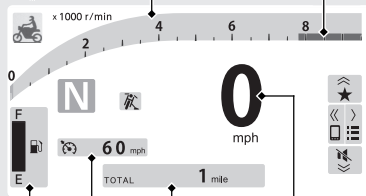

This meter has three display types.

The display and arrangement of speedometer, tachometer, and INFO area change depending on each display type.

► The tachometer is not displayed when select the SIMPLE type display.

To change the display type: P.50 P.58

Display type: CIRCLE

Tachometer **Cruise control display**

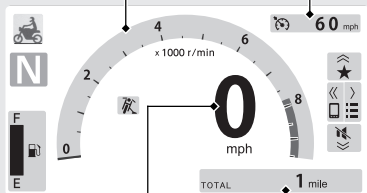

Speedometer **INFO area**

Display type: SIMPLE

Cruise control display

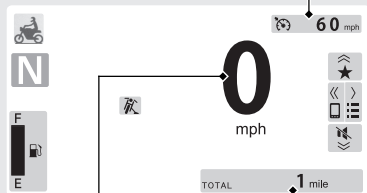

Speedometer **INFO area**

Instruments (Continued)

Fuel

This display has two information types.

- ▶ When the available driving distance (RANGE) becomes amber (Remaining fuel: below 1.06 US gal (4.0 L)), the fuel gauge (FUEL) is no longer available.

To change the display type: P.45 P.46 P.48

Display type: FUEL

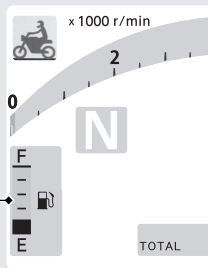

Fuel gauge (FUEL) P.33

Display type: RANGE

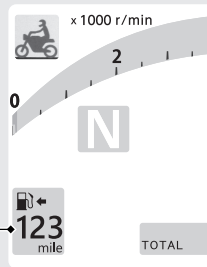

Available driving distance (RANGE) P.33

Fuel gauge (FUEL)

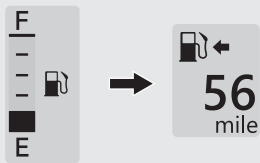

Remaining fuel when the display changes the 1st segment of the fuel gauge (FUEL) to the available driving distance (RANGE) (amber): approximately 1.06 US gal (4.0 L)

► **If the fuel gauge indicator flashes in a repeat pattern or turns off:** ➔ **P.173**

NOTICE

You should refuel when the available driving distance (RANGE) (amber) appears. Running out of fuel can cause the engine to misfire, damaging the catalytic converter.

Available driving distance (RANGE)



Displays the estimated distance you can travel on the remaining fuel.

Display range: 999 to 3 miles (999 to 5 km)

- If the estimated distance exceeds 999 miles or km, "999" is displayed.
- Initial display: "---" is displayed.
- When the available driving distance is below 3 miles (5 km) or the amount of remaining fuel is below 0.2 US gal (1.0 L), "---" is displayed.

Instruments *(Continued)*

The indicated available driving distance is calculated based on driving conditions, and the indicated figure may not always be the actual allowable distance.

When "---" is displayed except for the above-mentioned cases, go to your dealer for service.

Gear position indicator

CMX1100A/A2

The gear position is shown in the gear position indicator.

- ▶ "-" appears when the transmission is not shifted properly.

CMX1100D/D2/D3

The gear position is shown in the gear position indicator.

The indicator may flash if:

- ▶ The front wheel leaves the ground.
- ▶ You turn the wheel while the vehicle is upright on the stand.

This is normal. To operate the system again, turn the ignition switch to the OFF position, and then to the ON position again.

Status bar



Status icons

Displays the status of the Honda RoadSync system. ➔P.89

High beam indicator

Warning indicator

Comes on when your vehicle has warning information. Also displays as pop-up information in the INFO area and WARNING INFO display. ➔P.78 ➔P.80

Parking brake indicator

CMX1100D/D2/D3

Lights as a reminder that you have not released the parking brake lever. ➔P.93

Air temperature gauge

➔P.36

Clock (12-hour or 24-hour display)

To set the clock: ➔P.50 ➔P.66

Instruments *(Continued)*

Air temperature gauge

Displays the ambient temperature.

Display range: 14 °F (-10 °C) to 122 °F (50 °C)

- Less than 14 °F (-10 °C): “---” is displayed
- Above 122 °F (50 °C): 122 °F (50 °C) flashes

Road heat and exhaust from another vehicle can affect the temperature reading when your vehicle speed is less than 19 mph (30 km/h). It may take several minutes for the display to be updated after the temperature reading has stabilized.

Display or hide the air temperature gauge.



INFO area

The INFO area displays various vehicle information.

The following items are displayed by default.

- Odometer [TOTAL]
- Current fuel mileage [INST. CONS.]
- Tripmeter A [TRIP A]
- Tripmeter B [TRIP B]

The information item displayed in the INFO area can be changed arbitrarily.

Up to 10 items are available. (Including Blank)
If no item is selected or only Blank is selected, the INFO area has no items.

To change the information: ➡ P.50

➡ P.61

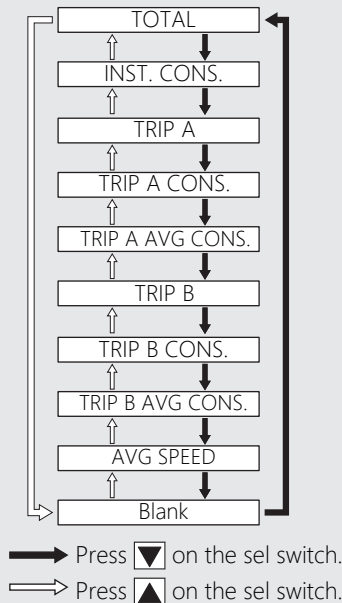

Instruments *(Continued)*

The types of information item that can be displayed in the INFO area are as follows:

TOTAL ➔ P.39

INST. CONS. ➔ P.39

TRIP A ➔ P.40

TRIP A CONS. ➔ P.40

TRIP A AVG CONS. ➔ P.41

TRIP B ➔ P.42

TRIP B CONS. ➔ P.42

TRIP B AVG CONS. ➔ P.43

AVG SPEED ➔ P.44

Blank ➔ P.44

Odometer [TOTAL]

Total distance ridden.

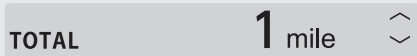

When "-----" is displayed, go to your dealer for service.

Current fuel mileage [INST. CONS.]

Displays the instantaneous fuel mileage as a bar graph.

Display range:

USA model

0 to 100 mile/gal (4 L/100 km or 40 km/L)

Canada model

0 to 200 mile/gal (8 L/100 km or 80 km/L)

- When your speed is less than 3 mph (5 km/h): "zero segment " is displayed.

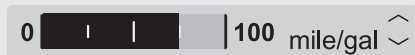
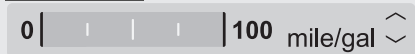
**Zero segment**

When "zero segment " is displayed, except for the above-mentioned cases, go to your dealer for service.

Instruments *(Continued)*

■ Tripmeter A [TRIP A]

Distance ridden since the tripmeter A was reset.

TRIPA **125.0** mile 

When "----.-" is displayed, go to your dealer for service.

To reset the tripmeter A:  **P.46**

 **P.49**

■ Tripmeter A fuel consumption [CONS.A]

Displays the tripmeter A fuel consumption since the tripmeter A was reset.

Display range: 0.0 to 299.9 gal (L)

CONS.A **2.8** gal 

When "---.-" is displayed go to your dealer for service.

Tripmeter A fuel consumption is reset when you reset tripmeter A.

To reset the tripmeter A:  **P.46**

 **P.49**

■ Tripmeter A average fuel mileage [AVG CONS. A]

Displays the average fuel mileage since the tripmeter A was reset.

The average fuel mileage will be calculated based on the value on tripmeter A.

Display range: 0.0 to 299.9 mile/gal (L/100 km or km/L)

- Above 299.9 L/100km : "--.-" is displayed.
- Above 299.9 mile/gal (km/L) : "299.9" is displayed.
- When the average fuel mileage is reset: "---.-" is displayed.

AVG CONS. A **25.0** mile/gal  

When "--.-" is displayed except for the above-mentioned cases, go to your dealer for service.

Tripmeter A average fuel mileage is reset when you reset tripmeter A.

To reset the tripmeter A:  **P.46**

 **P.49**

Instruments *(Continued)*

■ Tripmeter B [TRIP B]

Distance ridden since the tripmeter B was reset.

TRIP B **150.0** mile 

When "----.-" is displayed, go to your dealer for service.

To reset the tripmeter B:  **P.46**

 **P.49**

■ Tripmeter B fuel consumption [CONS.B]

Displays the tripmeter B fuel consumption since the tripmeter B was reset.

Display range: 0.0 to 299.9 gal (L)

CONS.B **1.4** gal 

When "---.-" is displayed go to your dealer for service.

Tripmeter B fuel consumption is reset when you reset tripmeter B.

To reset the tripmeter B:  **P.46**

 **P.49**

■ Tripmeter B average fuel mileage [AVG CONS. B]

Displays the average fuel mileage since the tripmeter B was reset.

The average fuel mileage will be calculated based on the value on tripmeter B.

Display range: 0.0 to 299.9 mile/gal (L/100 km or km/L)

- Above 299.9 L/100km : "--.-" is displayed.
- Above 299.9 mile/gal (km/L) : "299.9" is displayed.
- When the average fuel mileage is reset: "---.-" is displayed.

AVG CONS. B **28.0** mile/gal  

When "--.-" is displayed except for the above-mentioned cases, go to your dealer for service.

Tripmeter B average fuel mileage is reset when you reset tripmeter B.

To reset the tripmeter B:  **P.46**

 **P.49**

Instruments *(Continued)*

Average speed [AVG SPEED]

Displays average speed since the engine was started.

Display range: 0 to 186 mph (0 to 299 km/h)

- Initial display: "---" is displayed.
- When your vehicle has traveled less than 0.12 mile (0.2 km) since the engine was started: "---" is displayed.
- When your vehicle operating time is less than 16 seconds since the engine was started: "---" is displayed.

AVG SPEED **25** mph 

When "---" is displayed except for the above-mentioned cases, go to your dealer for service.



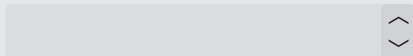

Blank display

Display is blank.



Selectable area



You can select the following:

- General menu  P.46
- Honda RoadSync transition  P.89
- Honda RoadSync mute
- FAVORITE SWITCH (Fuel mode or Trip reset mode)  P.48  P.49

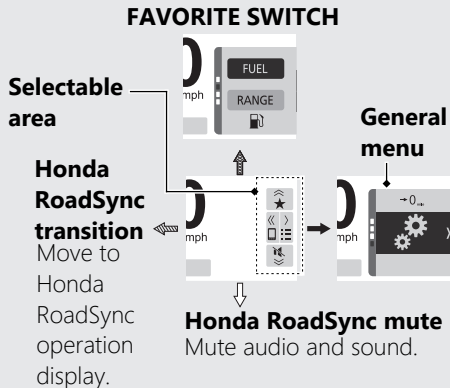

Honda RoadSync transition and Honda RoadSync mute can be selected only when your smartphone is connected to the vehicle.



To connect the device  P.92



 Press and hold the  on the sel switch

 Press  on the sel switch

 Press and hold the  on the sel switch

 Press and hold the  on the sel switch

Instruments *(Continued)*

General Menu

You can select the following:

- Status mode
- Fuel mode
- Trip reset mode
- Setting mode

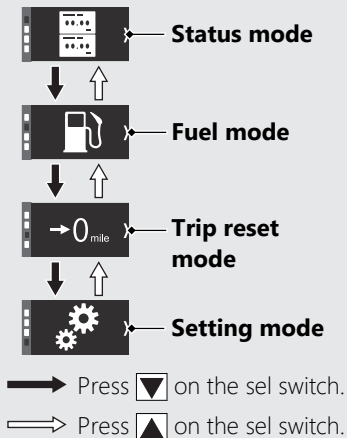

Status mode

The Status mode displays various vehicle information.

The Status mode has four pages and displays two pieces of information on each page. The fifth page displays the selected riding mode.

Press on the sel switch while select the status mode, display moves to vehicle information page.

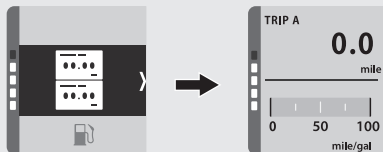



The information items on the four pages displayed in status mode can be changed as desired.

To change the information: **P.50**

P.61

To switch the information page

To change the information page, press  or  on the sel switch.

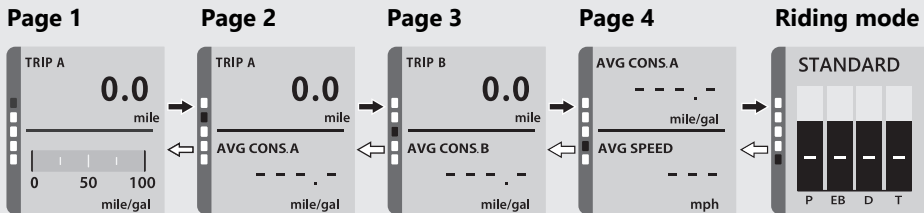

 Press  on the sel switch.



 Press  on the sel switch.



To change the information:  P.50  P.61

Instruments *(Continued)*



Fuel mode

You can select the following:

- FUEL  **P.33**
 - RANGE  **P.33**
- ▶ When the available driving distance (RANGE) becomes amber (Remaining fuel: below 1.06 US gal (4.0 L)), the fuel gauge (FUEL) is no longer available.

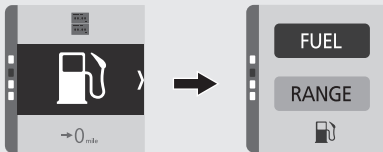
1. Select the fuel mode.  **P.46**
2. Press  on the sel switch.



3. Select the FUEL or RANGE by pressing the  or  on the sel switch.

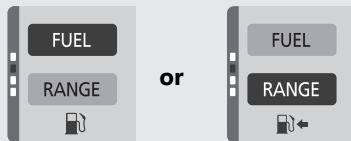

Trip reset mode

You can reset the tripmeter A or tripmeter B.

1. Select the trip reset mode. **P.46**
2. Press on the sel switch.

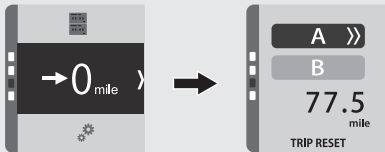

3. Select the A or B by pressing the or on the sel switch.



4. Press and hold the on the sel switch. The tripmeter A or B is reset.

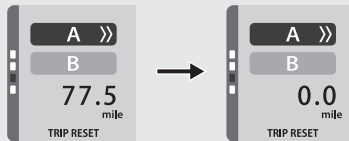



Also, the tripmeter A, tripmeter A fuel consumption and tripmeter A average fuel mileage are automatically reset when the fuel gauge segment increases by 2 or more after refueling and riding your vehicle for 0.06 mile (0.1 km). You can activate or deactivate the automatic reset mode. **P.50** **P.57**

Instruments (Continued)

Setting mode

To shift to the setting mode

1. Select the general menu.  P.45
2. Select the setting mode.  P.46
3. Press  on the sel switch, and then display moves to the setting mode.
 - ▶ Operation while driving is prohibited.

Ordinary display

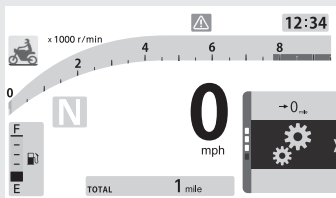

Setting mode

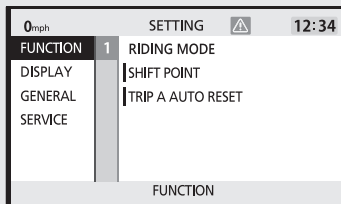

To return to the ordinary display

- Press  on the sel switch until return to the ordinary display.
- Turn the ignition switch to the OFF position, and then to the ON position again.

Setting flow

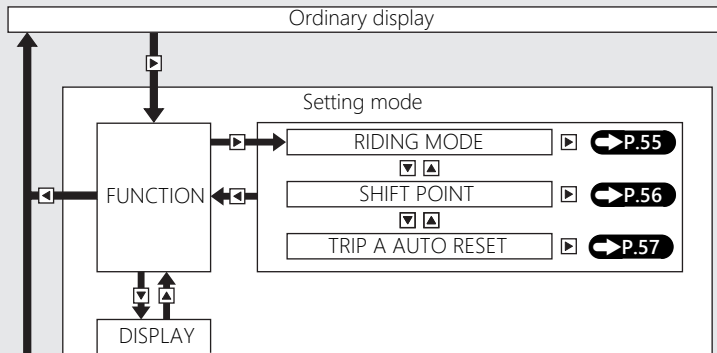

▶ Press ▶ on the sel switch

◀ Press ◀ on the sel switch

▲ Press ▲ on the sel switch

▼ Press ▼ on the sel switch

Instruments (Continued)

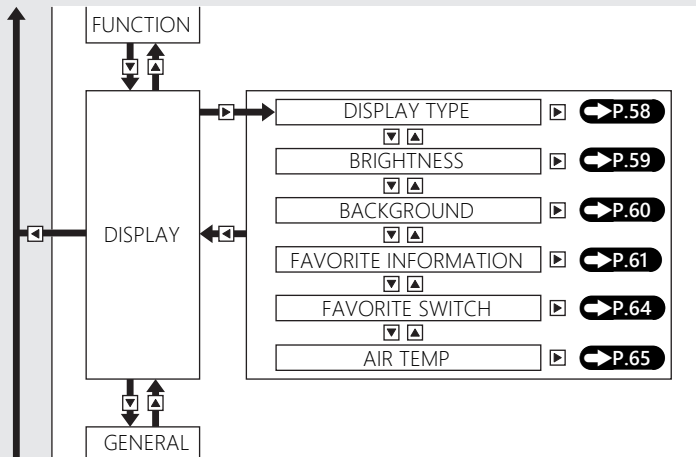

- ▶ Press ▶ on the sel switch
- ◀ Press ◀ on the sel switch
- ▲ Press ▲ on the sel switch
- ▼ Press ▼ on the sel switch

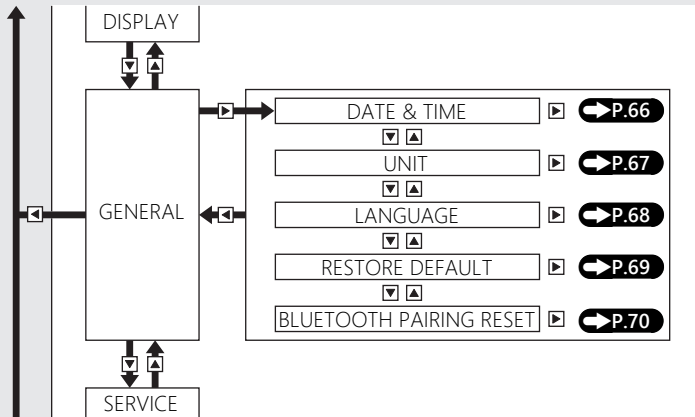

- ▶ Press ▶ on the sel switch
- ◀ Press ◀ on the sel switch
- ▲ Press ▲ on the sel switch
- ▼ Press ▼ on the sel switch

Instruments (Continued)

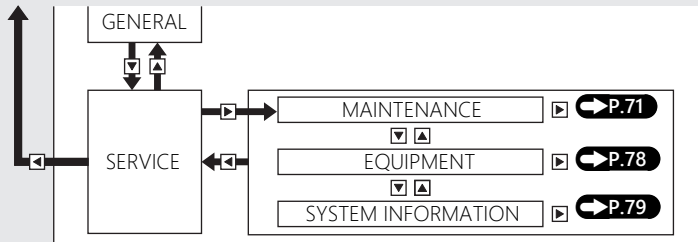









- ▶ Press ▶ on the sel switch
- ◀ Press ◀ on the sel switch
- ▲ Press ▲ on the sel switch
- ▼ Press ▼ on the sel switch

RIDING MODE P.94

1. USER MODE

You can change the setting value of the USER MODE.





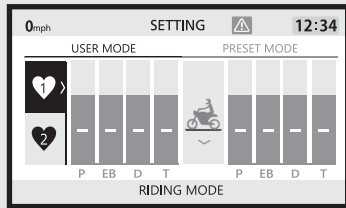

- 1 Select the USER 1 or USER 2 using  or  of the sel switch.
- 2 Select the parameter using  or  of the sel switch.
 - ▶ Parameter selection :
CMX1100A/A2 P, EB, T
CMX1100D/D2/D3 P, EB, D, T
- 3 Select the desired setting value using  or  of the sel switch.
- 4 Press  on the sel switch to complete the setting.
- 5 Return to the ordinary display to complete the setting.  P.50

To continue setting, press  on the sel switch to return to the upper hierarchy.



2. PRESET MODE

You can confirm the preset riding mode setting value of the STANDARD, SPORT, RAIN.

- 1 Select the PRESET MODE using  of the sel switch.
- 2 Select the desired riding mode using  or  of the sel switch.
- 3 Press  on the sel switch to return to USER MODE.
- 4 Return to the ordinary display.  P.50
To continue setting, press  on the sel switch to return to the upper hierarchy.

Instruments *(Continued)*

SHIFT POINT

| (On) / **○** (Off): You can activate or deactivate the shift indicator.

SHIFT POINT : You can change the engine revolutions at which the tachometer start blinking in the shift indicator.

- 1 Select the **|** (On) or **○** (Off) using **▲** or **▼** on the sel switch.

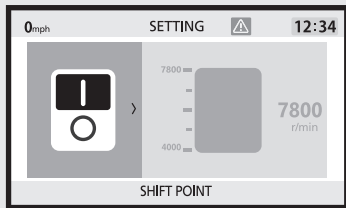

- 2 When select the **|** (On)

Press **▶** on the sel switch to select the desired setting using **▲** or **▼** on the sel switch.

Press **◀** on the sel switch to complete the setting.

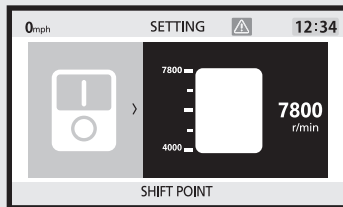

- When select the **○** (Off)

Press **◀** on the sel switch to complete the setting.

- 3 Return to the ordinary display to complete the setting. **➡ P.50**

To continue setting, press **◀** on the sel switch to return to the upper hierarchy.

TRIP A AUTO RESET

You can enable or disable the tripmeter A automatic reset mode.

- 1 Select the (On) or (Off) using or on the sel switch.
- 2 Press on the sel switch to complete the setting.
- 3 Return to the ordinary display to complete the setting. **➔P.50**

To continue setting, press on the sel switch to return to the upper hierarchy.

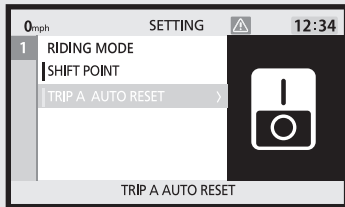

Instruments *(Continued)*

DISPLAY TYPE

You can change the display type. ➡ P.30

- 1 Select the display type ("BAR", "CIRCLE" or "SIMPLE") using ▲ or ▼ on the sel switch.
- 2 Press ◀ on the sel switch to complete the setting.
- 3 Return to the ordinary display to complete the setting. ➡ P.50

To continue setting, press ◀ on the sel switch to return to the upper hierarchy.

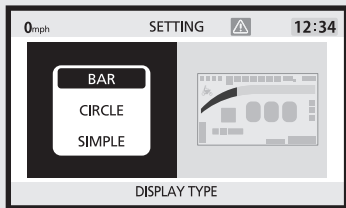



BRIGHTNESS

You can adjust the backlight brightness to one of the eight levels or select the auto adjustment.

Automatic brightness control: P.184

The display can become dark when the display is very hot. If it does not restore the original brightness, contact your dealer.

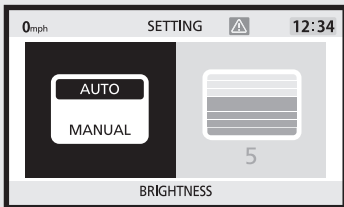

- 1 Select the "AUTO" or "MANUAL" using  or  on the sel switch.



- 2 When select the "AUTO"



Press  on the sel switch to complete the setting.

When select the "MANUAL"

Press  on the sel switch to select the backlight brightness using  or  on the sel switch.

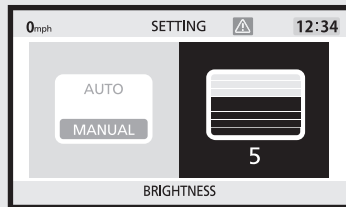
Press  on the sel switch to complete the setting.



- 3 Return to the ordinary display to complete the setting.  P.50
To continue setting, press  on the sel switch to return to the upper hierarchy.

Instruments *(Continued)*

BACKGROUND

You can change the setting of the background to one of the two colors or select the auto adjustment.

- 1 Select the background color using ▲ or ▼ on the sel switch.
- 2 Press ◀ on the sel switch to complete the setting.
- 3 Return to the ordinary display to complete the setting. ➡ P.50

To continue setting, press ◀ on the sel switch to return to the upper hierarchy.

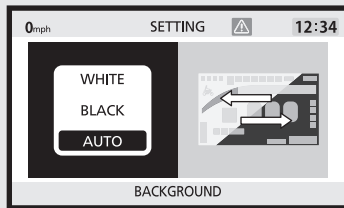

FAVORITE INFORMATION

You can change the information items displayed in the INFO area and status mode.

1 line information

You can change the information items displayed in the INFO area. ➡ P.37

1 line information setting: ➡ P.62

2 line information

You can change the information items displayed in the information page of status mode. ➡ P.46

2 line information setting: ➡ P.63

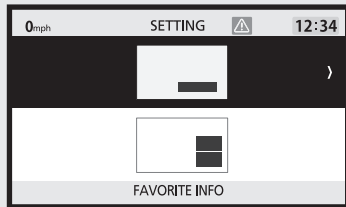

Select the 1 line or 2 line information using ▲ or ▼ on the sel switch.

Press ▶ on the sel switch, display moves to the 1 line or 2 line information setting.

Instruments *(Continued)*

1 line information setting

- ① Select the 1 or 2 using ▲ or ▼ on the sel switch.

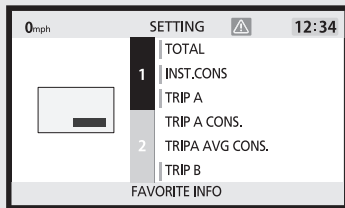

- ② Press ▶ on the sel switch to select the information items.

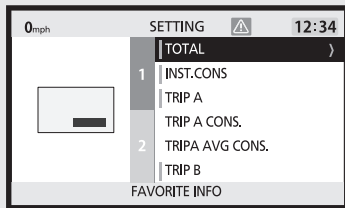

- ③ Select the desired information setting using ▲ or ▼ on the sel switch.
- ④ Press ▶ on the sel switch, set the information item.
- ▶ Items that have already been set are displayed with a green cursor.
 - ▶ Up to 10 items are available. (Including BLANK)
- ⑤ Press ◀ on the sel switch to complete the setting.
- ⑥ Return to the ordinary display to complete the setting. ➡ P.50
- To continue setting, press ◀ on the sel switch to return to the upper hierarchy.

2 line information setting

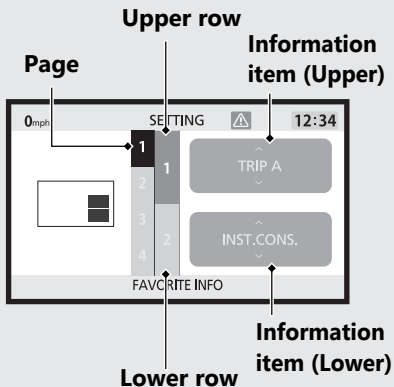

- 1 Select the desired page using or on the sel switch.
- 2 Press on the sel switch to select the upper or lower row.

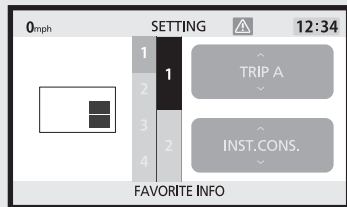

- 3 Select the upper or lower row using or on the sel switch.



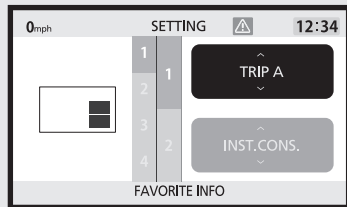



- 4 Press on the sel switch to select the information items.
- 5 Select the desired information item using or on the sel switch.



Instruments *(Continued)*

- 6 Press  on the sel switch to complete the setting.
- 7 Return to the ordinary display to complete the setting.  P.50
To continue setting, press  on the sel switch to return to the upper hierarchy.

FAVORITE SWITCH

- 1 Select the favorite switch using  or  on the sel switch.
- 2 Press  on the sel switch, set the item.
- 3 Press  on the sel switch to complete the setting.
- 4 Return to the ordinary display to complete the setting.  P.50

To continue setting, press  on the sel switch to return to the upper hierarchy.



AIR TEMP

You can display or hide the air temperature gauge. ➡P.35





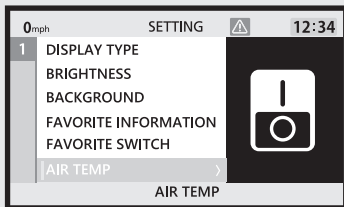

- 1 Select the **I** (On) or **O** (Off) using **▲** or **▼** on the sel switch.
- 2 Press **◀** on the sel switch to complete the setting.
- 3 Return to the ordinary display to complete the setting. ➡P.50

To continue setting, press **◀** on the sel switch to return to the upper hierarchy.



Instruments *(Continued)*

DATE & TIME

- 1 Select the "Day", "Month", "Year", "Hour", "Minute", "24h or 12h" or "AM / PM" using  or  on the sel switch.
- 2 Select the desired setting using  or  on the sel switch.
 - ▶ When "24 / 12" is set to 24-hour indication, "AM / PM" cannot be usable.
- 3 Press  on the sel switch to complete the setting.
- 4 Return to the ordinary display to complete the setting. **→P.50**
To continue setting, press  on the sel switch to return to the upper hierarchy.
 - ▶ The set value is retained.

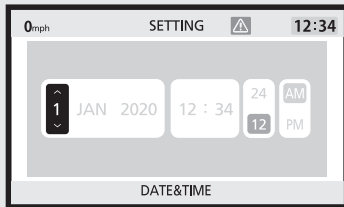

Setting range

Date: 1 to 31

Month: JAN to DEC

Year: 2020 to 2099

Hour: 0 to 23







Minute: 00 to 59

24/12: 24 or 12

AM/PM: AM or PM

UNIT

You can change the speed and mileage, and fuel mileage meter units.

- 1 Select the "SPEED" or "FUEL CONS." using  or  on the sel switch.
- 2 Select the desired setting using  or  on the sel switch.
- 3 Press  on the sel switch to complete the setting.
- 4 Return to the ordinary display to complete the setting. **➔ P.50**
To continue setting, press  on the sel switch to return to the upper hierarchy.
▶ The set value is retained.

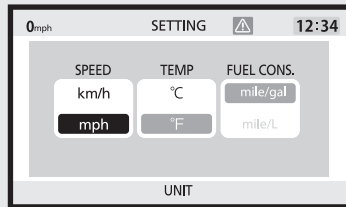

If you want to select "L/100km" or "km/L" for fuel consumption, "km/h" must be selected in the "SPEED" menu in advance. When "mph" for speed is selected, "mile/gal" can be selected.

Instruments *(Continued)*

LANGUAGE

Changes the system language.

- 1 Select the 1 or 2 using ▲ or ▼ on the sel switch.

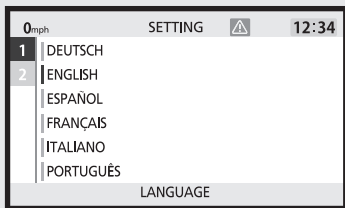

- 2 Press ► on the sel switch.

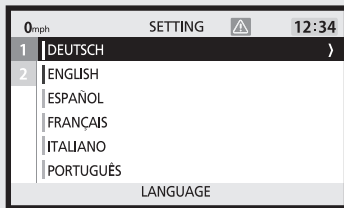

- 3 Select the language using ▲ or ▼ on the sel switch.
- 4 Press ► on the sel switch to select the language.
 - Items that have already been set are displayed with a green cursor.
- 5 Press ◀ on the sel switch to complete the setting.
- 6 Return to the ordinary display to complete the setting. ➡ P.50
To continue setting, press ◀ on the sel switch to return to the upper hierarchy.

RESTORE DEFAULT

The set values can be returned to the default settings.

1 Select the “NO” (not restore) or “YES” (restore) using the  or  on the sel switch.

2 **When the “NO” is selected**

Press the  on the sel switch. The set value is maintained, and then the display returns to the upper level hierarchy.

When the “YES” is selected

Press and hold the  on the sel switch. The set value return to default setting.

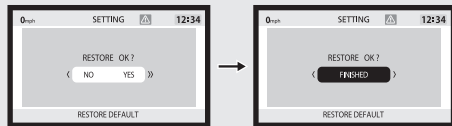

The following items are restored to their default values:



- RIDING MODE
- SHIFT POINT
- TRIP A AUTO RESET
- DISPLAY TYPE
- BRIGHTNESS
- BACKGROUND
- FAVORITE INFORMATION
 - ▶ The page of the currently selected INFO area and status mode are also initialized.
- FAVORITE SWITCH
- AIR TEMP
- UNIT
- LANGUAGE

Instruments (Continued)

BLUETOOTH PAIRING RESET

You can reset the pairing record of *Bluetooth*®.

To connect the device P.92

- 1 Select the "NO" (not reset) or "YES" (reset) using the  or  on the sel switch.
- 2 **When the "NO" is selected**
Press the  on the sel switch. The pairing record is maintained, and then the display returns to the upper level hierarchy.

When the "YES" is selected



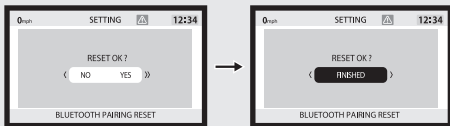

Press and hold the  on the sel switch. The pairing record is reset.



- ▶ If the pairing information remains in your smartphone even if the pairing information is deleted from the vehicle, the smartphone may be connected to the vehicle again.

MAINTENANCE

You can select the following:

- PERIODIC MAINTENANCE  P.72
- OIL CHANGE  P.74
- BATTERY VOLTAGE  P.76
- WATER TEMP  P.77
- WARNING INFO  P.78

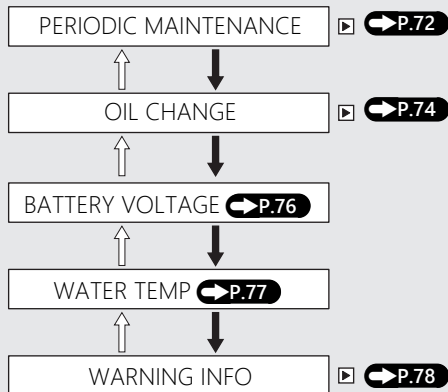
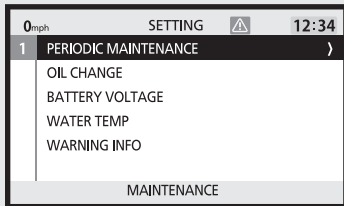

 Press  on the sel switch.

 Press  on the sel switch.

 Press the  on the sel switch

Instruments *(Continued)*

PERIODIC MAINTENANCE

You can check the next periodic inspection time.

You can program a reminder for the next periodic inspection time.

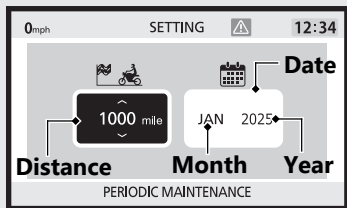

Display range:

Distance:

-----, 8,000 to -99,999 mile (12,000 to -99,999 km)



- ▶ Pass 0 mile (0 km): "-" mark is displayed.
- ▶ Changing the SPEED unit from "mile" to "km" will also display ranges over 12,000 km, depending on the distance.

Date:



Month: ---, JAN to DEC



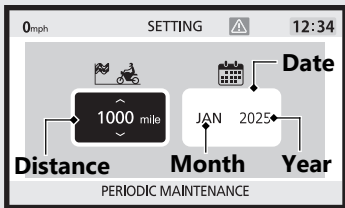

Year: ----, 2020 to 2099

Next inspection setting

- 1 Select the distance, month or year using  or  on the sel switch.



- 2 Select the desired setting using  or  on the sel switch.
 - ▶ If you press and hold  on the sel switch while setting the distance, it will move every 1000.

- ▶ Available setting range of the distance: -----, 100 to 8,000 mile (100 to 12,000 km)
Initial setting:-----
 - ▶ Available setting range of the date:
Month:---, JAN to DEC
Initial setting:---
Year: ----, 2020 to 2099
Initial setting:----
 - ▶ Maintenance information ( **P.80**) will not be displayed if the distance and date are set to the initial settings.
- 3 Press  on the sel switch to complete the setting.
 - 4 Return to the ordinary display to complete the setting.  **P.50**
To continue setting, press  on the sel switch to return to the upper hierarchy.

Instruments *(Continued)*

OIL CHANGE

You can check the next engine oil change.
You can program a reminder for the next engine oil change.

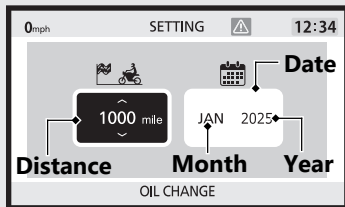

Display range:

Distance:

-----, 8,000 to -99,999 mile (12,800 to -99,999 km)



- ▶ Pass 0 mile (0 km): "-" mark is displayed.
- ▶ Changing the SPEED unit from "mile" to "km" will also display ranges over 12,800 km, depending on the distance.

Date:



Month: ---, JAN to DEC



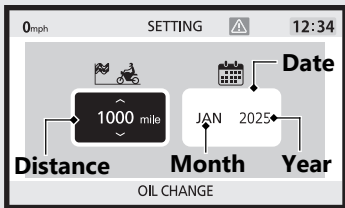

Year: ----, 2020 to 2099

Next oil change setting

- 1 Select the distance, month or year using  or  on the sel switch.



- 2 Select the desired setting using  or  on the sel switch.
 - ▶ If you press and hold  on the sel switch while setting the distance, it will move every 1000.

- ▶ Available setting range of the distance: -----, 100 to 8,000 mile (100 to 12,800 km)
Initial setting:-----
 - ▶ Available setting range of the date:
Month:---, JAN to DEC
Initial setting:---
Year: ----, 2020 to 2099
Initial setting:----
 - ▶ Maintenance information () will not be displayed if the distance and date are set to the initial settings.
- 3 Press  on the sel switch to complete the setting.
 - 4 Return to the ordinary display to complete the setting. 
To continue setting, press  on the sel switch to return to the upper hierarchy.

Instruments *(Continued)*

When reaching any of the following, the pop-up information is appears in the ordinary display. ➡ **P.80**

- "300 mile" ("500 km") from the next periodic inspection.
- "60 mile" ("100 km") from the next engine oil change.
- One month before the set month.

Periodic inspection

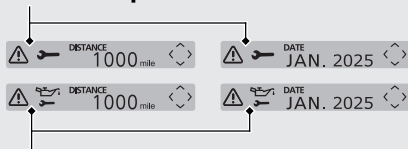

Oil change information

BATTERY VOLTAGE

Displays the current voltage.

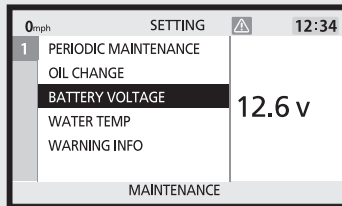

WATER TEMP

Displays the current coolant temperature.

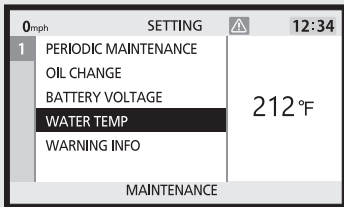

Display range: 94°F (35°C) to 269°F (132°C)

- 93°F (34°C) or less: "---" is displayed.
- Between 251°F (122°C) and 268°F (131°C):
 - High coolant temperature indicator and warning indicator come on. The high coolant temperature indicator is displayed in the warning information. **➡P.78** **➡P.81**
 - Coolant temperature digits flash.

- Above 269°F (132°C):
 - High coolant temperature indicator and warning indicator come on. The high coolant temperature indicator is displayed in the warning information. **➡P.78** **➡P.81**
 - "269°F (132°C)" flashes.
- Even if the engine coolant temperature is low, the cooling fan may start running when you rev up the engine. This is normal.

If the coolant temperature "---" flashes.

➡P.174

Instruments *(Continued)*

WARNING INFO

Displays a current maintenance information and (or) warning information. **➔ P.80**

If your vehicle has warning information, have your vehicle inspected by your dealer as soon as possible.

Warning information

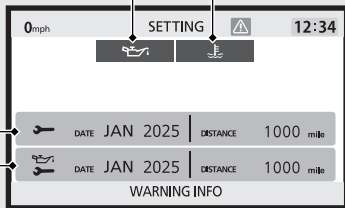

Maintenance information

EQUIPMENT

"EQUIPMENT" is displayed but not selectable.

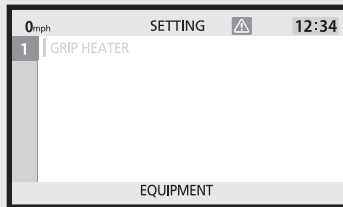

SYSTEM INFORMATION

Displays the software version and hardware information.

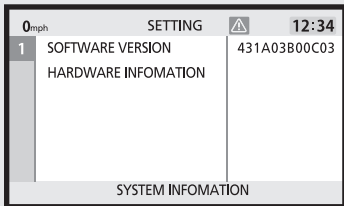

Instruments *(Continued)*

















Pop-up information

In the following cases, pop-up information is displayed at the INFO area.



- Maintenance information:
When the inspection time of your vehicle is approaching.
- Warning information:
When your vehicle has warning information.





When your vehicle has multiple pieces of information, pop-up information display appears alternately.

Maintenance Information

Indication	Explanation	Remedy
  DISTANCE 1000 mile  	When the periodic inspection time of your vehicle is approaching.	Have your vehicle inspected by your dealer.
  DATE JAN 2025  		
  DISTANCE 1000 mile  	When the oil change time of your vehicle is approaching.	Change the engine oil.
  DATE JAN 2025  		



Warning Information

Indication	Explanation	Remedy
<p data-bbox="259 225 525 256">Warning indicator</p>  <p data-bbox="387 363 627 430">Low oil pressure indicator</p>	<p data-bbox="703 288 991 360">When the oil pressure in the engine is low.</p>	<p data-bbox="1038 267 1282 339">Refer to "Low Oil Pressure Indicator"</p> <p data-bbox="1038 350 1161 381">➔ P.169</p>
<p data-bbox="259 446 525 477">Warning indicator</p>  <p data-bbox="331 578 659 645">High coolant temperature indicator</p>	<p data-bbox="703 487 991 560">When the coolant temperature becomes high.</p>	<p data-bbox="1038 508 1336 539">Refer to "Overheating"</p> <p data-bbox="1038 550 1161 581">➔ P.168</p>

You can hide the pop-up information by pushing either the     sel switch while the pop-up information is displayed.

Indicators

If one of these indicators does not come on when it should, have your dealer check for problems.

Refer to the "Instruments" about indicators appeared on the display:  **P.35**  **P.81**

 **Left turn signal indicator**

 **Right turn signal indicator**



 **Neutral indicator**

Comes on when the transmission is in Neutral.

 **PGM-FI (Programmed Fuel Injection) malfunction indicator lamp (MIL)**

Comes on briefly when the ignition switch is turned to the ON position.

If it comes on or flashes while engine is running:  **P.169**

 **ABS (Anti-lock Brake System) indicator**

- Comes on when the ignition switch is turned to the ON position.
- Goes off when your speed reaches approximately 6 mph (10 km/h).

If it comes on while riding:  **P.170**

Torque Control indicator

- Comes on when the ignition switch is turned to the ON position. Goes off when your speed reaches approximately 3 mph (5 km/h) to indicate Torque Control is ready to work.
- Blinks when Torque Control is operating.

If it comes on while riding:  **P.171**



Torque Control OFF Indicator

Comes on when the Torque Control is turned Off.

Switches

Left handlebar switch → P.87

Right handlebar switch → P.86

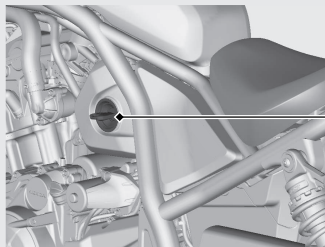
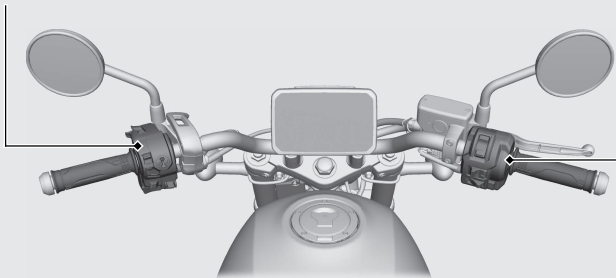

Ignition switch

Switches the electrical system on/off.

- ▶ Key can only be removed when in the OFF position.

Steering Lock: → P.88

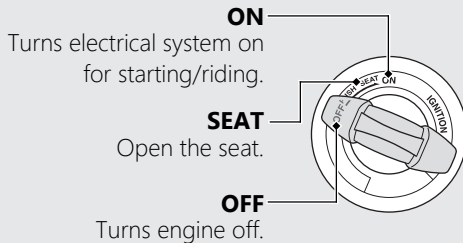

Switches *(Continued)*

Right handlebar switch

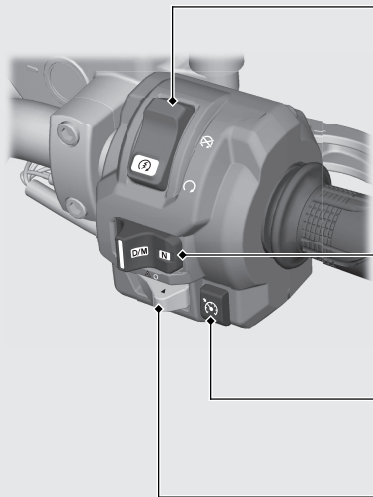

Engine stop switch/⏻ Start button

Should normally remain in the ⏻ (Run) position.

▶ In an emergency, switch to the ⏻ (Stop) position to stop the engine.

N-D/M switch

CMX1100D/D2/D3

To shift between Neutral and AT MODE or MT MODE. ➡ P.109

⏻ Cruise control main switch

Press to activate the cruise control system.

➡ P.111

⚠ Hazard switch

Switchable when the ignition switch is turned to the ON position.

Left handlebar switches

Shift up switch (+)

CMX1100D/D2/D3

To shift up the gear. ➔ P.110

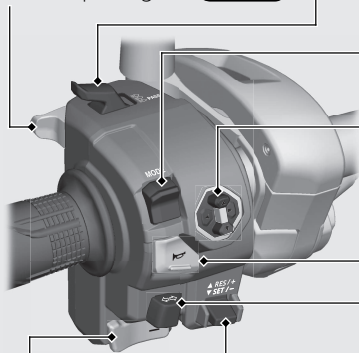

Headlight dimmer switch/Passing switch

- ☰☐ : High beam
- ☰☐☐ : Low beam
- ☰☐ **PASS** : Flashes the high beam headlight.

MODE switch

Used to change the riding mode. ➔ P.94

▲ ▼ ◀ ▶ Sel switch

Used to operate and set the display. ➔ P.45

Also used to operate the Honda RoadSync. ➔ P.89

Also used to set the riding mode. ➔ P.94

📣 Horn button

↔ Turn signal switch

RES / + SET / - Cruise control lever

Push up or down to set the speed or adjust the set speed. ➔ P.113

Shift down switch (-)

CMX1100D/D2/D3

To shift down the gear. ➔ P.110

Switches *(Continued)*

Steering Lock

Lock the steering when parking to help prevent theft.

A U-shaped wheel lock or similar device is also recommended.

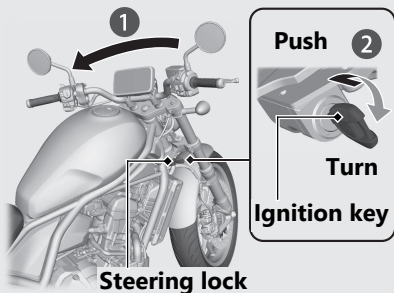

Locking

- 1 Turn the handlebar all the way to the left.
- 2 Insert the ignition key in the steering lock.
- 3 Push the ignition key down, and turn it 180 degrees clockwise.
 - ▶ Jiggle the handlebar if the lock is difficult to engage.
- 4 Remove the ignition key.

Unlocking

Insert the ignition key, push it in, and turn it 180 degrees counterclockwise.

Honda RoadSync

Connecting your smartphone with the vehicle and a *Bluetooth*® headset via *Bluetooth*® allows you to operate the smartphone by voice input from the headset. You can also use the system by operating switches on the handlebar.

- ▶ To use the system, you need to install the dedicated application on your smartphone beforehand and pair your smartphone with the vehicle and the headset.

For terms of service and information on how to install/operate the dedicated application, see the following URL:

<https://global.honda/voice-control-system/>



- ▶ The dedicated application is not available in some regions/countries. For available countries, see the above URL.

Honda RoadSync *(Continued)*

Communication range:

Within 1 meters radius from vehicle

Supported *Bluetooth*® version/profiles

<i>Bluetooth</i> ® version	Bluetooth 4.2 or higher
<i>Bluetooth</i> ® profiles	GATT (Generic Attribute Profile)
	HOGP (HID over GATT Profile)

Bluetooth® Wireless Technology

The *Bluetooth*® word mark and logos are registered trademarks owned by Bluetooth SIG, Inc., and any use of such marks by Honda Motors Co., Ltd., is under license. Other trademarks and trade names are those of their respective owners.

- Costs of network communication and communication equipment necessary for the use of this feature shall be borne by the user.
- You cannot pair two or more smartphones at once.
- Some smartphones may not be compatible with the feature.
- We shall not be liable for any damages or trouble in the use of smartphone.
- When unable to connect your smartphone to the vehicle, change the storage location of the smartphone.

The system itself has certain limitations. Therefore, you must verify the voice guidance and information in the meter provided by the system by carefully observing the roadway, signs, and signals, etc. If you are unsure, proceed with caution. Always use your own good judgment, and obey traffic laws while riding.

⚠️ WARNING

Using the Honda RoadSync while riding can take your attention away from the road, causing a crash in which you could be seriously injured or killed.

- Be especially cautious when crossing intersections, in heavy traffic, etc.
- Observe the roadway, signs, and signals, carefully.
- Obey traffic laws while riding.

Honda RoadSync Limitations

Changes in operating systems, hardware, software, and other technology integral to providing Honda RoadSync functionality, as well as new or revised governmental regulations, may result in a decrease or cessation of Honda RoadSync functionality and services.

Honda cannot and does not provide any warranty or guarantee of future Honda RoadSync performance or functionality.

Honda RoadSync (Continued)

Pairing your smartphone via Bluetooth®

- ① Select the BLUETOOTH PAIRING RESET menu. **←P.50** **←P.70**

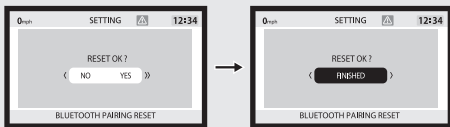

- ② When the "NO" is selected

Press the  on the sel switch. The pairing record is maintained, and then the display returns to the upper level hierarchy.

When the "YES" is selected

Press and hold the  on the sel switch. The pairing record is reset.

- ③ After resetting, complete pairing while the Bluetooth® indicator flashing by operated the application on your smartphone.

▶ When the display returns to the ordinary display, the Bluetooth® indicator is flashing.

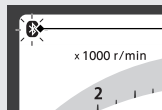

**Bluetooth®
indicator**

- ▶ For operation of the application, follow the instruction of the application.
- ▶ Make a Bluetooth® pairing after stopping at a safe place.

Parking Brake

CMX1100D/D2/D3

Parking brake lever and Release button

Be sure the parking brake is applied while parking and warming up the engine.

- ▶ Make sure the parking brake lever is released before riding.

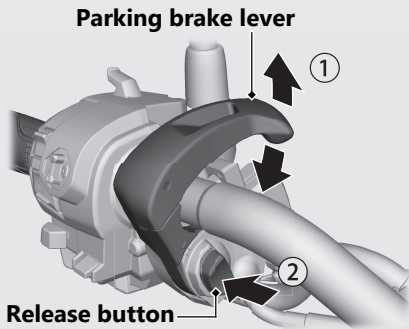

Locking

Pull the parking brake lever back to lock the rear wheel.

- ▶ Be sure the release button pops out and the parking brake lever is not released.
- ▶ The parking brake lock will not function if the parking brake is not adjusted properly.

➔ P.155

Unlocking

Release the parking brake lever by lightly pulling in the lever (①) and pressing the release button (②).

- ▶ Before riding, check that the parking brake indicator is turned off and make sure that the parking brake is fully released so there is no drag on the rear wheel.

NOTICE

Riding with the parking brake applied will damage the rear brake components.

Riding mode

You can change the riding mode.
The riding mode consists of the following parameters.

The level of each parameter changes according to the selected riding mode.

P: Engine output level

EB: Engine brake level

D: **CMX1100D/D2/D3 only** DCT level

T: Torque Control level

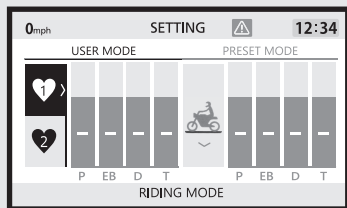

Riding mode has five modes.

Available riding mode: STANDARD, SPORT, RAIN, USER 1 and USER 2.

STANDARD, SPORT and RAIN





- ▶ **STANDARD:** Standard, all-around mode for a variety of situations.
- ▶ **SPORT:** This mode is suitable for sports riding. You can feel the highest engine response.
- ▶ **RAIN:** Good for stable riding on slippery surfaces such as rainy conditions.

These levels cannot be changed.

USER 1 and USER 2

Each value of initial setting can be changed.

Initial setting

	P level	EB level	D level ^{*3}	T level
STANDARD				
	2	2	2	2
SPORT				
	3	2	3	1
RAIN				
	1	1	1	3
USER 1				
	2 ^{*1}	2 ^{*1}	2 ^{*1}	2 ^{*1,2}
USER 2				
	2 ^{*1}	2 ^{*1}	2 ^{*1}	2 ^{*1,2}

Notes:

*1 : Level can be changed.

*2 : If off is selected, the level will change to 2 the next time the ignition is turned on.

*3 : CMX1100D/D2/D3 only

Riding mode *(Continued)*

P level (Engine output level)

P level has three setting levels.

Available setting range: 1 to 3

- ▶ Level 1 has the least power.
- ▶ Level 3 has the most power.

EB level (Engine brake level)

EB level has three setting levels.

Available setting range: 1 to 3

- ▶ Level 1 has the weakest engine braking effect.
- ▶ Level 3 has the strongest engine braking effect.

D level (DCT level)

CMX1100D/D2/D3 only

D level has three setting levels.

Available setting range: 1 to 3

- ▶ Level 1 has the lowest engine revolution.
- ▶ Level 3 has the highest engine revolution.

T level (Torque control level)

T level has three setting levels or can be turned off.

Available setting range: 1 to 3, or Off

- ▶ Level 1 is the minimum Torque Control level.
- ▶ Level 3 is the maximum Torque Control level.
- ▶ Off deactivates the Torque Control.
- ▶ If the electrical system is turned from off to on while the T level is set to Off, the T level is automatically set to 2.

Selecting the riding mode

- 1 Stop the vehicle.
- 2 Press the **MODE** switch with the throttle fully closed.

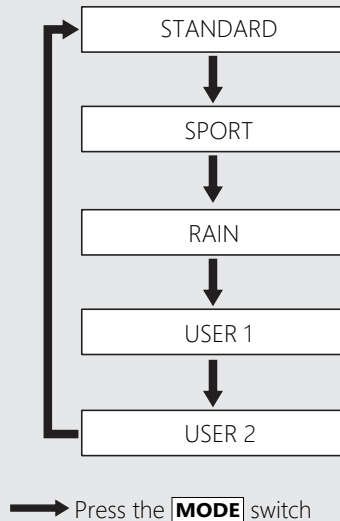
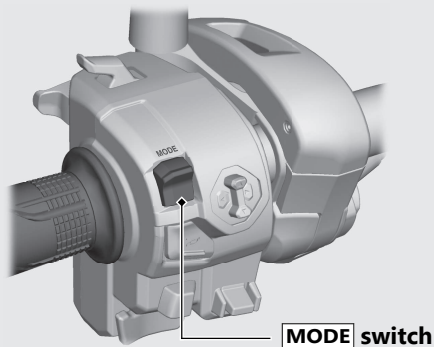

Riding mode *(Continued)*

Setting the riding mode

You can change the P, T, EB, and D (CMX1100D/D2/D3 only) levels of the USER riding mode.

- 1 Stop the vehicle.
- 2 Select the USER 1 or USER 2 riding mode. **→P.97**
- 3 Press and hold the **MODE** button until the parameter setting is displayed in the selectable area.

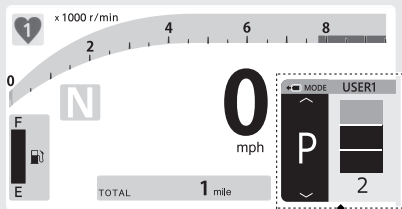

- 4 Select the desired parameter and setting level.
 - ▶ To select the parameter, push the sel switch in the direction of ▲ or ▼.
 - ▶ Press ◀ on the sel switch to select the setting level using ▲ or ▼ on the sel switch.
 - ▶ T level can be changed to 0 (off) by pressing and holding ▲ on the sel switch while selecting the T parameter.
- 5 Press and hold the **MODE** button until the parameter setting is hidden in the selectable area.

You can also change the levels on the USER riding mode in the setting mode of the instruments. **→P.50** **→P.55**

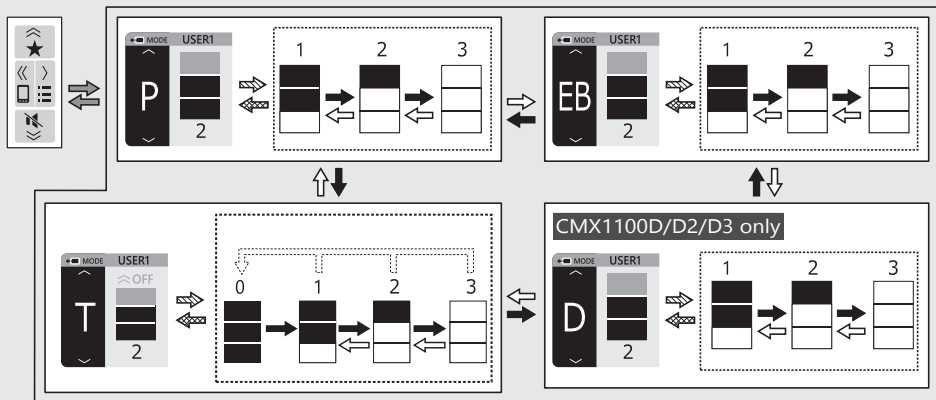

- Press and hold the **MODE** switch
- Push the sel switch in the direction of
- Push the sel switch in the direction of
- Press on the sel switch
- Press on the sel switch
- Press and hold on the sel switch

Starting the Engine

CMX1100A/A2

Start your engine using the following procedure, regardless of whether the engine is cold or warm.

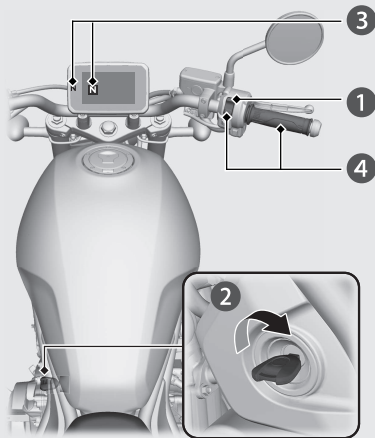

NOTICE

- If the engine does not start within 5 seconds, turn the ignition switch to the OFF position and wait 10 seconds before trying to start the engine again to recover battery voltage.
- Extended fast idling and revving the engine can damage the engine and the exhaust system.

- 1 Make sure the engine stop switch is in the  (Run) position.
- 2 Turn the ignition switch to the ON position.
- 3 Shift the transmission to Neutral (**N** indicator comes on). Alternatively, pull in the clutch lever to start your vehicle while the transmission is in gear as long as the side stand is raised.
- 4 Press the start button with the throttle completely closed.

If you cannot start the engine:

With the throttle slightly open (about 1/8 in [3 mm], without freeplay), press the start button.

About 1/8 in (3 mm), without freeplay

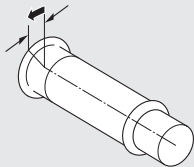
**If the engine does not start:**

- ① Open the throttle fully and press the start button for 5 seconds.
 - ▶ The engine will not start at this time. (When the throttle is fully open, the engine will not start when the start button is pressed.) Release the throttle and start button after 5 seconds and proceed to step ②.
- ② Repeat the normal starting procedure.
- ③ If the engine starts, open the throttle slightly if idling is unstable.
- ④ If the engine does not start, wait 10 seconds before trying steps ① & ② again.

If Engine Will Not Start ➡ P.167

Starting the Engine *(Continued)*

CMX1100D/D2/D3

Start your engine using the following procedure, regardless of whether the engine is cold or warm.

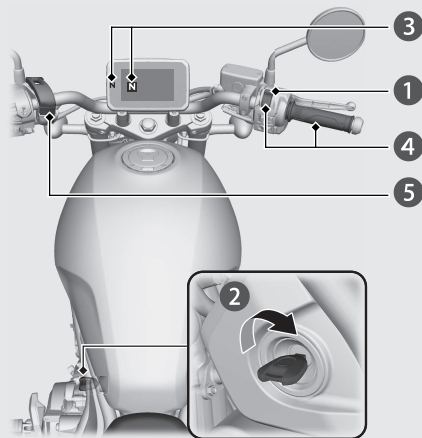

NOTICE

- If the engine does not start within 5 seconds, turn the ignition switch to the OFF position and wait 10 seconds before trying to start the engine again to recover battery voltage.
- Extended fast idling and reving the engine can damage the engine and the exhaust system.

- 1 Make sure the engine stop switch is in the  (Run) position.
- 2 Turn the ignition switch to the ON position.
- 3 Check the transmission is in Neutral (**N** indicator comes on).
- 4 Press the start button with the throttle completely closed.
- 5 Make sure the parking brake lever is released before riding. ➔ P.93

| If you cannot start the engine ➔ P.101

| If Engine Does Not Start ➔ P.101

When you stop the engine

- ① To stop the engine, shift the transmission to Neutral (**N** indicator comes on).
 - ▶ If you turn the ignition switch to the OFF position when the vehicle is in gear, the engine will shut off with the clutch disengaged.
- ② Turn the ignition switch to the OFF position.
- ③ Set the parking brake when you park the vehicle.  **P.93**

Shifting Gears

CMX1100A/A2

Your vehicle transmission has 6 forward gears in a one-down, five-up shift pattern.

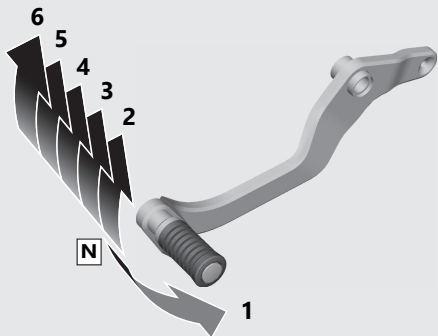

If you put the vehicle in gear with the side stand down, the engine will shut off.

Recommended Shift Points

Shifting Up

From 1st to 2nd	12 mph (20 km/h)
From 2nd to 3rd	19 mph (30 km/h)
From 3rd to 4th	25 mph (40 km/h)
From 4th to 5th	31 mph (50 km/h)
From 5th to 6th	37 mph (60 km/h)

Shifting Down

From 6th to 5th	28 mph (45 km/h)
From 5th to 4th	22 mph (35 km/h)
From 4th to 3rd	16 mph (25 km/h)

NOTICE

Improper shifting can damage the engine, transmission, and drive train. Also, coasting or towing the vehicle for long distances with the engine off can damage the transmission.

CMX1100D/D2/D3

Your vehicle is equipped with an automatically controlled 6-speed transmission. It can be shifted automatically (by AT MODE) or manually (by MT MODE).

Recommended Shift Points**Shifting Up**

From 1st to 2nd	12 mph (20 km/h)
From 2nd to 3rd	19 mph (30 km/h)
From 3rd to 4th	25 mph (40 km/h)
From 4th to 5th	31 mph (50 km/h)
From 5th to 6th	37 mph (60 km/h)

Shifting Down

From 6th to 5th	28 mph (45 km/h)
From 5th to 4th	23 mph (37 km/h)
From 4th to 3rd	20 mph (32 km/h)

NOTICE

Improper shifting can damage the engine, transmission, and drive train. Also, coasting or towing the vehicle for long distances with the engine off can damage the transmission.

Shifting Gears *(Continued)*

Dual Clutch Transmission

CMX1100D/D2/D3

In order to respond to rider demands in a broad range of situations, the transmission is equipped with two operating modes, AT MODE (D) (automatic shift for regular operation); and MT MODE (M) (for 6-speed manual operation), which delivers the same shift feel as a manual transmission.

- ▶ When the vehicle is in gear (gear position number is displayed), be careful not to open the throttle when pushing or pulling the vehicle back and forth or when turning the handlebar while stationary or at low speeds. If you do so, you may cause the vehicle to unexpectedly and strongly surge forward and lose control.
- ▶ Always use the recommended tires and sprockets to ensure correct Dual Clutch Transmission operation.

The Dual Clutch Transmission system runs a self check immediately after starting the engine.

You cannot shift into gear for a few seconds.

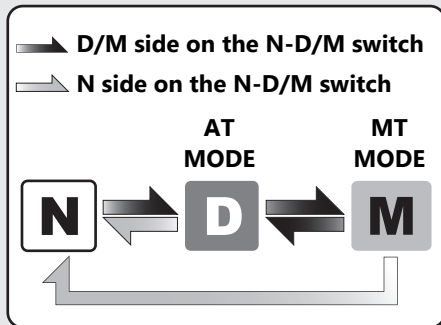

Neutral (N): Neutral is selected automatically when you turn the ignition switch to the ON position.

If neutral is not selected when you turn the ignition switch to the ON position.

- ▶ Turn the ignition switch to the OFF position and then to the ON position again.
- ▶ If neutral is still not selected after turning the ignition switch to the OFF position, and then to the ON position again. **➡ P.172**
You may hear (click) noises when the transmission shifts to Neutral (N). This is normal.

When you can change between N and D

- ▶ Vehicle is stopped and the engine is idling.
- ▶ Side stand is raised.
- ▶ Throttle is completely closed. It is not possible to change from Neutral to D mode while the throttle is applied.
- ▶ You cannot change between N and D mode while the wheels are rotating.

NOTICE

To prevent clutch damage, do not use the throttle to keep the vehicle stopped uphill.

Shifting Gears *(Continued)*

AT MODE: In this mode, the gears are shifted automatically according to your riding conditions.

And also using the shift up switch (+) or shift down switch (-), you can temporarily shift up or down. These switches are convenient when you want to temporarily down-shift in front of a curve, etc. ➡ **P.110**

You can change the D level when you need more power in AT MODE, such as when overtaking, climbing hills, or pulling away. Higher engine RPM can be used by increasing the level.

The D level can be changed only when the riding mode is USER.

To change the D level : ➡ **P.55** ➡ **P.98**

Riding mode : ➡ **P.94**

MT MODE (6-speed manual operation):

In this mode, you can choose between 6 gears.

Changing between Neutral and AT MODE/MT MODE

Changing from Neutral (N) to AT MODE

Press the D/M side on the N-D/M switch (1).

"1" is shown (2) in the gear position indicator and first gear is selected.

Changing between AT MODE and MT MODE

Press the D/M side on the N-D/M switch (3).

The M indicator comes on (4) while MT MODE is selected.

Changing from AT or MT MODE to Neutral

Press N side on the N-D/M switch (5).
"N" is shown (6) in the gear position indicator.

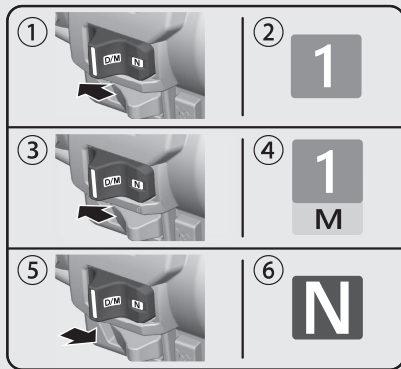
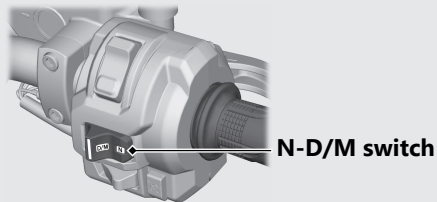

Shifting Gears *(Continued)*

Riding in MT MODE

Shift up and down with the shift up switch (+) and shift down switch (-).

The selected gear is shown on the gear position indicator.

- ▶ If the MT MODE is selected, the transmission does not shift up automatically. Do not allow the engine revs to go into the red zone.
- ▶ The transmission automatically shifts down when you slow down, even in MT MODE.
- ▶ You will start from 1st gear even if MT MODE is selected.

Gear shift operation

Shifting Up:

Press the shift up switch (+) (7).

Shifting Down:

Press the shift down switch (-) (8).

You cannot continue shifting gear by keeping the shift switch pressed.

To continue shifting gear release the switch and press it again.

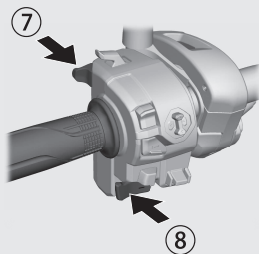

Shift Limit

You cannot downshift if the engine will exceed the rev limit.

Cruise Control

The cruise control system allows you to maintain a steady speed within a specified range.

The available speed setting range and operating gears are listed below:

CMX1100A/A2

Available Speed setting range	30 - 100 mph (50 – 160 km/h)
Operating gear	From 4th to 6th gear

CMX1100D/D2/D3

Available Speed setting range	30 - 100 mph (50 – 160 km/h)
Operating gear	From 3rd to 6th gear

When cruise control is on, your speed will still vary slightly, particularly when going up and down hills.

Cruise control is intended for use only on straight, uncongested highways. Do not use cruise control on city streets, winding roads, during bad weather, or at any other time when you need total control of the throttle.

WARNING

Improper use of the cruise control can lead to a crash in which you could be seriously hurt or killed.

Use the cruise control only when travelling on open highways in good weather.

Cruise Control *(Continued)*

To Set Cruise Control

- 1 Make sure the travelling speed and operating gear are conformed to the requirements of the system.
 - ▶ Any speed other than the available range will not be memorized.
- 2 Press the  cruise control main switch (The cruise control display will be appeared).
- 3 Accelerate to the desired speed.
- 4 Push the cruise control lever to **SET / -** side (The cruise control main indicator color will be changed).
 - ▶ The current travelling speed is memorized, and then the set speed is displayed on the display.

Cruise control display

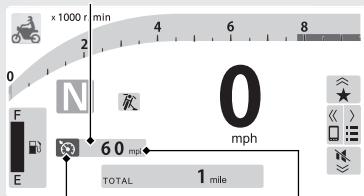



Cruise control main indicator

Cruise control set speed

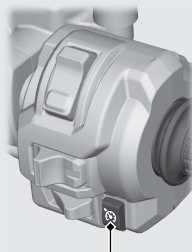

RES / + SET / -
Cruise control lever



 **Cruise control main switch**

| To Change the Set Speed To Fine Tune the Set Speed

- 1 To increase the set speed: tap the cruise control lever to **RES / +** side.
To decrease the set speed: tap the cruise control lever to **SET / -** side.
- 2 The set speed is displayed in the display.

Each quick tap (brief push and release) on either side will change your speed by 1 mph or 1 km/h (depending on the mileage meter set unit).

Any speed other than the possible setting range will not be indicated (stops at the upper or lower limit of the available speed setting range).

To Change the Set Speed Continuously

- To increase the set speed: push and hold the cruise control lever to **RES / +** side. The system will accelerate your vehicle automatically. When you reach the desired speed, release the cruise control lever.

If the cruise control lever is pushed and held to **RES / +** side continuously, the set speed indicated in the display will stop at the upper limit of the available speed setting range.

- To decrease speed: push and hold the cruise control lever to **SET / -** side. The system will automatically slow your vehicle. When you reach the desired speed, release the cruise control lever.

Cruise Control *(Continued)*

If the cruise control lever is pushed and held to **SET / -** side continuously, the set speed indicated in the display will stop at the lower limit of the available speed setting range.

To Manually Increase the Set Speed

- ① Use the throttle to accelerate until you reach the desired speed.
- ② Push and release the cruise control lever to **SET / -** side.
 - ▶ Cruise control set speed is set to the travelling speed when cruise control lever is released.

To Manually Increase Vehicle Speed

- ① Use the throttle in the normal manner to accelerate.
- ② To return to the set speed, close the throttle and coast without applying the brakes.
 - ▶ The cruise system will maintain the speed you previously set.

To Cancel Cruise Control

To Disengage the System

- Press the cruise control main switch (The cruise control display disappears, and the set speed will be erased from memory).

To Temporarily Disengage the System

- 1 Perform one of the following operations to disengage the system temporarily (The color of  cruise control main indicator temporarily goes off but the set speed remains in memory).
 - Apply the brake lever or pedal.
 - Rotate the throttle grip past the automatically closed position in the deceleration direction.
 - **CMX1100A/A2**
Disengage the clutch or operate the shift pedal.
- 2 To resume cruise control:
 - If you are still traveling over 30 mph (50 km/h), push and release the cruise control lever to **RES / +** side.
 - If you are traveling under 30 mph (50 km/h), use the throttle to increase road speed above 30 mph (50 km/h), and then push and release the cruise control lever to **RES / +** side.

Refueling

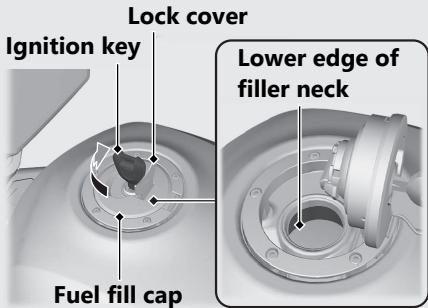

Do not fill with fuel above the lower edge of the filler neck.

Fuel type: Unleaded gasoline only

Recommended fuel octane number:

Pump Octane Number (PON) 86 or higher.

Tank capacity: 3.59 US gal (13.6 L)

Refueling and Fuel Guidelines ➔ P.15

Opening the Fuel Fill Cap

Open the lock cover, insert the ignition key, and turn it clockwise to open the fuel fill cap.

Closing the Fuel Fill Cap

- 1 After refueling, push the fuel fill cap closed until it locks.
- 2 Remove the ignition key and close the lock cover.
 - ▶ The ignition key cannot be removed if the fuel fill cap is not locked.

⚠ WARNING

Gasoline is highly flammable and explosive. You can be burned or seriously injured when handling fuel.

- Stop the engine, and keep heat, sparks, and flames away.
- Only handle fuel outdoors.
- Wipe up spills immediately.

USB Socket

Your vehicle is equipped with a USB socket (for USB Type-C only).

The USB socket is located behind the left side of the meter.

This socket is for battery charging only.

Use USB devices at your own risk.

In no event shall Honda be liable for any damage to your USB device when in use.

Only USB devices within the following specifications can be connected.

USB Type-C rated capacity:

15 W (5 V, 3.0 A)

To connect your USB device

- 1 Remove the cap from the USB socket cover.
 - ▶ Cap can be set on the USB socket cover.

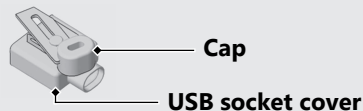
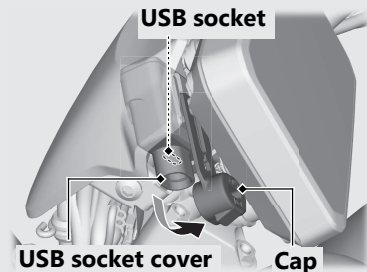

- 2 Connect a certified USB cable to the USB socket.

USB Socket *(Continued)*

- ▶ To prevent the battery from becoming weak (or dead), keep the engine running while drawing current from the socket.
- ▶ To prevent entry of foreign matter into the socket, be sure to install a cap on the USB socket cover.
- ▶ Carefully secure all connected devices, as vibration may cause damage to them or they could shift unexpectedly.

NOTICE

- Using any heat-generating USB devices or improperly rated USB devices can damage the socket.
- Do not use the USB socket in wet conditions, when or while washing or any other wet conditions as these will damage the USB socket.
- Do not allow the USB cable to become pinched or trapped.
- Do not allow the USB cable to interfere with the steering or controls.

Storage Equipment

Tool/Document Bag

The tool kit and document bag are located under the seat by the rubber strap.

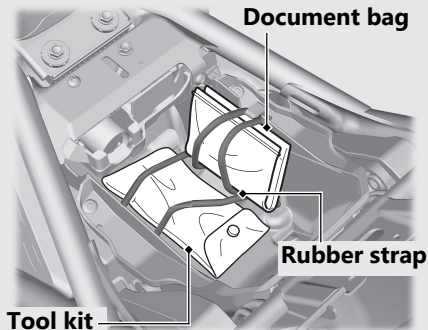

Removing the Seat  P.147

Storage Equipment *(Continued)*

Helmet Holder

The helmet holders are located on the underside of the seat.

- ▶ Use the helmet holder only when parked.

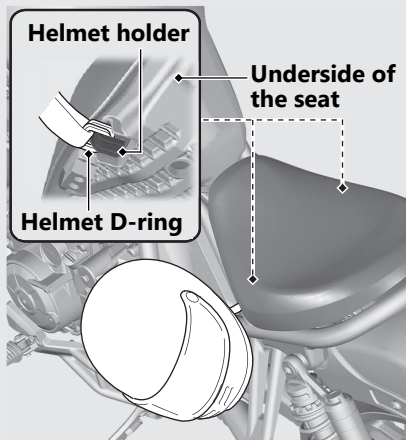

Removing the Seat P.147

WARNING

Riding with a helmet attached to the holder can interfere with your ability to safely operate the vehicle and could lead to a crash in which you can be seriously hurt or killed.

Use the helmet holder only while parked. Do not ride with a helmet secured by the holder.

Saddle Bag

CMX1100A2/D2

Never exceed the maximum weight capacity.

Maximum weight: 11.0 lb (5.0 kg)

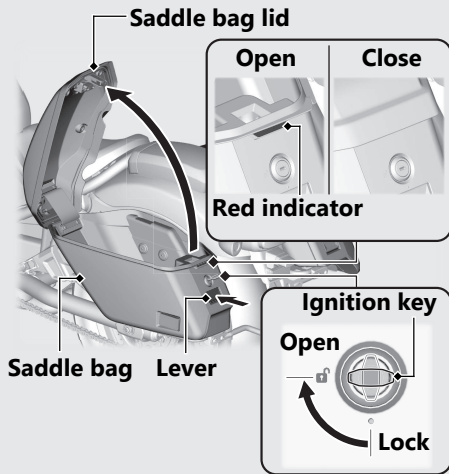

Opening the Saddle bag

The right and left saddle bags can be opened in the same manner.

- ① Insert the ignition key, and turn it clockwise.
- ② Push the lever.
- ③ Open the saddle bag lid.

Closing the Saddle bag

- ① Push down on the lid until it firmly closes.
- ② Turn the ignition key to the lock position and remove the ignition key.

After closing the saddle bag lid, ensure it is securely closed by lightly pulling up the lid. Before riding, always make sure the red indicator is fully covered and that the saddle bag is closed.

- ▶ Do not store valuables or fragile articles.
- ▶ The saddle bags are not perfectly waterproof, and water may enter when washing the vehicle, when it rains, etc.
- ▶ Load weight equally on both sides to minimize imbalance.

Maintenance

Please read "Importance of Maintenance" and "Maintenance Fundamentals" carefully before attempting any maintenance. Refer to "Specifications" for service data.

An optional larger tool kit may be available.

Check with your Honda dealer's parts department.

Importance of Maintenance	P. 123	Drive Chain	P. 158
Maintenance Schedule	P. 125	Clutch	P. 159
Maintenance Record	P. 128	Throttle	P. 162
Maintenance Fundamentals	P. 129	Other Adjustments	P. 163
Removing & Installing Body		Adjusting the Brake Lever	P. 163
Components	P. 144	Adjusting the Front Suspension	P. 164
Battery	P. 144	Adjusting the Rear Suspension.....	P. 165
Clip.....	P. 146		
Seat.....	P. 147		
Side Cover.....	P. 148		
Engine Oil	P. 149		
Coolant	P. 151		
Brakes	P. 153		
Side Stand	P. 157		

Importance of Maintenance

Importance of Maintenance

Keeping your vehicle well-maintained is absolutely essential to your safety and to protect your investment, obtain maximum performance, avoid breakdowns, and reduce air pollution. Maintenance is the owner's responsibility. Be sure to inspect your vehicle before each ride and perform the periodic checks specified in the Maintenance Schedule.

➔ P. 125

⚠ WARNING

Improperly maintaining your vehicle or failing to correct a problem before you ride can cause a crash in which you can be seriously hurt or killed.

Always follow the inspection and maintenance recommendations and schedules in this owner's manual.

For information about the exhaust emission and noise emission requirements of the U.S. Environmental Protection Agency (EPA), the California Air Resources Board (CARB), and the Environment and Climate Change Canada (ECCC). ➔ P. 194

USA

Maintenance, replacement or repair of the emission control devices and systems may be performed by any vehicle repair establishment or individual using parts that are "certified" to EPA standards.

Maintenance Safety

Always read the maintenance instructions before you begin each task and make sure that you have the tools, parts, and skills required. We cannot warn you of every conceivable hazard that can arise in performing maintenance. Only you can decide whether or not you should perform a given task.

Follow these guidelines when performing maintenance.

- Stop the engine and remove the key.
- Place your vehicle on a firm, level surface using the side stand or a maintenance stand to provide support.
- Allow the engine, muffler, brakes, and other high-temperature parts to cool before servicing as you can get burned.
- Run the engine only when instructed, and do so in a well-ventilated area.

Maintenance Schedule



























































The maintenance schedule specifies the maintenance requirements necessary to ensure safe, dependable performance, and proper emission control.

Maintenance work should be performed in accordance with Honda's standards and specifications by properly trained and equipped technicians. Your dealer meets all of these requirements. All scheduled maintenance is considered a normal owner operating cost and will be charged to you by your dealer. Keeping an accurate maintenance record will help ensure your vehicle is properly maintained.



➤ P. 128

Make sure whoever performs the scheduled maintenance completes the maintenance record. Retain all service documents. If you sell your vehicle, these service documents should be transferred with the vehicle to the new owner.

Maintenance Schedule

Items			Frequency*1								Regular Replace	Refer to page
			× 1,000 mi	0.6	4	8	12	16	20	24		
			× 1,000 km	1.0	6.4	12.8	19.2	25.6	32.0	38.4		
 Fuel Line											-	
 Throttle Operation											162	
 Air Cleaner*2											-	
 Crankcase Breather*3											-	
 Spark Plug		Every 16,000 mi (25,600 km):  Every 32,000 mi (51,200 km): 									-	
 Valve Clearance											-	
 Engine Oil										1 Year	-	
 Engine Oil Filter											-	
 Clutch Oil Filter*6											-	
 Engine Idle Speed											-	
 Radiator Coolant*5										3 Years	151	
 Cooling System											-	
 Secondary Air Supply System											-	
 Evaporative Emission Control System*4											-	





Maintenance Level



























































-  : Intermediate. We recommend service by your dealer, unless you have the necessary tools and are mechanically skilled. Procedures are provided in an official Honda Service Manual (➔ P. 201).
-  : Technical. In the interest of safety, have your vehicle serviced by your dealer.

Emission-Related Maintenance

 : Emission-Related Items

Maintenance Legend

-  : Inspect (clean, adjust, lubricate, or replace, if necessary)
-  : Replace
-  : Lubricate
-  : Clean

Items	Frequency*1										Regular Replace	Refer to page
	× 1,000 mi	0.6	4	8	12	16	20	24	Regular Replace	Refer to page		
	× 1,000 km	1.0	6.4	12.8	19.2	25.6	32.0	38.4				
Drive Chain	Every 600 mi (1,000 km):  											158
Brake Fluid*5										2 Years	153	
Brake Pads Wear											154	
Brake System											129	
Brake Light Switch											156	
Brake Lock Operation*6											155	
Headlight Aim											–	
Clutch System*7											159	
Side Stand											157	
Suspension											–	
Nuts, Bolts, Fasteners											–	
Wheels/Tires											140	
Steering Head Bearings											–	

Notes:

*1 : At higher odometer reading, repeat at the frequency interval established here.

*2 : Service more frequently when riding in unusually wet or dusty areas.

*3 : Service more frequently when riding in rain or at full throttle.

*4 : 50 STATE (meets California).

*5 : Replacement requires mechanical skill.

*6 : CMX1100D/D2/D3 only

*7 : CMX1100A/A2 only

Maintenance Record

Distance	Odometer	Date	Performed By:	Notes
600 miles (1,000 km)				
4,000 miles (6,400 km)				
8,000 miles (12,800 km)				
12,000 miles (19,200 km)				
16,000 miles (25,600 km)				
20,000 miles (32,000 km)				
24,000 miles (38,400 km)				
28,000 miles (44,800 km)				
32,000 miles (51,200 km)				
36,000 miles (57,600 km)				
40,000 miles (64,000 km)				
44,000 miles (70,400 km)				
48,000 miles (76,800 km)				
52,000 miles (83,200 km)				
56,000 miles (89,600 km)				
60,000 miles (96,000 km)				
64,000 miles (102,400 km)				
68,000 miles (108,800 km)				

Pre-ride Inspection

To ensure safety, it is your responsibility to perform a pre-ride inspection and make sure that any problem you find is corrected. A pre-ride inspection is a must, not only for safety, but because having a breakdown, or even a flat tire, can be a major inconvenience.

Check the following items before you get on your vehicle:

- Tire tread wear and air pressures are within limits ➔ P. 140
- Lights, horn, and turn signals operate normally
- Check the condition of the drive chain. Adjust slack and lubricate as needed ➔ P. 137

USA model (Model not equipped with Optional Passenger Seat Kit)

Check the following items if you are carrying cargo:

Canada model and USA model equipped with Optional Passenger Seat Kit

Check the following items if you are carrying a passenger or cargo:

- Combined weight is within load limits ➔ P. 209
- Cargo is secured properly
- Suspension is adjusted to suit load ➔ P. 164 ➔ P. 165

Check the following items after you get on your vehicle:

- Throttle action moves smoothly without binding ➔ P. 162
- Brake lever and pedal operate normally
- Check the fuel level and refuel when needed ➔ P. 15, ➔ P. 116
- Engine stop switch functions properly ➔ P. 84

Maintenance Fundamentals

Check the following items at regular intervals:

- Oil level is between the upper and lower level marks ➤ P. 149
- Brake fluid level:
Front: above the LOWER level mark ➤ P. 153
Rear: between the UPPER and LOWER level marks ➤ P. 153
- Engine coolant level is between the UPPER and LOWER level marks ➤ P. 151
- Side stand functions properly ➤ P. 157
- **CMX1100D/D2/D3**
Parking brake works properly ➤ P. 155

Periodic Checks

You should also perform other periodic maintenance checks at least once a month regardless of how often you ride, or more often if you ride frequently.

Also, check the odometer reading against the Maintenance Schedule and perform all maintenance that is due. ➤ P. 125

Tires and wheels	Check the air pressure (➤ P. 140), examine tread for wear and damage (➤ P. 140), and check the wheels for damage.
Fluid levels	Check the engine oil level (➤ P. 149), engine coolant level (➤ P. 151), and brake fluid level (➤ P. 153).
Lights	Check that the headlight, brake light, taillight, license plate light, turn signals, and position lights are working properly.
Controls	Check the freeplay of the clutch lever (CMX1100A/A2 only) (➤ P. 159), throttle grip (➤ P. 162), front brake lever (➤ P. 163), rear brake pedal and parking brake (CMX1100D/D2/D3 only) (➤ P. 155) operate properly.
Drive chain	Check the slack (➤ P. 158), adjust the slack, and lubricate (➤ P. 138) as needed.
Fuses	Check that you have a full supply of spare fuses.
Nuts & bolts	Check the major nuts and bolts, and tighten as needed.

Replacing Parts

Always use Honda Genuine Parts or their equivalents to ensure reliability and safety. When ordering colored components, specify the model name, color, and code mentioned on the color label.

The color label is attached to the utility box under the seat. ➤ P. 147

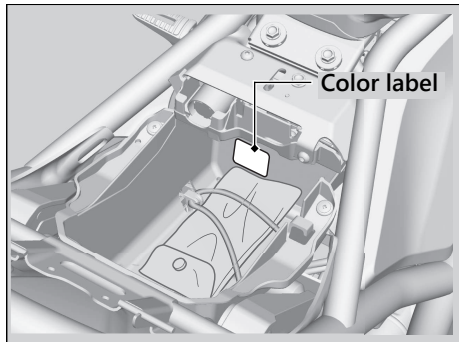

⚠️ WARNING

Installing non-Honda parts may make your vehicle unsafe and cause a crash in which you can be seriously hurt or killed.

Always use Honda Genuine Parts or equivalents that have been designed and approved for your vehicle.

Battery

Your vehicle has a maintenance-free type battery. You do not have to check the battery electrolyte level or add distilled water. Clean the battery terminals if they become dirty or corroded.

Do not remove the battery cap seals. There is no need to remove the cap when charging.



This symbol on the battery means that this product must not be treated as household waste.

NOTICE

An improperly disposed of battery can be harmful to the environment and human health. Always confirm local regulations for proper battery disposal instruction.

What to do in an emergency

If any of the following occur, immediately see your doctor.

- Electrolyte splashes into your eyes:
 - ▶ Wash your eyes repeatedly with cool water for at least 15 minutes. Using water under pressure can damage your eyes.
- Electrolyte splashes onto your skin:
 - ▶ Remove affected clothing and wash your skin thoroughly using water.
- Electrolyte splashes into your mouth:
 - ▶ Rinse mouth thoroughly with water, and do not swallow.

⚠ WARNING

The battery gives off explosive hydrogen gas during normal operation.

A spark or flame can cause the battery to explode with enough force to kill or seriously hurt you.

Wear protective clothing and a face shield, or have a skilled mechanic do the battery servicing.

WARNING: Battery posts, terminals, and related accessories contain lead and lead compounds.

Wash your hands after handling.

| Cleaning the Battery Terminals

1. Remove the battery. ➤ P. 144
2. If the terminals are starting to corrode and are coated with a white substance, wash with warm water and wipe clean.
3. If the terminals are heavily corroded, clean and polish the terminals with a wire brush or sandpaper. Wear safety glasses.

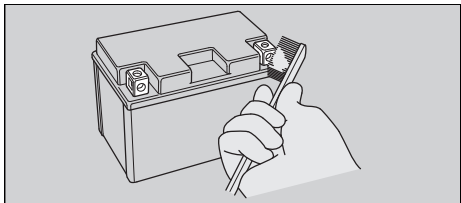

4. After cleaning, reinstall the battery.

The battery has a limited life span. Consult your dealer about when you should replace the battery. Always replace the battery with another maintenance-free battery of the same type.

| Charging

If you use electrical accessories that drain the battery or you do not ride frequently, we recommend that you charge the battery every 30 days using a charger designed specifically for your Honda, which can be purchased from your dealer. Read the information that came with your battery charger and follow the instructions on the battery. Avoid using an automobile-type battery charger, as these can overheat a motorcycle battery and cause permanent damage.

Make sure the ignition switch is in the OFF position before charging the battery.

NOTICE

Improper charging can damage the battery. If you can't charge the battery or it appears unable to hold a charge, contact your dealer.

NOTICE

Jump starting using an automobile battery can damage your vehicle's electrical system and is not recommended. Bump starting is also not recommended.

NOTICE

Installing non-Honda electrical accessories can overload the electrical system, discharging the battery and possibly damaging the system.

Fuses

Fuses protect the electrical circuits on your vehicle. If something electrical on your vehicle stops working, check for and replace any blown fuses. ➤ P. 179

Inspecting and Replacing Fuses

Turn the ignition switch to the OFF position to remove and inspect fuses. If a fuse is blown, replace with a fuse of the same rating. For fuse ratings, see "Specifications." ➤ P. 212

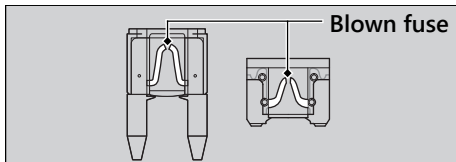
**NOTICE**

Replacing a fuse with one that has a higher rating greatly increases the chance of damage to the electrical system.

If a fuse fails repeatedly, you likely have an electrical fault. Have your vehicle inspected by your dealer.

Engine Oil

Engine oil consumption varies and oil quality deteriorates according to riding conditions and time elapsed.

Check the engine oil level regularly, and add the recommended engine oil if necessary. Dirty oil or old oil should be changed as soon as possible.

Selecting the Engine Oil

For recommended engine oil, see "Specifications." ▣ P. 211

If you use non-Honda engine oil, check the label to make sure that the oil satisfies all of the following standards:

- JASO T 903 standard^{*1}: MA
- SAE standard^{*2}: 10W-30
- API classification^{*3}: SJ or higher

- ^{*1}. The JASO T 903 standard is an index for engine oils for 4-stroke motorcycle engines. There are two classes: MA and MB. For example, the following label shows the MA classification.

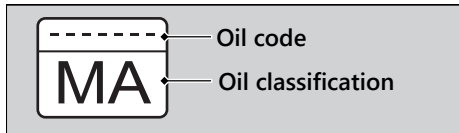

- ^{*2}. The SAE standard grades oils by their viscosity.
- ^{*3}. The API classification specifies the quality and performance rating of engine oils. Use SJ or higher oils, excluding oils marked as "Energy Conserving" or "Resource Conserving" on the circular API service symbol.

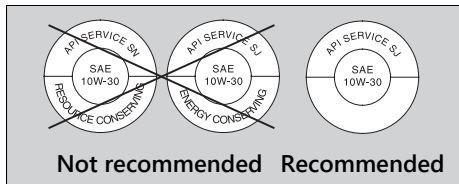

Brake Fluid

Do not add or replace brake fluid, except in an emergency. Use only fresh brake fluid from a sealed container. If you do add fluid, have the brake system serviced by your dealer as soon as possible.

NOTICE

Brake fluid can damage plastic and painted surfaces.
Wipe up spills immediately and wash thoroughly.

Recommended brake fluid:

Honda DOT 4 Brake Fluid or equivalent

⚠ WARNING

Clean filler cap before removing. Use only DOT 4 fluid from a sealed container.

Drive Chain

The drive chain must be inspected and lubricated regularly. Inspect the chain more frequently if you often ride on bad roads, ride at high speed, or ride with repeated fast acceleration. 📄 P. 158

If the chain does not move smoothly, makes strange noises, has damaged rollers, has loose pins, has missing O-rings, or has kinks, have the chain inspected by your dealer.

Also inspect the drive sprocket and driven sprocket. If either has worn or damaged teeth, have the sprocket replaced by your dealer.



**Normal
(GOOD)**



**Worn
(REPLACE)**



**Damaged
(REPLACE)**

NOTICE

Use of a new chain with worn sprockets will cause rapid chain wear.

Cleaning and Lubricating

After inspecting the slack, clean the chain and sprockets while rotating the rear wheel. Use a dry cloth with chain cleaner designed specifically for O-ring chains, or neutral detergent. Use a soft brush if the chain is dirty. After cleaning, wipe dry and lubricate with the recommended lubricant.

Recommended lubricant:

Pro Honda HP Chain Lube or equivalent

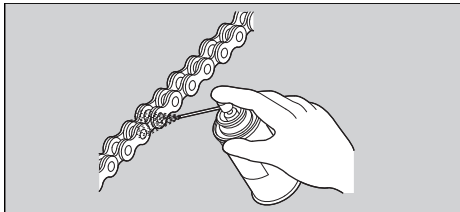

Do not use a steam cleaner, a high pressure cleaner, a wire brush, volatile solvent such as gasoline and benzene, abrasive cleaner, chain cleaner or lubricant NOT designed specifically for O-ring chains as these can damage the rubber O-ring seals.

Avoid getting lubricant on the brakes or tires. Avoid applying excess chain lubricant to prevent spray onto your clothes and the vehicle.

Recommended Coolant

Pro Honda HP Coolant is a pre-mixed solution of antifreeze and distilled water.

Concentration:

50% antifreeze and 50% distilled water

A concentration of antifreeze below 40% will not provide proper corrosion and cold temperature protection.

A concentration of up to 60% will provide better protection in colder climates.

NOTICE

Using coolant not specified for aluminum engines or tap/mineral water can cause corrosion.

Crankcase Breather

Service more frequently when riding in rain, at full throttle, or after the vehicle is washed or overturned. Service if the deposit level can be seen in the transparent section of the drain tube.

If the drain tube overflows, the air filter may become contaminated with engine oil, causing poor engine performance.

Tires (Inspecting/Replacing)

Checking the Air Pressure

Visually inspect your tires and use an air pressure gauge to measure the air pressure at least once a month or any time you think the tires look low. Always check air pressure when your tires are cold.

Even if the direction of the valve stem is changed, do not return it to the original position. Have your vehicle inspected by your dealer.

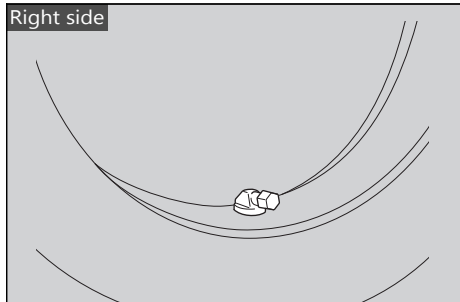

Inspecting for Damage

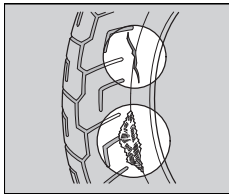

Inspect the tires for cuts, slits, or cracks that expose fabric or cords, or nails or other foreign objects embedded in the side of the tire or the tread.

Also inspect for any unusual bumps or bulges in the side walls of the tires.

Inspecting for Abnormal Wear

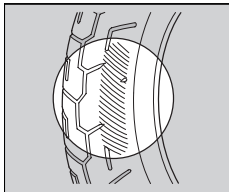

Inspect the tires for signs of abnormal wear on the contact surface.

Inspecting Tread Depth

Inspect the tread wear indicators. If they become visible, replace the tires immediately. For safe riding, you should replace the tires when the minimum tread depth is reached.

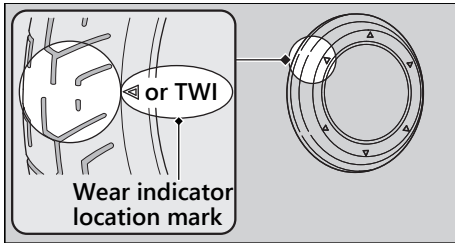

⚠️ WARNING

Riding on tires that are excessively worn or improperly inflated can cause a crash in which you can be seriously hurt or killed.

Follow all instructions in this owner's manual regarding tire inflation and maintenance.

Maintenance Fundamentals

Have your tires replaced by your dealer. For recommended tires, air pressure, and minimum tread depth, see "Specifications."

➤ P. 211

Follow these guidelines whenever you replace tires:

- Use the recommended tires or their equivalents of the same size, construction, speed rating, and load range.
- Have the wheel balanced with Honda Genuine balance weights or equivalent after the tire is installed.
- Do not install a tube inside a tubeless tire on this vehicle. Excessive heat build-up can cause the tube to burst.
- Use only tubeless tires on this vehicle. The rims are designed for tubeless tires, and during hard acceleration or braking, a tube-type tire could slip on the rim and cause the tire to rapidly deflate.

WARNING

Installing improper tires on your vehicle can adversely affect handling and stability, and can cause a crash in which you can be seriously hurt or killed.

Always use the size and type of tires recommended in this owner's manual.

Tire Service Life

The service life of your tires is dependent on many factors, including, but not limited to, riding habits, road conditions, vehicle loading, tire air pressure, maintenance history, speed, and environmental conditions (even when the tires are not in use).

In addition to your regular inspections and maintenance, it is recommended that you have annual inspections performed once the tires reach 5 years old. It is also recommended that all tires be removed from service after 10 years from the date of manufacture, regardless of their condition or state of wear.

The last four digits of the TIN (tire identification number) indicate the date of manufacture.

Tire Identification Number (TIN)

The tire identification number (TIN) is a group of numbers and letters located on the sidewall of the tire.

① ② ③

DOT XXXX XXXX 20 23

DOT: This indicates that the tire meets all requirements of the U.S. Department of Transportation.

- ① XXXX: Factory code
- ② XXXX: Tire type code
- ③ 20 23: Date of manufacture (week & year).
Example: week 20 in year 23.

Tire Labeling Example

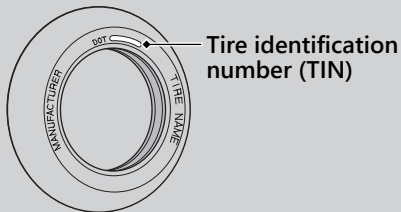

Battery

Removal

Make sure the ignition switch is in the OFF position.

1. Remove the seat, left and right side covers. P. 147, P. 148
2. Remove the utility box by removing the screws.

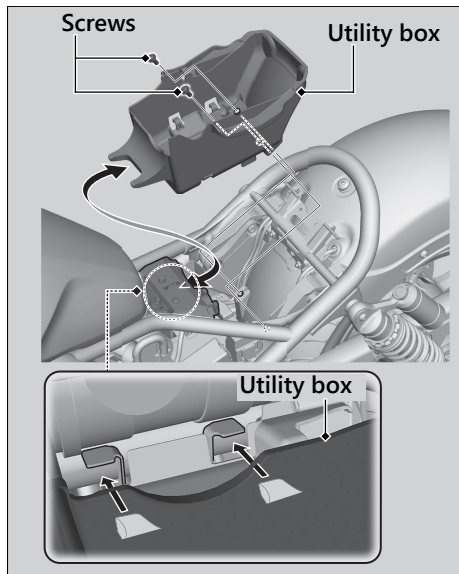

3. Disconnect the negative \ominus terminal from the battery.

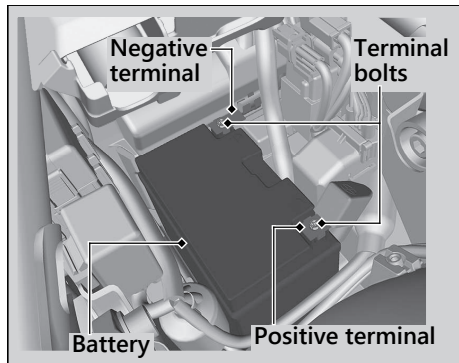

4. Disconnect the positive \oplus terminal from the battery.
5. Remove the battery, taking care not to drop the terminal nuts.
 - Temporarily tighten the terminal bolt to the terminal nut when removing the battery.

Installation

Install the parts in the reverse order of removal. Always connect the positive \oplus terminal first. Make sure bolts and nuts are tight.

Make sure the clock information is correct after the battery is reconnected. ➤ P. 66
 For proper handling of the battery, see "Maintenance Fundamentals." ➤ P. 132
 "Battery Goes Dead." ➤ P. 178

Clip

Removal

1. Remove the pin by a Phillips screwdriver.
2. Pull the clip out of the hole.

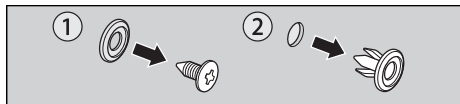

Installation

1. Insert the clip into the hole.
2. Push the pin in.

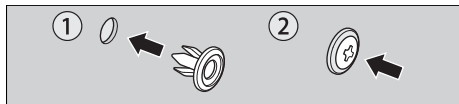

Seat

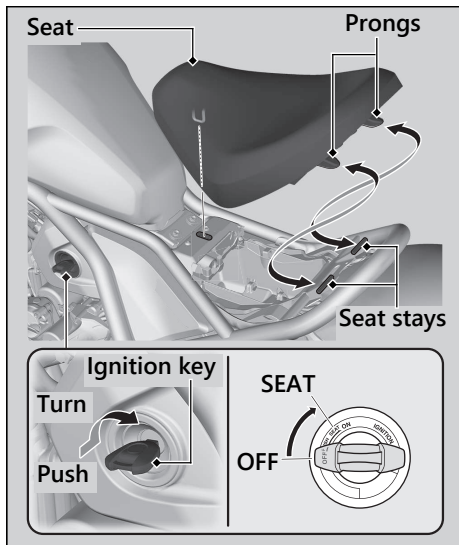

Removal

1. Push the ignition key down, and turn the ignition switch to the SEAT position.
2. Pull the seat up and forward.

Installation

1. Put the prongs under the seat stays.
2. Push the front of the seat backward and lower until it locks.

Make sure that the seat is locked securely in position by pulling it up lightly.

The seat locks automatically when closed. Take care not to lock your key in the compartment under the seat.

Side Cover

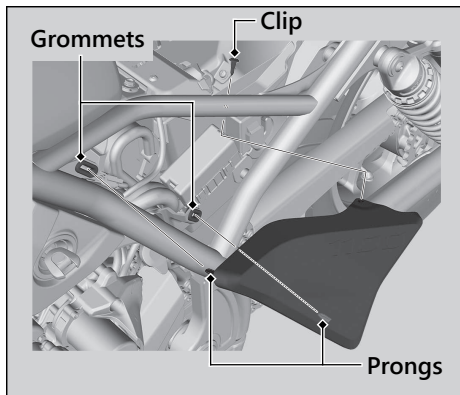

The right and left side covers can be removed in the same way.

Removal

1. Remove the seat. ► P. 147
2. Remove the clip. ► P. 146
3. Remove the prongs from the grommets.
4. Remove the side cover.

Installation

Install the parts in the reverse order of removal.

Checking the Engine Oil

1. If the engine is cold, idle the engine for 3 to 5 minutes.
2. Turn the ignition switch to the OFF position and wait for 2 to 3 minutes.
3. Place your vehicle in an upright position on a firm, level surface.
4. Remove the dipstick and wipe it clean.
5. Insert the dipstick until it seats, but don't screw it in.
6. Check that the oil level is between the upper level and lower level marks on the dipstick.
7. Securely install the dipstick.

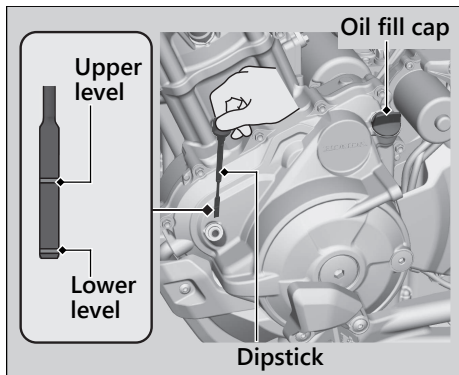

Adding Engine Oil

If the engine oil is below or near the lower level mark, add the recommended engine oil.

► P. 136, ► P. 211

1. Remove the oil fill cap. Add the recommended oil until it reaches the upper level mark.
 - Place your vehicle in an upright position on a firm, level surface when checking the oil level.
 - Do not overfill above the upper level mark.
 - Make sure no foreign objects enter the oil filler opening.
 - Wipe up any spills immediately.
2. Securely reinstall the oil fill cap.

NOTICE

Overfilling with oil or operating with insufficient oil can cause damage to your engine. Do not mix different brands and grades of oil. They may affect lubrication and clutch operation.

For the recommended oil and oil selection guidelines, see “Maintenance Fundamentals.”

► P. 136

Checking the Coolant

Check the coolant level in the reserve tank while the engine is cold.

1. Place your vehicle on a firm, level surface.
2. Hold your vehicle in an upright position.
3. Check that the coolant level is between the UPPER level and LOWER level marks on the reserve tank.

If the coolant level is dropping noticeably or the reserve tank is empty, you likely have a serious leak. Have your vehicle inspected by your dealer.

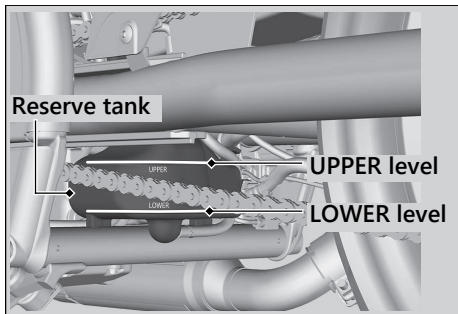

Adding Coolant

If the coolant level is below the LOWER level mark, add the recommended coolant (➔ P. 139) until the level reaches the UPPER level mark.

Add fluid only from the reserve tank cap and do not remove the radiator cap.

Coolant ► Adding Coolant

1. Remove the reserve tank cap and add fluid while monitoring the coolant level.
 - Do not overfill above the UPPER level mark.
 - Make sure no foreign objects enter the reserve tank opening.
2. Securely reinstall the reserve tank cap.

⚠ WARNING

Removing the radiator cap while the engine is hot can cause the coolant to spray out, potentially scalding you.

Always let the engine and radiator cool down before removing the radiator cap.

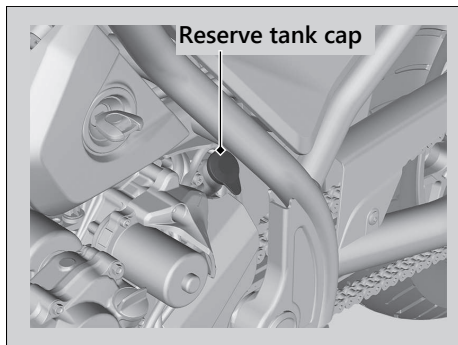

Checking Brake Fluid

1. Place your vehicle in an upright position on a firm, level surface.
2. Check that the brake fluid reservoir is horizontal and that the fluid level is:
Front above the LOWER level mark.
Rear between the LOWER level and UPPER level marks.

If the brake fluid level in either reservoir is below the LOWER level mark or the brake lever and pedal freeplay becomes excessive, inspect the brake pads for wear. If the brake pads are not worn, you most likely have a leak. Have your vehicle inspected by your dealer.

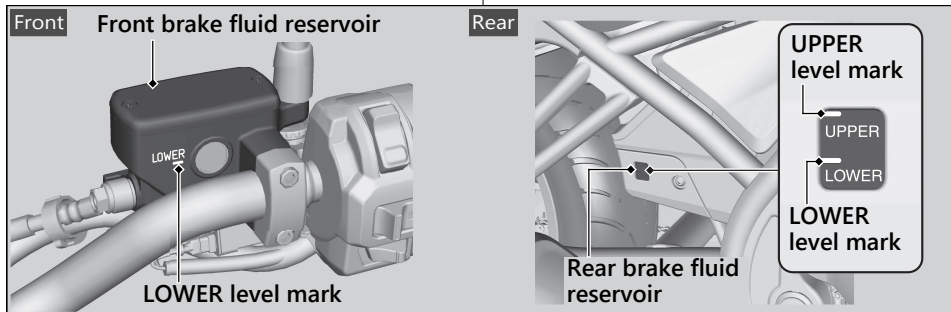

Inspecting the Brake Pads

Check the condition of the brake pad wear indicators.

Front The pads need to be replaced if a brake pad is worn to the bottom of the indicator.

Rear The pads need to be replaced if a brake pad is worn to the indicator.

1. **Front** Inspect the brake pads from below the brake caliper.
2. **Rear** Inspect the brake pads from the rear right of the vehicle.

If necessary, have the pads replaced by your dealer.

Always replace both left and right brake pads at the same time.

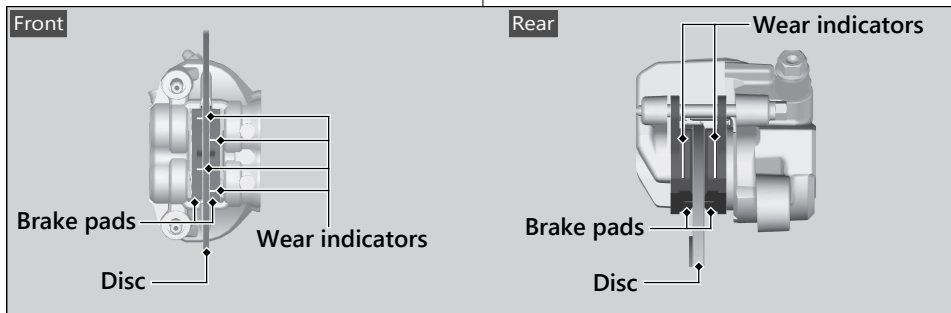

Checking the Parking Brake

CMX1100D/D2/D3

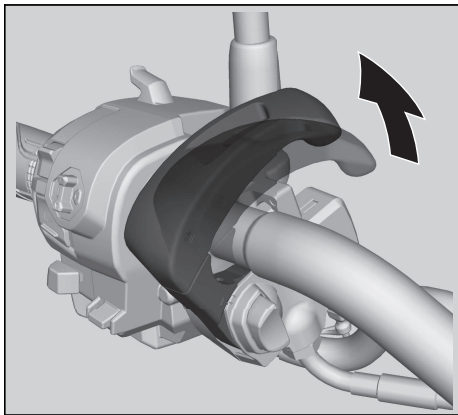

Place your vehicle on a firm, level surface. Stop the engine and push your vehicle while the parking brake is set to check the efficacy of the parking brake.

If the efficacy of the parking brake becomes weak, have the brake adjusted by your dealer.

Adjusting the Brake Light Switch

Check the operation of the brake light switch. Hold the brake light switch and turn the adjusting nut in the direction A if the switch operates too late, or turn the nut in the direction B if the switch operates too soon.

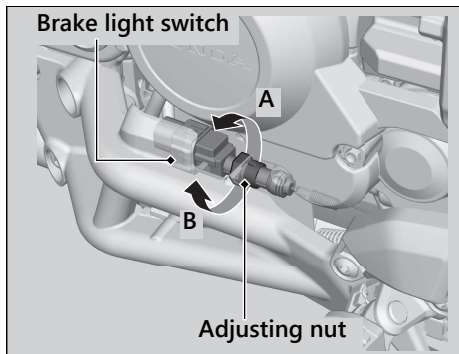

Checking the Side Stand

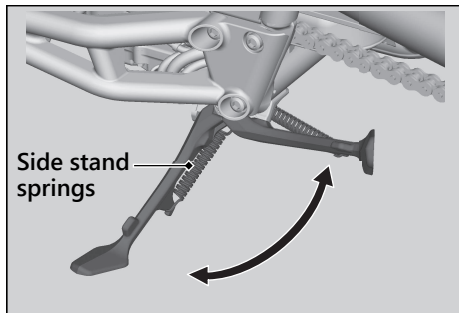

1. Check that the side stand operates smoothly. If the side stand is stiff or squeaky, clean the pivot area and lubricate the pivot bolt with clean grease.
2. Check the springs for damage or loss of tension.

3. **CMX1100A/A2**
Sit on the vehicle, shift the transmission to Neutral, and raise the side stand.
CMX1100D/D2/D3
Sit on the vehicle and raise the side stand.
4. **CMX1100A/A2**
Start the engine, pull the clutch lever in, and shift the transmission into gear.
CMX1100D/D2/D3
Start the engine and press the D/M side of N-D/M switch to switch the transmission into D mode.
5. Lower the side stand all the way. The engine should stop as you lower the side stand. If the engine doesn't stop, have your vehicle inspected by your dealer.

Inspecting the Drive Chain Slack

Check the drive chain slack at several points along the chain. If the slack is not constant at all points, some links may be kinked and binding.

Have the chain inspected by your dealer.

1. Shift the transmission to Neutral. Stop the engine.
2. Place your vehicle on its side stand on a firm, level surface.
3. Move the lower part of the drive chain up and down to check chain slack, midway between the sprockets.

Drive chain slack:

9/16 - 1 in (15 - 25 mm)

- ▶ Do not ride your vehicle if the slack exceeds 1 15/16 in (50 mm).

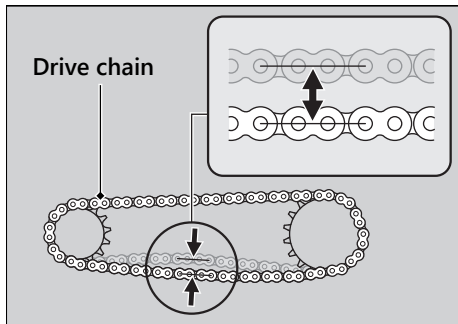

4. Roll the vehicle forward and check that the chain moves smoothly.
5. Inspect the sprockets. ➤ P. 137
6. Clean and lubricate the drive chain. ➤ P. 138

Checking the Clutch

CMX1100A/A2

Checking the Clutch Lever Freeplay

Check the clutch lever freeplay.

Freeplay at the clutch lever:

3/8 - 13/16 in (10 - 20 mm)

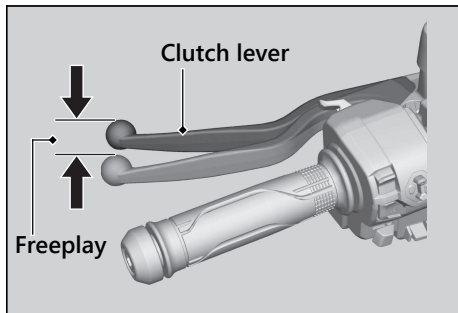

Check the clutch cable for kinks or signs of wear. If necessary, have it replaced by your dealer.

Lubricate the clutch cable with a commercially available cable lubricant to prevent premature wear and corrosion.

NOTICE

Improper freeplay adjustment can cause premature clutch wear.

Adjusting the Clutch Lever Freeplay

CMX1100A/A2

Upper Adjustment

Attempt adjustment with the upper clutch cable adjuster first.

1. Loosen the upper lock nut.
2. Turn the upper clutch cable adjuster until the freeplay is $3/8 - 13/16$ in (10 - 20 mm).
3. Tighten the upper lock nut and check the freeplay again.

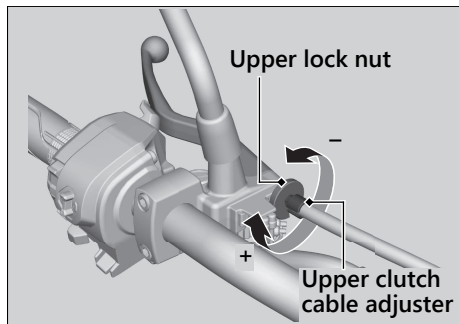

Lower Adjustment

If the upper clutch cable adjuster is threaded out near its limit, or the correct freeplay cannot be obtained, attempt adjustment with the lower clutch cable adjusting nut.

1. Loosen the upper lock nut and turn the upper clutch cable adjuster all the way in to provide maximum freeplay. Tighten the upper lock nut.
2. Loosen the lower lock nut.
3. Turn the lower adjusting nut until the clutch lever freeplay is $\frac{3}{8}$ - $\frac{13}{16}$ in (10 - 20 mm).
4. Tighten the lower lock nut and check the clutch lever freeplay.
5. Start the engine, pull the clutch lever in, and shift into gear. Make sure the engine does not stall and the vehicle does not creep. Gradually release the clutch lever and open the throttle. Your vehicle should move smoothly and accelerate gradually.

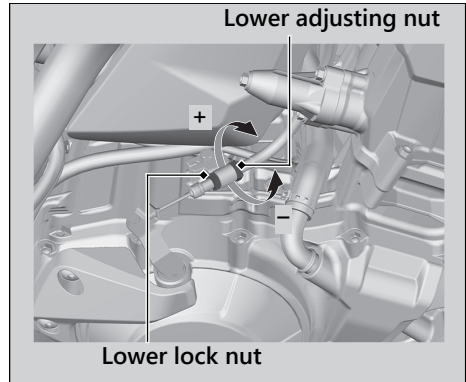

If proper adjustment cannot be obtained or the clutch does not work correctly, see your dealer.

Checking the Throttle

With the engine off, check that the throttle rotates smoothly from fully closed to fully open. If the throttle does not move smoothly or close automatically, have the vehicle inspected by your dealer.

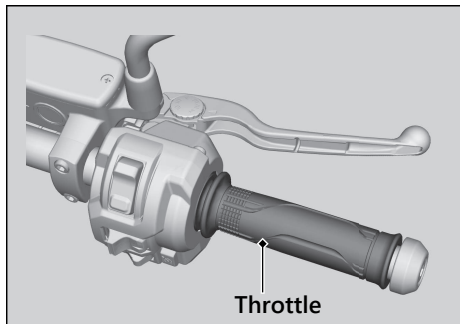

Adjusting the Brake Lever

You can adjust the distance between the brake lever and handle grip.

Adjustment method

Turn the adjuster until the numbers align with the index mark while pushing the lever forward in the desired position.

After adjustment, check that the lever operates correctly before riding.

NOTICE

Do not turn the adjuster beyond its natural limit.

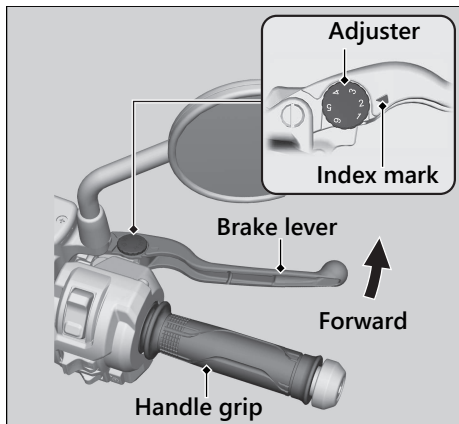

Adjusting the Front Suspension

Spring Preload

You can adjust the spring preload by the adjuster to suit the load or the road surface. Turn clockwise to increase spring preload (hard), or turn counterclockwise to decrease spring preload (soft). The standard position is $\frac{3}{8}$ in (9 mm) from the adjuster top surface to the fork bolt top surface.

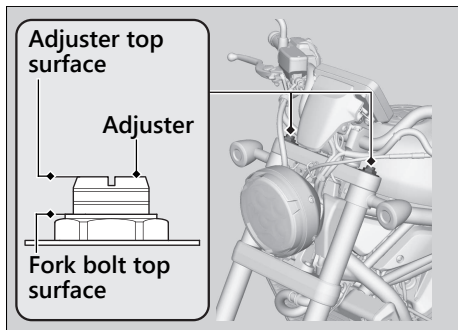

NOTICE

Do not turn the adjuster beyond its limits. Adjust both left and right forks to the same spring preload.

Adjusting the Rear Suspension

Spring Preload

You can adjust the spring preload by the adjuster to suit the load or the road surface. Turn the adjuster using the pin spanner and extension bar provided in the tool kit. ► P. 119 Turn clockwise to increase spring preload (hard), or turn counterclockwise to decrease spring preload (soft).

The standard position is 3 clicks from the minimum setting.

You can turn 3 clicks to the counterclockwise and 15 clicks clockwise from the standard position.

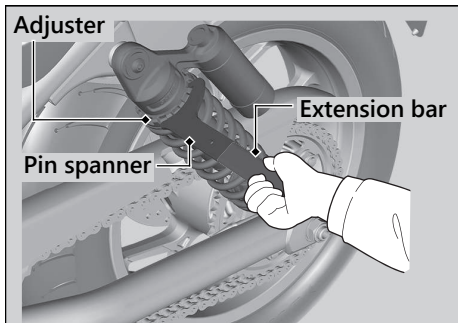

NOTICE

Do not turn the adjuster beyond its limits. Adjust both left and right shock absorbers to the same spring preload.

Troubleshooting

Engine Will Not Start	P. 167	Tire Puncture	P. 175
Overheating (High coolant temperature/ warning indicators are on)	P. 168	Smartphone Pairing Trouble	P. 176
Warning Indicators On or Flashing	P. 169	Electrical Trouble	P. 178
Low Oil Pressure Indicator	P. 169	Battery Goes Dead.....	P. 178
PGM-FI (Programmed Fuel Injection)		Burned-out Light Bulb	P. 178
Malfunction Indicator Lamp (MIL).....	P. 169	Blown Fuse	P. 179
ABS (Anti-lock Brake System) Indicator	P. 170		
Torque Control Indicator.....	P. 171		
If the “-” Indicator is Blinking in the Gear			
Position Window While Riding	P. 172		
Other Warning Indications	P. 173		
Fuel Gauge Failure Indication.....	P. 173		
Coolant Temperature Failure Indication.....	P. 174		

Starter Motor Operates But Engine Does Not Start

Check the following items:

- Check the correct engine starting sequence. ➔ P. 100
- Check that there is gasoline in the fuel tank.
- Check if the PGM-FI malfunction indicator lamp (MIL) is on.
 - ▶ If the indicator lamp is on, contact your dealer as soon as possible.

Starter Motor Does Not Operate

Check the following items:

- Check the correct engine starting sequence. ➔ P. 100
- Check for a blown fuse. ➔ P. 179
- Check for a loose battery connection (➔ P. 144) or battery terminal corrosion (➔ P. 132).
- Check the condition of the battery.
 - ➔ P. 178

If the problem continues, have your vehicle inspected by your dealer.

Overheating (High coolant temperature/warning indicators are on)

The engine is overheating when the following occurs:

- High coolant temperature indicator and warning indicator come on.

The high coolant temperature indicator is displayed in the warning information.

➔ P. 78, ➔ P. 81

- Acceleration becomes sluggish.

If this occurs, pull safely to the side of the road and perform the following procedure. Extended fast idling may cause the high coolant temperature indicator and warning indicator to come on.

NOTICE

Continuing to ride with an overheated engine can cause serious damage to the engine.

1. Stop the engine using the ignition switch, and then turn the ignition switch to the ON position.

2. Check that the radiator fan is operating, and then turn the ignition switch to the OFF position.

If the fan is not operating:

Suspect a fault. Do not start the engine. Transport your vehicle to your dealer.

If the fan is operating:

Allow the engine to cool with the ignition switch in the OFF position.

3. After the engine has cooled, inspect the radiator hose and check if there is a leak.

➔ P. 151

If there is a leak:

Do not start the engine. Transport your vehicle to your dealer.

4. Check the coolant level in the reserve tank. ➔ P. 151

▶ Add coolant as necessary.

5. If 1-4 check normal, you may continue riding, but closely monitor the high coolant temperature indicator.

Low Oil Pressure Indicator

If the low oil pressure indicator and the warning indicator come on, pull safely to the side of the road and stop the engine. The low oil pressure indicator is displayed in the warning information. 📄 P. 78, 📄 P. 81

NOTICE

Continuing to ride with low oil pressure can cause serious damage to the engine.

1. Check the engine oil level, and add oil as necessary. 📄 P. 149, 📄 P. 150
2. Start the engine.
 - ▶ Only continue riding if the low oil pressure indicator and the warning indicator go off.

Rapid acceleration may momentarily cause the low oil pressure indicator and the warning indicator to come on, especially if the oil is at or near the low level.

If the low oil pressure indicator and the warning indicator stay on when the oil level is at the proper level, stop the engine and contact your dealer.

If the engine oil level goes down rapidly, your vehicle may have a leak or another serious problem. Have your vehicle inspected by your dealer.

PGM-FI (Programmed Fuel Injection) Malfunction Indicator Lamp (MIL)

If the indicator comes on while riding, you may have a serious problem with the PGM-FI system. Reduce speed and have your vehicle inspected by your dealer as soon as possible.

ABS (Anti-lock Brake System) Indicator

If the indicator operates in one of the following ways, you may have a serious problem with the ABS. Reduce your speed and have your vehicle inspected by your dealer as soon as possible.

- Indicator comes on or starts flashing while riding.
- Indicator does not come on when the ignition switch is in the ON position.
- Indicator does not go off at speeds above 6 mph (10 km/h).

If the ABS indicator stays on, your brakes will continue to work as a conventional system, but without the anti-locking function.

The ABS indicator may flash if you turn the rear wheel while the rear wheel is lifted off the ground. In this case, turn the ignition switch to the OFF position, and then to the ON position again. The ABS indicator will go off after your speed reaches 19 mph (30 km/h).

Torque Control Indicator

If the indicator operates in one of the following ways, you may have a serious problem with the Torque Control. Reduce your speed and have your vehicle inspected by your dealer as soon as possible.

- Indicator comes and stays on (solid) while riding.
- Indicator does not come on when the ignition switch is turned to the ON position.
- Indicator does not go off at speeds above 3 mph (5 km/h).

Even when the Torque Control indicator is on, your vehicle will have normal riding ability without Torque Control function.

- When the indicator comes on while the Torque Control is in operation, you will have to completely close the throttle to regain normal riding ability.

The Torque Control indicator may come on if you rotate the rear wheel while your vehicle is lifted off the ground. In this case, turn the ignition switch to the OFF position, and then to the ON position again. The Torque Control indicator will go off after your speed reaches 3 mph (5 km/h).

If the “-” Indicator is Blinking in the Gear Position Window While Riding

CMX1100D/D2/D3

If the “-” indicator is blinking while riding, you may have a serious problem with the Dual Clutch Transmission system.

Park your vehicle in a safe place and have your vehicle inspected by a dealer immediately.

It may be possible to ride your vehicle by following the steps below.

1. Turn the ignition switch to the OFF position.
2. Turn the ignition switch to the ON position and start the engine.

If you cannot start the engine:

Turn the ignition switch to the OFF position and move the vehicle back and forth slightly (to disengage the gears).

Turn the ignition switch to the ON position again and start the engine.

If you still cannot start the engine:

Start the engine while applying the brake lever or pressing the brake pedal.

If you can shift from N to D mode:

When a gear position is shown in the gear position indicator, you can ride in that gear. Take your vehicle to your dealer riding at a safe speed.

If you can't shift from N to D mode and the “-” indicator is blinking:

Damage is preventing you from riding. Have your vehicle inspected by your dealer immediately.

Other Warning Indications

Fuel Gauge Failure Indication

If the fuel system has an error, the fuel gauge indicators will be displayed as shown in the illustration.

If this occurs, see your dealer as soon as possible.

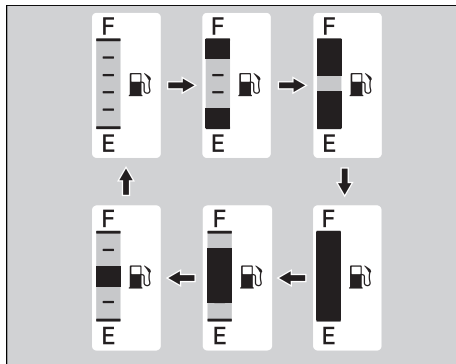
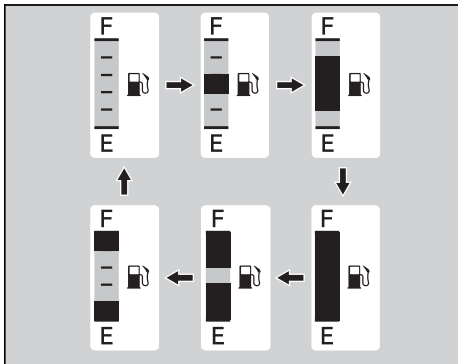

Coolant Temperature Failure Indication

If the cooling system has an error, coolant temperature “---” flashes.

If this occurs, see your dealer as soon as possible.

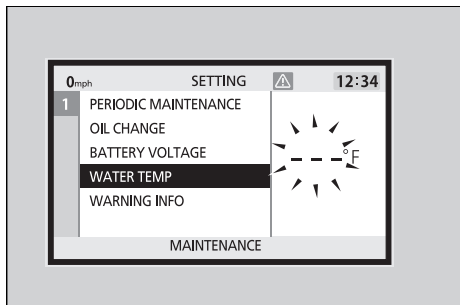

Tire Puncture

Repairing a puncture or removing a wheel requires special tools and technical expertise. We recommend you have this type of service performed by your dealer.

After an emergency repair, always have the tire inspected/replaced by your dealer.

Emergency Repair Using a Tire Repair Kit

If your tire has a minor puncture, you can make an emergency repair using a tubeless tire repair kit.

Follow the instructions provided with the emergency tire repair kit.

Riding your vehicle with a temporary tire repair is very risky. Do not exceed 30 mph (50 km/h). Have the tire replaced by your dealer as soon as possible.

WARNING

Riding your vehicle with a temporary tire repair can be risky. If the temporary repair fails, you can crash and be seriously injured or killed.

If you must ride with a temporary tire repair, ride slowly and carefully and do not exceed 30 mph (50 km/h) until the tire is replaced.

Smartphone Pairing Trouble

Symptom	Cause/remedy
Unable to pair a smartphone	Some smartphones you use may be incompatible with the vehicle and/or the operable functions may be limited.
	Check that the vehicle and smartphone are both in pairing mode. ▶ P. 92
	Check your surroundings to make sure no other device being paired is present before re-pairing. Presence of a <i>Bluetooth</i> [®] device in the vicinity sometimes affects the pairing due to radio wave interference, etc.
	When connecting a smartphone, make sure no other <i>Bluetooth</i> [®] device readied for pairing is present. Presence of a <i>Bluetooth</i> [®] device in the vicinity sometimes affects the pairing due to radio wave interference, etc.
	Check that the vehicle pairing information is deleted from your smartphone <i>Bluetooth</i> [®] setting. Depending on the smartphone used, connecting may not be possible unless the pairing information is deleted.

Symptom	Cause/remedy
Unable to connect a smartphone	Depending on the smartphone you use, it may take some time for the vehicle to connect to a smartphone and to start using a dedicated application.
	The connection may be temporarily disconnected when starting the engine, which is normal and not a malfunction. The smartphone will be reconnected after the engine is started.
	Check that <i>Bluetooth</i> [®] status icon comes on. Refer to the instruction manual of your smartphone and check that your smartphone is in connectable state.
	Some smartphones you use may not connect automatically. For connecting, follow the instructions in the instruction manual of your smartphone.
	You cannot connect two or more smartphones at once.

If the problem continues after the above-described inspection, have your vehicle inspected by your dealer.

Battery Goes Dead

Charge the battery using a motorcycle battery charger.

Remove the battery from the vehicle before charging.

Do not use an automobile-type battery charger, as these can overheat a motorcycle battery and cause permanent damage. If the battery does not recover after recharging, contact your dealer.

NOTICE

Jump starting using an automobile battery can damage your vehicle's electrical system and is not recommended.

Bump starting is also not recommended.

Burned-out Light Bulb

All light bulbs on the vehicle are LEDs. If there is an LED which is not turned on, see your dealer for servicing.

Blown Fuse

Before handling fuses, see "Inspecting and Replacing Fuses." ► P. 135

Fuse Box Fuses

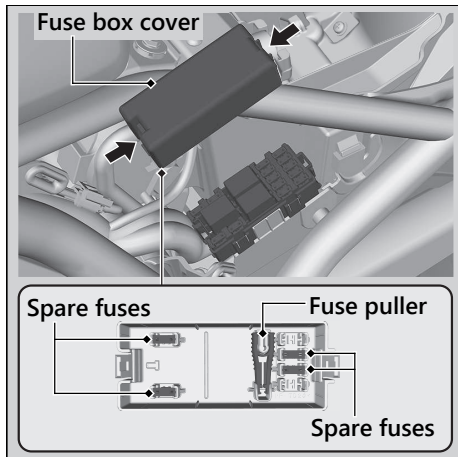

1. Remove the left side cover. ► P. 148
2. Remove the fuse box cover.
3. Pull the fuses out one by one with the fuse puller and check for a blown fuse. Always replace a blown fuse with a spare fuse of the same rating.
 - The fuse puller and the spare fuses are provided on back side of the fuse box cover.
4. Reinstall parts in the reverse order of removal.

Main Fuse & FI Fuse

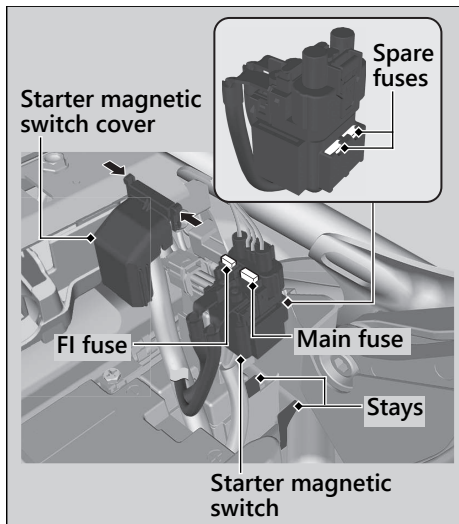

1. Remove the utility box. ► P. 144
2. Remove the starter magnetic switch cover.
3. Remove the starter magnetic switch from the stay.
4. Pull the main fuse and FI fuse out one by one with the fuse puller and check for a blown fuse. Always replace a blown fuse with a spare fuse of the same rating.
 - The spare fuses are provided in the starter magnetic switch.
 - The fuse puller is provided on the back side of the fuse box cover. ► P. 179
5. Reinstall parts in the reverse order of removal.

NOTICE

If a fuse fails repeatedly, you likely have an electrical problem. Have your vehicle inspected by your dealer.

Information

Keys.....	P. 182
Instruments, Controls, & Other Features...	P. 183
Caring for Your Vehicle.....	P. 187
Storing Your Vehicle.....	P. 190
Transporting Your Vehicle	P. 191
You & the Environment	P. 192
Vehicle Identification Number.....	P. 193
Emission Control Systems	P. 194
Catalytic Converter	P. 199
Oxygenated Fuels.....	P. 200
Authorized Manuals	P. 201
Warranty Coverage and Service	P. 202
Honda Contacts.....	P. 205
Reporting Safety Defects	P. 207

Keys

Ignition Key/Steering Lock Key

This vehicle has two ignition keys and a key tag with a key number and a bar code. Store the spare key and the key tag in a safe location. To make a duplicate key, take the spare key and the key tag to your dealer or a locksmith.

If you lose all ignition keys and the key tag, the ignition switch assembly will probably have to be removed by your dealer to determine the key number.

A metal key holder may cause damage to the area surrounding the ignition switch.

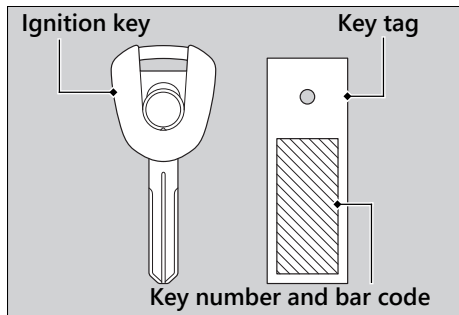

Instruments, Controls, & Other Features

Ignition Switch

Leaving the ignition switch in the ON position with the engine stopped will drain the battery.

Do not turn the key while riding.

Engine Stop Switch

Do not use the engine stop switch except in an emergency. Doing so when riding will cause the engine to suddenly turn off, making riding unsafe.

If you stop the engine using the engine stop switch, turn the ignition switch to the OFF position. Failing to do so will drain the battery.

Odometer

The display remains at 999,999 when the odometer exceeds 999,999.

Tripmeter

Each tripmeter resets to 0.0 when the trip mileage exceeds 9,999.9.

Document Bag

The owner's manual, registration, and insurance information can be stored in the plastic document bags located under the seat.

Ignition Cut-off System

A banking (lean angle) sensor automatically stops the engine and fuel pump if the vehicle falls over. To reset the sensor, you must turn the ignition switch to the OFF position and back to the ON position before the engine can be restarted.

Assist-slipper Clutch System

CMX1100A/A2

The assist-slipper clutch system helps to prevent the rear tire from locking up when the deceleration of your vehicle produces a strong engine braking effect. It also makes the clutch lever operation feel lighter.

Use only MA classification engine oil for your vehicle. Using engine oil other than MA classification oil could result in damage to the assist-slipper clutch system.

Throttle by Wire System

This model is equipped with a Throttle by Wire System.

Do not put magnetized items or items susceptible to magnetic interference near the right handlebar switches.

Automatic Brightness Control

The backlight brightness of the meter will be controlled automatically when "AUTO" is selected on the brightness setting.

Ambient brightness is detected by the photosensor.

Do not damage or cover the photosensor. Otherwise, the automatic brightness control may not work properly.

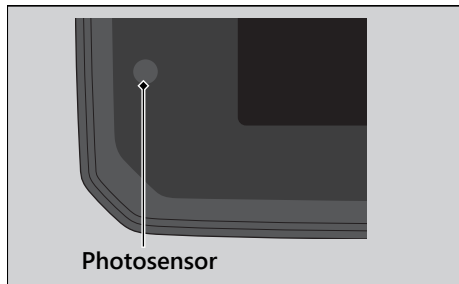

Honda RoadSync

USA

FCC ID NT8-SAB01

This device complies with Part 15 of the FCC Rules. Operation is subject to the following two conditions:

- (1) This device may not cause harmful interference, and
- (2) The device must accept any interference received, including interference that may cause undesired operation.

Changes or modifications not expressly approved by the party responsible for compliance could void the user's authority to operate the equipment.

Class B device notice

Note: This equipment has been tested and found to comply with the limits for a Class B digital device, pursuant to part 15 of the FCC Rules. These limits are designed to provide reasonable protection against harmful interference in a residential installation. This equipment generates, uses and can radiate radio frequency energy and, if not installed and used in accordance with the instructions, may cause harmful interference to radio communications. However, there is no guarantee that interference will not occur in a particular installation. If this equipment does cause harmful interference to radio or television reception, which can be determined by turning the equipment off and on, the user is encouraged to try to correct the interference by one or more of the following measures:

- Reorient or relocate the receiving antenna.
- Increase the separation between the equipment and receiver.
- Connect the equipment into an outlet on a circuit different from that to which the receiver is connected.
- Consult the dealer or an experienced radio/TV technician for help.

RF Exposure Safety

This device complies with the FCC RF exposure limits and has been evaluated in compliance with mobile exposure conditions.

The equipment must be installed and operated with minimum distance of 20 cm of the human body.

Canada

ISED CANADA IC: 3043A-SAB01

This device complies with Industry Canada License-exempt RSS standard(s). Operation is subject to the following two conditions:

- (1) This device may not cause harmful interference, and
- (2) The device must accept any interference received, including interference that may cause undesired operation.

Le présent appareil est conforme aux CNR d'Industrie Canada applicables aux appareils radio exempts de licence. L'exploitation est autorisée aux deux conditions suivantes:

- (1) l'appareil ne doit pas produire de brouillage, et,
- (2) l'utilisateur de l'appareil doit accepter tout brouillage radioélectrique subi, même si le brouillage est susceptible d'en compromettre le fonctionnement.

Changes or modifications not expressly approved by the party responsible for compliance could void the user's authority to operate the equipment.

RF Exposure Safety

This device complies with ISED RF exposure limits and has been evaluated in compliance with mobile exposure conditions.

The equipment must be installed and operated with minimum distance of 20 cm of the human body.

CAN ICES-003

This Class B digital apparatus complies with Canadian ICES-003.

Les changements ou modifications non expressément approuvés par la partie responsable de la conformité peuvent annuler le droit l'utilisateur à utiliser l'équipement Sécurité d'exposition aux RF

Cet appareil est conforme aux limites d'exposition RF d'ISDE et a été évalué conformément aux conditions d'exposition mobile.

L'équipement doit être installé et utilisé à une distance minimale de 20 cm du corps humain.

CAN NMB-003

Cet appareil numérique de classe B est conforme à la norme canadienne NMB-003.

Caring for Your Vehicle

Frequent cleaning and polishing is important to ensure the life of your Honda. A clean vehicle makes it easier to spot potential problems. In particular, seawater and salts used to prevent ice on roads promote the formation of corrosion. Also, mud and dust may accelerate front suspension wear and cause oil leaks. Always wash your vehicle thoroughly after riding on coastal, treated, muddy or dusty roads.

Washing

Allow the engine, muffler, brakes, and other high-temperature parts to cool before washing.

1. Rinse your vehicle thoroughly using a low pressure garden hose to remove loose dirt.
2. If necessary, use a sponge or a soft towel with mild cleaner to remove road grime.
 - ▶ Clean the headlight lens, panels, and other plastic components with extra care to avoid scratching them.

Avoid directing water into the air cleaner, muffler, and electrical parts.

3. Thoroughly rinse your vehicle with plenty of clean water and dry with a soft, clean cloth.
4. After the vehicle dries, lubricate any moving parts.
 - ▶ Make sure that no lubricant spills onto the brakes or tires. Brake discs, pads, drum or shoes contaminated with oil will suffer greatly reduced braking effectiveness and can lead to a crash.
5. Lubricate the drive chain immediately after washing and drying the vehicle.
6. Apply a coat of wax to prevent corrosion.
 - ▶ Avoid products that contain harsh detergents or chemical solvents. These can damage the metal, paint, and plastic on your vehicle.
Keep the wax clear of the tires and brakes.
 - ▶ If your vehicle has any matte painted parts, do not apply a coat of wax to the matte painted surface.

Washing Precautions

Follow these guidelines when washing:

- Do not use high-pressure washers:
 - ▶ High-pressure water cleaners can damage moving parts and electrical parts, rendering them inoperable.
 - ▶ Water in the air intake can be drawn into the throttle body and/or enter the air cleaner.
 - Do not direct water at the muffler:
 - ▶ Water in the muffler can prevent starting and causes rust in the muffler.
 - Dry the brakes:
 - ▶ Water adversely affects braking effectiveness. After washing, apply the brakes intermittently at low speed to help dry them.
 - Do not direct water under the seat:
 - ▶ Water in the under seat compartment can damage your documents and other belongings.
-
- Do not direct water at the air cleaner:
 - ▶ Water in the air cleaner can prevent the engine from starting.
 - Do not direct water near the headlight:
 - ▶ The headlight's inside lens may fog temporarily after washing or while riding in the rain. This does not impact the headlight function. However, if you see a large amount of water or ice accumulated inside the lens(es), have your vehicle inspected by your dealer.
 - Do not use wax or polishing compounds on matte painted surfaces:
 - ▶ Use a soft cloth or sponge, plenty of water, and a mild detergent to clean matte painted surfaces. Dry with a soft clean cloth.

Aluminum Components

Aluminum will corrode from contact with dirt, mud, or road salt. Clean aluminum parts regularly and follow these guidelines to avoid scratches:

- Do not use stiff brushes, steel wool, or cleaners containing abrasives.
- Avoid riding over or scraping against curbs.

Panels

Follow these guidelines to prevent scratches and blemishes:

- Wash gently using a soft sponge and plenty of water.
- To remove stubborn stains, use diluted detergent and rinse thoroughly with plenty of water.
- Avoid getting gasoline, brake fluid, or detergents on the instruments, panels, or headlight.

Exhaust Pipe and Muffler

If the exhaust pipe and muffler are painted, do not use a commercially available abrasive kitchen cleaning compound. Use a neutral detergent to clean the painted surface on the exhaust pipe and muffler. If you are not sure if your exhaust pipe and muffler are painted, contact your dealer.

Storing Your Vehicle

If you store your vehicle outdoors, you should consider using a full-body cover.

If you won't be riding for an extended period, follow these guidelines:

- Wash your vehicle and wax all painted surfaces (except matte painted surfaces). Coat chrome pieces with rust-inhibiting oil.
- Lubricate the drive chain. ➤ P. 137
- Place your vehicle on a maintenance stand and position a block so that both tires are off the ground.
- After rain, remove the body cover and allow the vehicle to dry.
- Remove the battery (➤ P. 144) to prevent discharge. Fully charge the battery and then place it in a shaded, well-ventilated area.
 - ▶ If you leave the battery in place, disconnect the negative ⊖ terminal to prevent discharge.

After removing your vehicle from storage, inspect all maintenance items required by the Maintenance Schedule.

USA For more information about storage, refer to the *Honda Winter Storage Guide*, available from your dealer.

Canada For more information about storage, visit our website at www.honda.ca and look up "Storage Tips" under the "Honda Warranty" in the Warranty tab for your Model.

Transporting Your Vehicle

If your vehicle needs to be transported, it should be carried on a motorcycle trailer or a flatbed truck or trailer that has a loading ramp or lifting platform and motorcycle tie-down straps. Never try to tow your vehicle with a wheel or wheels on the ground.

NOTICE

Towing your vehicle with a wheel or wheels on the ground can cause serious damage to the transmission.

You & the Environment

Owning and riding a vehicle can be enjoyable, but you must do your part to protect the environment.

Choose Sensible Cleaners

Use a biodegradable detergent when you wash your vehicle. Avoid aerosol spray cleaners that contain chlorofluorocarbons (CFCs) which damage the atmosphere's protective ozone layer.

Recycle Wastes

Put oil and other toxic wastes in approved containers and take them to a recycling center. Call your local or state office of public works or environmental services to find a recycling center in your area and to get instructions on how to dispose of non-recyclable wastes. Do not place used engine oil in the trash or pour it down a drain or on the ground. Used oil, gasoline, coolant, and cleaning solvents contain poisons that can hurt refuse workers and contaminate drinking water, lakes, rivers, and oceans.

Vehicle Identification Number

The VIN and engine serial number uniquely identify your vehicle and are required in order to register your vehicle. They may also be required when ordering replacement parts. You should record these numbers and keep them in a safe place.

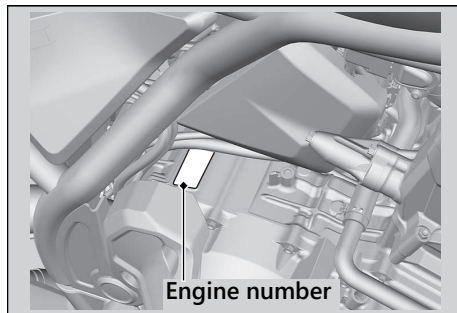
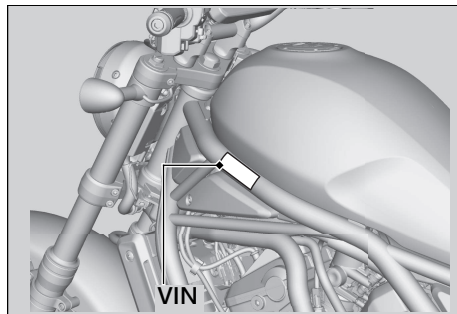
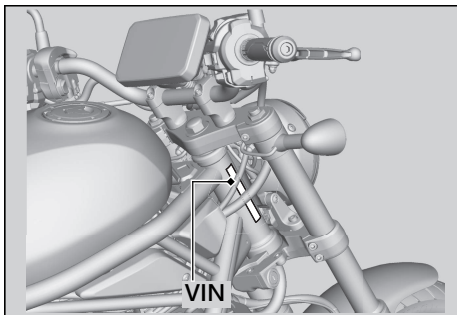

Emission Control Systems

Your vehicle engine emits combustion byproducts, including carbon monoxide (CO), oxides of nitrogen (NOx), and hydrocarbons (HC). Gasoline evaporation also emits hydrocarbons. Controlling the production of NOx, CO, and HC is important for the environment.

Exhaust Emission Requirements

The U.S. Environmental Protection Agency (EPA), the California Air Resources Board (CARB), and Environment and Climate Change Canada (ECCC) require that your vehicle comply with applicable exhaust, crankcase, and fuel permeation emission standards during its useful life, when operated and maintained according to the instructions provided.

CARB also requires that your vehicle comply with applicable evaporative emission requirements during its useful life, when

operated and maintained according to the instructions provided.

USA Compliance with the terms of the Distributor's Warranties for Honda Motorcycle Emission Control Systems is necessary in order to maintain a valid emissions system warranty.

The Vehicle Emission Control Information label is located on the left side of the swingarm.

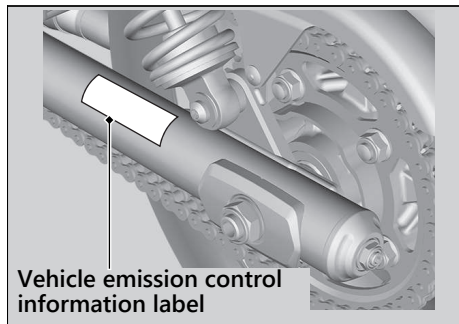

Canada only

The Vehicle Emission Control Information label is located on the right side of the swingarm.

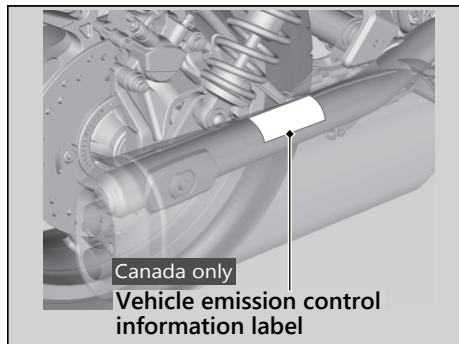

Canada only

**Vehicle emission control
information label**

Noise Emission Requirements

The EPA requires that vehicles built after January 1, 1983 comply with applicable noise emission standards for one year or 3,730 miles (6,000 km) after the time of purchase when

operated and maintained according to the instructions provided.

Exhaust Emission Control System

The exhaust emission control system includes the following components that should not need adjustment, although periodic inspection by your dealer is recommended.

PGM-FI System

The PGM-FI (programmed fuel injection) system uses sequential multiport fuel injection, and is comprised of air intake, engine control, fuel control, and exhaust control subsystems. The engine control module (ECM) uses sensors to determine how much air enters the engine, and then controls how much fuel to inject.

Ignition Timing Control System

The ignition timing control system adjusts the ignition timing to reduce the amount of HC, CO, and NOx produced.

■ Secondary Air Injection System

The secondary air injection system adds filtered air into the exhaust gas to help improve emission control performance.

■ Catalytic Converters

The exhaust system contains one or more catalytic converters. Catalytic converters use a catalyst to convert most of the harmful exhaust gas compounds into harmless compounds.

Evaporative Emission Control System

50 STATE (meets California)

An evaporative emissions control system uses a canister filled with charcoal to adsorb fuel vapor from the fuel tank while the engine is off. The vapor is drawn into the engine and burned while riding.

Crankcase Emissions Control System

The engine is equipped with a closed crankcase system to prevent discharging crankcase emissions into the atmosphere. Blow-by gas is returned to the combustion chamber through the air cleaner and throttle body.

Fuel Permeation Emission Control

The fuel tank, fuel hoses, and fuel vapor charge hoses use fuel permeation control technologies to prevent fuel vapor emissions. Tampering with these components to reduce or defeat the effectiveness of the fuel permeation technologies is prohibited.

Noise Emission Control System

TAMPERING WITH THE NOISE CONTROL SYSTEM IS PROHIBITED:

U. S. federal law prohibits, and Canadian provincial laws may prohibit, the following acts or the causing thereof: (1) The removal or rendering inoperative by any person, other than for purposes of maintenance, repair or replacement, of any device or element of design incorporated into any new vehicle for the purpose of noise control prior to its sale or delivery to the ultimate purchaser or while it is in use; or (2) the use of the vehicle after such device or element of design has been removed or rendered inoperative by any person.

AMONG THOSE ACTS PRESUMED TO CONSTITUTE TAMPERING ARE THE FOLLOWING ACTS:

- Removal of, or puncturing the muffler, baffles, header pipes or any other component which conducts exhaust gases.
- Removal of, or puncturing of any part of the intake system.
- Lack of proper maintenance.
- Removing or disabling any emissions compliance component, or replacing any compliance component with a noncompliant component.

Problems Affecting Vehicle Exhaust Emissions

Have your vehicle inspected and repaired by your dealer if you experience any of the following symptoms:

- Hard starting or stalling after starting
- Rough idling
- Misfiring or backfiring during acceleration
- Poor engine performance and poor fuel economy

Catalytic Converter

This vehicle is equipped with a three-way catalytic converter. The catalytic converter contains precious metals that serve as catalysts in high temperature chemical reactions that convert hydrocarbons (HC), carbon monoxide (CO), and oxides of nitrogen (NOx) in the exhaust gases into safe compounds.

A defective catalytic converter contributes to air pollution and can impair your engine's performance. A replacement unit must be an original Honda part or equivalent.

Follow these guidelines to protect your vehicle's catalytic converter:

- Always use unleaded gasoline. Leaded gasoline will damage the catalytic converter.
- Keep the engine in good running condition. A poorly running engine can cause the catalytic converter to overheat, causing damage to the converter or the vehicle.
- If your engine is misfiring, backfiring, stalling, or otherwise not running properly, stop riding and turn off the engine. Have your vehicle serviced as soon as possible.

Oxygenated Fuels

Some conventional fuels blended with alcohol or an ether compound are available in some locales to help reduce emissions to meet clean air standards. These gasolines are collectively referred to as oxygenated fuels. If you plan to use oxygenated fuel, check that it is unleaded and meets the minimum octane rating and blend requirement.

The following fuel blends have been approved for use in your vehicle:

- Ethanol (ethyl alcohol) up to 10% by volume.
 - ▶ Gasoline containing ethanol may be marketed under the name Gasohol.
- Do not use gasoline containing methanol (methyl alcohol).

If you accidentally fill your fuel tank with an oxygenated fuel containing higher percentages, you may experience performance problems. To resolve the problem, have your dealer drain the fuel tank and replace with the correct fuel. Fuel system or performance problems resulting from the use of an oxygenated fuel containing higher percentages are not covered by your warranty.

NOTICE

Improper use of oxygenated fuels can damage metal, rubber, and plastic parts of your fuel system.

Oxygenated fuel can also damage paint.

Damage caused by spilled fuel is not covered by warranty.

If you notice any undesirable operating symptoms or performance problems, try a different brand of gasoline.

Authorized Manuals

USA The Service Manual used by your authorized dealer is available from your Honda dealer or Helm, Inc.

Canada See your dealer to order authorized manuals.

Also available, but not necessary to service your model, is the Honda Common Service Manual, which explains basic service information for various systems on Honda motorcycles, scooters, ATV, and SxS.

USA The Winter Storage Guide in conjunction with the Owner's Manual and Service Manual can help you prepare your Honda motorcycle, scooter, ATV, and SxS for winter storage.

These Honda manuals are written for the professional technician. However, if you possess the proper tools, observe the safety standards, and are mechanically capable, you should find them easy to use.

Special Honda tools are necessary for some procedures.

USA

Order online: www.helminc.com

Order Toll Free: 1-888-CYCLE93

(1-888-292-5393)

(NOTE: For Credit Card Orders Only)

Monday - Friday 8:00 AM - 6:00 PM ET

Description
2025 Rebel 1100 Service Manual
Common Service Manual (61CSM00)
USA Winter Storage Guide (S9507)
2025 Rebel 1100 Owner's Manual

Warranty Coverage and Service

Coverage

Your new Honda is covered by the following warranties:

- Vehicle Limited Warranty
- Emission Control System Warranty
- **USA** Noise Control Warranty

The responsibilities, restrictions, and exclusions that apply to these warranties are explained in the Warranties Booklet given to you by your Honda dealer at the time of purchase. Always keep your Honda owner's card with your Warranties Booklet.

Canada Please refer to the Warranty Booklet posted on our website at www.honda.ca.

It is important to realize that your warranty applies only to defects in material or workmanship of your Honda. Your warranty coverage does not apply to the normal wear and deterioration associated with use of the vehicle.

Your warranty coverage is not voided if you perform your own maintenance. However, failures that occur due directly to improper maintenance are not covered by these warranties.

USA You can extend almost all of your warranty coverage through the HondaCare® Protection Plan. For more information, see your Honda dealer.

Statement on Warranty Coverage for Aftermarket and Recycled Parts

The Magnuson-Moss Warranty Act, 15 U.S.C. s. 2301 et seq., makes it illegal for motor vehicle manufacturers to void a motor vehicle warranty or deny warranty coverage solely because an aftermarket or recycled part has been used to repair the vehicle or someone other than the authorized service provider performed service on the vehicle. This provision does not apply to a new motor vehicle purchased solely for commercial or industrial use.

Under federal law, a manufacturer may deny warranty coverage and charge for repairs to a vehicle if it is discovered that an aftermarket or recycled part installed on the vehicle is defective or was installed incorrectly and caused damage to another part of the vehicle otherwise covered under warranty. The Federal Trade Commission requires that a manufacturer demonstrate that an aftermarket or recycled part or service performed by a person other than an

authorized service provider caused damage to another part of the vehicle otherwise covered under warranty before denying warranty coverage. Additionally, federal law allows a manufacturer to void a motor vehicle warranty or deny warranty coverage if the manufacturer provides the article or service to consumers free of charge under the warranty or the manufacturer has secured a waiver from the Federal Trade Commission.

Warranty Coverage and Service

Service

Please remember that maintenance recommended in the Maintenance Schedule is not included in your warranty coverage.

If you believe you have a problem with your vehicle, call the service department of your Honda dealer. Make an appointment for an inspection and diagnosis. You will be asked to authorize that inspection, and your dealer will return the results of the inspection. If a problem exists and is covered under warranty, your dealer will perform the warranty repairs. If you have any questions about your warranty coverage or the nature of the repair, talk to the Service Manager of your Honda dealer.

If a misunderstanding occurs and you aren't satisfied with your dealer's handling of the situation, we suggest you discuss your problem with the appropriate member of the dealership's management team. If you are still not satisfied, contact the owner of the dealership or their designated representative.

Honda Contacts

American Honda Motor Co., Inc.

If you wish to contact Honda directly to comment on your experiences with your vehicle or with your dealer, please send your comments using one of the following methods:



POST MAIL

Powersports Customer Relations
American Honda Motor Co., Inc.
4900 Marconi Drive
Alpharetta, GA 30005-8847



PHONE

Telephone: (866) 784-1870



ONLINE CUSTOMER SERVICE

Website: <https://powersports.honda.com/contact-us>

Canada

Honda Canada Inc.
Customer Relations Department,
180 Honda Boulevard
Markham, Ontario
L6C 0H9
Telephone: (888) 946-6329
Fax: (877) 939-0909
E-mail: honda_cr@ch.honda.com

Please include the following information in your letter:

- Name, address, and telephone number
- Product model, year, and VIN
- Date of purchase
- Dealer name and address

We will likely ask your Honda dealer to respond, or possibly acknowledge your comments directly.

Your Honda Dealer

The service department of your Honda dealer offers trained personnel to perform regular maintenance and unexpected repairs. It has the latest available service information from Honda and also handles warranty inspections and repairs.

The parts department offers Honda Genuine Parts, Pro Honda products, Honda Accessories (USA only), and Honda accessories and products (Canada only) that provide the same quality that went into your vehicle.

USA The sales department offers the HondaCare[®] Protection Plan to extend almost all of your warranty coverage.

Your Honda dealer can also supply information about riding events and information about safety training available in your local area.

Reporting Safety Defects

USA

If you believe that your vehicle has a defect which could cause a crash or could cause injury or death, you should immediately inform the National Highway Traffic Safety Administration (NHTSA) in addition to notifying American Honda Motor Co., Inc.

If NHTSA receives similar complaints, it may open an investigation, and if it finds that a safety defect exists in a group of vehicles, it may order a recall and remedy campaign. However, NHTSA cannot become involved in individual problems between you, your dealer, or American Honda Motor Co., Inc.

To contact NHTSA, you may call the Vehicle Safety Hotline toll-free at:

1-888-327-4236

(TTY: 1-800-424-9153); go to

<https://www.safercar.gov>;

or write to:

Administrator, NHTSA,

1200 New Jersey Avenue, SE.,

Washington, DC 20590.

You can also obtain other information about motor vehicle safety from:

<https://www.safercar.gov>.

Reporting Safety Defects

Canada

If you believe that your vehicle has a defect which could cause a crash or could cause injury or death, you should immediately inform Honda Canada Inc. and you may also inform Transport Canada.

If Transport Canada receives similar complaints, it may open an investigation, and if it finds that a safety defect exists in a group of vehicles, it may lead to a recall and remedy campaign. However, Transport Canada cannot become involved in individual problems between you, your dealer, or Honda Canada Inc.

To contact Transport Canada's Defect Investigations and Recalls Division,

Mailing Address:
Transport Canada - ASFAD
330 Sparks Street
Ottawa, ON
K1A 0N5

Telephone: 819-994-3328 (Ottawa-Gatineau area or internationally)
Toll free: 1-800-333-0510 (in Canada)

Online:
(English Link:) www.tc.canada.ca/recalls
(French Link:) www.tc.canada.ca/rappels

For more information on reporting safety defects or about motor vehicle safety, go to
<https://www.tc.gc.ca/roadsafety>.

Specifications

■ Main Components

Overall length	88.2 in (2,240 mm)	
Overall width	CMX1100A/A2	33.5 in (850 mm)
	CMX1100D	32.9 in (835 mm)
	CMX1100D2	33.3 in (845 mm)
Overall height	CMX1100D3	34.6 in (880 mm)
	CMX1100A/D/D3	44.3 in (1,125 mm)
	CMX1100A2/D2	46.5 in (1,180 mm)
Wheelbase	59.8 in (1,520 mm)	
Minimum ground clearance	4.7 in (120 mm)	
Caster angle	28° 0'	
Trail	4.3 in (110 mm)	

	CMX1100A	
	50 STATE (meets California)	494 lb (224 kg)
	Canada model	498 lb (226 kg)
	CMX1100D	
	50 STATE (meets California)	516 lb (234 kg)
	Canada model	520 lb (236 kg)
Curb weight	CMX1100A2	
	50 STATE (meets California)	525 lb (238 kg)
	Canada model	529 lb (240 kg)
	CMX1100D2	
	50 STATE (meets California)	547 lb (248 kg)
	Canada model	551 lb (250 kg)
	CMX1100D3	
	50 STATE (meets California)	518 lb (235 kg)
Maximum weight capacity *1	CMX1100A/D/D3	348 lb (158 kg)
	CMX1100A2/D2	328 lb (149 kg)

*1 : Including rider, passenger, all luggage, and accessories

Specifications

Maximum luggage weight	CMX1100A2/D2		
	Saddle bag	Right	11.0 lb (5.0 kg)
Passenger capacity		Left	11.0 lb (5.0 kg)
	USA model (Model not equipped with Optional Passenger Seat Kit)	Rider only (no passenger)	
	Canada model and USA model equipped with Optional Passenger Seat Kit	Rider and 1 passenger	
	Minimum turning radius	9.5 ft (2.90 m)	

Displacement	66.1 cu-in (1,084 cm ³)	
Bore x stroke	3.62 x 3.21 in (92.0 x 81.5 mm)	
Compression ratio	10.5 : 1	
Fuel	Unleaded gasoline Recommended: 86 PON or higher	
Tank capacity	3.59 US gal (13.6 L)	
Battery	YTZ14S	
	12 V-11.2 Ah (10 HR)	
Gear ratio	CMX1100A/A2	
	1st	2.866
	2nd	1.888
	3rd	1.480
	4th	1.230
	5th	1.064
	6th	0.972
	CMX1100D/D2/D3	
	1st	2.562
	2nd	1.761
	3rd	1.375
	4th	1.133
5th	0.972	
6th	0.882	
Reduction ratio (primary / final)	CMX1100A/A2	1.717 / 2.625
	CMX1100D/D2/D3	1.863 / 2.625

■ Service Data

Tire size	Front	130/70B18M/C 63H
	Rear	180/65B16M/C 81H
Tire type		Bias-ply, tubeless
Recommended tire	Front	DUNLOP D428F
	Rear	DUNLOP D428
Tire air pressure	Front	33 psi (225 kPa, 2.25 kgf/cm ²)
	Rear	33 psi (225 kPa, 2.25 kgf/cm ²)
Minimum tread depth	Front	0.06 in (1.5 mm)
	Rear	0.08 in (2.0 mm)
Spark plug		SILMAR8A9S (NGK)
Spark plug gap		0.031 - 0.035 in (0.80 - 0.90 mm)
Idle speed	(non-adjustable)	1,250 ± 100 rpm
Recommended engine oil		API Service Classification SJ or higher except oils labeled as energy conserving or resource conserving on the circular API service label, SAE 10W-30, JASO T 903 standard MA, Pro Honda GN4 4-stroke oil (USA & Canada) or Honda 4-stroke oil, or an equivalent motorcycle oil

Engine oil capacity	CMX1100A/A2	
	After draining	4.1 US qt (3.9 L)
	After draining & engine oil filter change	4.2 US qt (4.0 L)
	After disassembly	5.1 US qt (4.8 L)
	CMX1100D/D2/D3	
	After draining	4.2 US qt (4.0 L)
Recommended brake fluid	After draining & engine oil filter change	4.4 US qt (4.2 L)
	After draining, engine & clutch oil filter change	4.4 US qt (4.2 L)
	After disassembly	5.5 US qt (5.2 L)
	Recommended engine oil	Honda DOT 4 Brake Fluid
Cooling system capacity	1.84 US qt (1.74 L)	
Recommended coolant	Pro Honda HP Coolant	

Specifications

Recommended drive chain lubricant	Pro Honda HP Chain Lube or equivalent	
Drive chain slack	9/16 - 1 in (15 - 25 mm)	
Standard drive chain	RK BP525MRO	
	No. of links	114
Standard sprocket size	Drive sprocket	16T
	Driven sprocket	42T

■ Bulbs

Headlight	LED
Brake light/Taillight	LED
Front turn signal/Position light	LED
Rear turn signal	LED
License plate light	LED

■ Fuses

Main fuse	30 A
Other fuse	30 A, 20 A, 15 A, 10 A, 7.5 A

Information Record

VIN	
Engine No.	
Color Label & Code	
Owner's Name	
Address	
City/State	
Phone	
Dealer's Name	
Address	
City/State	
Phone	
Service Manager	

California Proposition 65 Warning

 **WARNING:** Operating, servicing and maintaining a passenger vehicle or off-highway motor vehicle can expose you to chemicals including engine exhaust, carbon monoxide, phthalates, and lead, which are known to the State of California to cause cancer and birth defects or other reproductive harm. To minimize exposure, avoid breathing exhaust, do not idle the engine except as necessary, service your vehicle in a well-ventilated area and wear gloves or wash your hands frequently when servicing your vehicle. For more information go to www.P65Warnings.ca.gov/passenger-vehicle.



31MLA640
00X31-MLA-6400

© 2024 Honda Motor Co., Ltd.
All Rights Reserved

Printed in Japan