

OWNER'S MANUAL

2024 CBR600RR

This manual should be considered a permanent part of the vehicle and should remain with the vehicle when it is resold.

This publication includes the latest production information available before printing. Honda Motor Co., Ltd. reserves the right to make changes at any time without notice and without incurring any obligation.

No part of this publication may be reproduced without written permission.

The vehicle pictured in this owner's manual may not match your actual vehicle.

Welcome

Congratulations on your purchase of a new Honda vehicle. Your selection of a Honda makes you part of a worldwide family of satisfied customers who appreciate Honda's reputation for building quality into every product.

To ensure your safety and riding pleasure:

- Read this owner's manual carefully.
- Follow all recommendations and procedures contained in this manual.
- Pay close attention to safety messages contained in this manual and on the vehicle.

To protect your investment, we urge you to take responsibility for keeping your vehicle well-serviced and maintained. Also, observe the break-in guidelines and always perform the pre-ride inspection and other periodic checks in this manual.

When service is required, remember that your Honda dealer knows your vehicle best. If you have the required mechanical "know-how" and tools, you can purchase an official Honda Service Manual to help you perform many maintenance and repair tasks. ➔ P. 107

Read the warranty information thoroughly so that you understand the warranty coverage and are aware of your rights and responsibilities. ➔ P. 108

You may also want to visit our website at www.powersports.honda.com.
Happy riding!

A Few Words About Safety

Your safety, and the safety of others, is very important. Operating this vehicle safely is an important responsibility.

To help you make informed decisions about safety, we have provided operating procedures and other information on safety labels and in this manual. This information alerts you to potential hazards that could hurt you or others.

Of course, it is not practical or possible to warn you about all hazards associated with operating or maintaining a vehicle. You must use your own good judgment.

You will find important safety information in a variety of forms, including:

- Safety labels on the vehicle
- Safety Messages preceded by a safety alert symbol  and one of three signal words: DANGER, WARNING, or CAUTION.

These signal words mean:

DANGER

You **WILL** be **KILLED** or **SERIOUSLY HURT** if you don't follow instructions.

WARNING

You **CAN** be **KILLED** or **SERIOUSLY HURT** if you don't follow instructions.

CAUTION

You **CAN** be **HURT** if you don't follow instructions.

Other important information is provided under the following titles:

NOTICE Information to help you avoid damage to your vehicle, other property, or the environment.

Contents

Vehicle Safety P. 2

Operation Guide P. 16

Maintenance P. 32

Troubleshooting P. 78

Information P. 90

Specifications P. 114

Vehicle Safety

This section contains important information for safe riding of your vehicle.
Please read this section carefully.

Safety Guidelines	P. 3
Safety Labels	P. 7
Safety Precautions	P. 9
Riding Precautions	P. 10
Accessories & Modifications	P. 14
Loading	P. 15

Safety Guidelines

Follow these guidelines to enhance your safety:

- Perform all routine and regular inspections specified in this manual.
- Stop the engine and keep sparks and flames away before filling the fuel tank.
- Do not run the engine in enclosed or partly enclosed areas. Carbon monoxide in exhaust gases is toxic and can kill you.

Always Wear a Helmet

It's a proven fact: helmets and protective apparel significantly reduce the number and severity of head and other injuries. So always wear an approved helmet and protective apparel. 📄 P. 9

Before Riding

Make sure that you are physically fit, mentally focused, and free of alcohol and drugs. Check that you and your passenger are both wearing an approved helmet and protective apparel. Instruct your passenger on holding onto the seat strap or your waist, leaning with you in turns, and keeping their feet on the footpegs, even when the vehicle is stopped.

Take Time to Learn & Practice

Even if you have ridden other vehicles, practice riding in a safe area to become familiar with how this vehicle works and handles, and to become accustomed to the vehicle's size and weight.

Safety Guidelines

We recommend that all riders take a certified course approved by the Motorcycle Safety Foundation (MSF) or a state approved training course. New riders should start with the basic course, and even experienced riders will find the advanced course beneficial.

For information about the MSF training course nearest you, call the national toll-free number: (800) 446-9227.

Other riding tips can be found in the You and Your Motorcycle Riding Tips booklet that came with your vehicle.

Ride Defensively

Always pay attention to other vehicles around you, and do not assume that other drivers see you. Be prepared to stop quickly or perform an evasive maneuver.

Make Yourself Easy to See

Make yourself more visible, especially at night, by wearing bright reflective clothing, positioning yourself so other drivers can see you, signaling before turning or changing lanes, and using your horn when necessary.

Ride within Your Limits

Never ride beyond your personal abilities or faster than conditions warrant. Fatigue and inattention can impair your ability to use good judgment and ride safely.

Don't Drink or Use Drugs and Ride

Alcohol or drugs and riding don't mix. Even one alcoholic drink can reduce your ability to respond to changing conditions, and your reaction time gets worse with every additional drink. The same is true for drug use. Don't drink or use and ride, and don't let your friends do it either.

Keep Your Honda in Safe Condition

It's important to keep your vehicle properly maintained and in safe riding condition. Inspect your vehicle before every ride and perform all recommended maintenance. Never exceed load limits (➤ P. 15), and do not modify your vehicle or install accessories that would make your vehicle unsafe (➤ P. 14).

If You are Involved in a Crash

Personal safety is your first priority. If you or anyone else has been injured, take time to assess the severity of the injuries and whether it is safe to continue riding. Call for emergency assistance if needed. Also follow applicable laws and regulations if another person or vehicle is involved in the crash.

If you decide to continue riding, first turn the ignition switch to the OFF position, and evaluate the condition of your vehicle. Inspect for fluid leaks, check the tightness of critical nuts and bolts, and check the handlebars, control levers, brakes, and wheels. Ride slowly and cautiously. Your vehicle may have suffered damage that is not immediately apparent. Have your vehicle thoroughly checked at a qualified service facility as soon as possible.

Carbon Monoxide Hazard

Exhaust contains poisonous carbon monoxide, a colorless, odorless gas. Breathing carbon monoxide can cause loss of consciousness and may lead to death.

If you run the engine in a confined or even partly enclosed area, the air you breathe could contain a dangerous amount of carbon monoxide.

Never run your vehicle inside a garage or other enclosure.

WARNING

Running the engine of your vehicle while in an enclosed or even partially enclosed area can cause a rapid build-up of toxic carbon monoxide gas.

Breathing this colorless, odorless gas can quickly cause unconsciousness and lead to death.

Only run your vehicle's engine when it is located in a well ventilated area outdoors.

Safety Labels

Safety and information labels on your vehicle provide important safety information and may warn you of potential hazards that could cause

serious injury. Read these labels carefully and don't remove them.

If a label comes off or becomes hard to read, contact your dealer for a replacement.

For your protection, always wear your helmet while riding.
Read the owner's manual carefully.

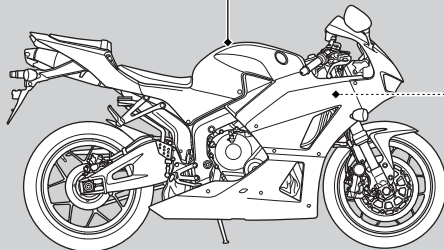

Safety Labels

TIRE INFORMATION				
Cold tire pressures		kPa	kg/cm ²	psi
Up to maximum weight capacity	Front	250	2.50	36
	Rear	290	2.90	42
Up to 90kg(200lbs) load	Front	250	2.50	36
	Rear	290	2.90	42
Tire size	Front	120/70ZR17M/C(58W)		
	Rear	180/55ZR17M/C(73W)		
Minimum recommend tire center tread depth.	Front	1.5mm (0.06in.)		
	Rear	2.0mm (0.08in.)		
Maximum weight capacity	166kg(366lbs)			

DRIVE CHAIN
Keep chain adjusted and lubricated. 35 mm (1 3/8 in.) Freeplay
 Freeplay
Read owner's manual.

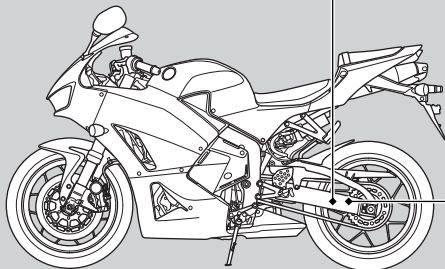

WARNING

Improper loading can cause a crash and you may be seriously hurt or killed. See "Load Limits and Guidelines" in your Owner's Manual for complete instructions.

Safety Precautions

- Ride cautiously and keep your hands on the handlebars and feet on the footpegs.
- Instruct your passenger to keep their hands on the seat strap or your waist and their feet on the footpegs while riding.
- Always consider the safety of your passenger, as well as other drivers and riders.

Protective Apparel

Make sure that you and any passenger are wearing an approved helmet, eye protection, and high-visibility protective clothing. Avoid wearing loose clothes that could get caught on any part of the vehicle. Ride defensively in response to weather and road conditions.

■ Helmet

Should be safety-standard certified, high-visibility, and the correct size for your head.

- Must fit comfortably but securely, with the chin strap fastened

- Face shield with unobstructed field of vision or other approved eye protection

Look for a DOT (Department of Transportation) certification label on any helmet you buy.

⚠ WARNING

Not wearing a helmet increases the chance of serious injury or death in a crash.

Make sure that you and any passenger always wear an approved helmet and protective apparel.

Riding Precautions

| Gloves

Full-finger leather gloves with high abrasion resistance

| Boots or Riding Shoes

Sturdy boots with non-slip soles and ankle protection

| Jacket and Pants

Protective, highly visible, long-sleeved jacket and durable long pants for riding (or a protective suit)

Riding Precautions

Break-in Period

During the first 300 miles (500 km) of running, follow these guidelines to ensure your vehicle's future reliability and performance.

- Avoid full-throttle starts and rapid acceleration.
- Avoid hard braking and rapid down-shifts.
- Ride conservatively.

Brakes

Observe the following guidelines:

- Avoid excessively hard braking and downshifting.
 - ▶ Sudden braking can reduce the vehicle's stability.
 - ▶ Where possible, reduce speed before turning; otherwise you risk sliding out.

- Exercise caution on low traction surfaces.
 - ▶ The tires slip more easily on such surfaces and braking distances are longer.
- Avoid continuous braking.
 - ▶ Repeated braking, such as when descending long, steep slopes can seriously overheat the brakes, reducing their effectiveness. Use engine braking with intermittent use of the brakes to reduce speed.
- For full braking effectiveness, operate both the front and rear brakes together.

Combined ABS

CBR600RA

Even when the brake lever and brake pedal are applied separately, the combined ABS distributes braking pressure between the front and rear wheels according to braking force and wheel speed to enhance your stopping power and stability. The system also controls braking pressure to prevent wheel lockup. To get the best results, operate the lever and pedal together and perform most of your braking in a straight line to avoid sliding out in a turn.

- Combined ABS cannot make up for road conditions, bad judgment, or improper operation of the brakes, and cannot stop rear wheel lift completely.
 - ▶ Never ride faster than conditions permit and always leave enough space to safely brake to a stop.

Riding Precautions

- When Combined ABS does not function, the brakes work like a conventional braking system. On conventional braking systems, operating the front brake lever applies the front brake and operating the rear brake pedal applies the rear brake.
 - ▶ The system is always turned off at speeds less than 4 mph (6 km/h).
- It is important to follow the tire recommendations (➤ P. 115), because the Combined ABS computer works by comparing wheel speed. Incorrect tires can affect wheel speed and confuse the system.
- Combined ABS may not always reduce stopping distance over a vehicle equipped with conventional brakes.
- Combined ABS does not operate when the battery level is discharged.
- Combined ABS does not operate when the ABS main or ABS motor fuses are burned out.

You may feel a change in the way the brake lever/pedal reacts when it is operated under the following conditions:

- Immediately after turning the ignition switch to the ON position.
- After braking to a stop and applying the brakes again.

■ Engine Braking

Engine braking helps slow your vehicle down when you release the throttle. For further slowing action, downshift to a lower gear. Use engine braking with intermittent use of the brakes to reduce speed when descending long, steep slopes.

■ Wet or Rainy Conditions

Road surfaces are slippery when wet, and wet brakes further reduce braking efficiency. Exercise extra caution when braking in wet conditions.

If the brakes get wet, apply the brakes while riding at low speed to help them dry.

Parking

- Park on a firm, level surface.
- If you must park on a slight incline or loose surface, park so that the vehicle cannot move or fall over.
- Make sure that high-temperature parts cannot come into contact with flammable materials.
- Do not touch the engine, muffler, brakes and other high-temperature parts until they cool down.
- To reduce the likelihood of theft, always lock the handlebars and remove the key when leaving the vehicle unattended. Use of an anti-theft device is also recommended.

■ Parking with the Side Stand

1. Stop the engine.
2. Push the side stand down.
3. Slowly lean the vehicle to the left until its weight rests on the side stand.

4. Turn the handlebars fully to the left.
 - ▶ Turning the handlebars to the right reduces stability and may cause the vehicle to fall.
5. Turn the ignition switch to the LOCK position and remove the key. ➤ P. 26

Refueling and Fuel Guidelines

Follow these guidelines to protect the engine, fuel system and catalytic converter:

- Use only unleaded gasoline.
- Use the recommended octane number. Using lower octane gasoline will result in decreased engine performance.
- Do not use fuels containing a high concentration of alcohol. ➤ P. 106
- Do not use stale or contaminated gasoline or an oil/gasoline mixture.
- Avoid getting dirt or water in the fuel tank.

Accessories & Modifications

We strongly advise that you do not add any accessories that were not specifically designed or approved for your vehicle by Honda or make modifications to your vehicle from its original design. Doing so can make it unsafe. Modifying your vehicle may also void your warranty and make your vehicle illegal to operate on public roads. Before deciding to install accessories on your vehicle, be certain the modification is safe and legal.

WARNING

Improper accessories or modifications can cause a crash in which you can be seriously hurt or killed.

Follow all instructions in this owner's manual regarding accessories and modifications.

Do not pull a trailer with, or attach a sidecar to, your vehicle. Your vehicle was not designed for these attachments, and their use can seriously impair your vehicle's handling.

Loading

- Carrying extra weight affects your vehicle's handling, braking and stability. Always ride at a safe speed for the load you are carrying.
- Avoid carrying an excessive load and keep within specified load limits.
Maximum weight capacity ➤ P. 114
- Tie all luggage securely, evenly balanced, and close to the center of the vehicle.
- Do not place objects near the lights or the muffler.

WARNING

Overloading or improper loading can cause a crash and you can be seriously hurt or killed.

Follow all load limits and other loading guidelines in this manual.

Parts Location

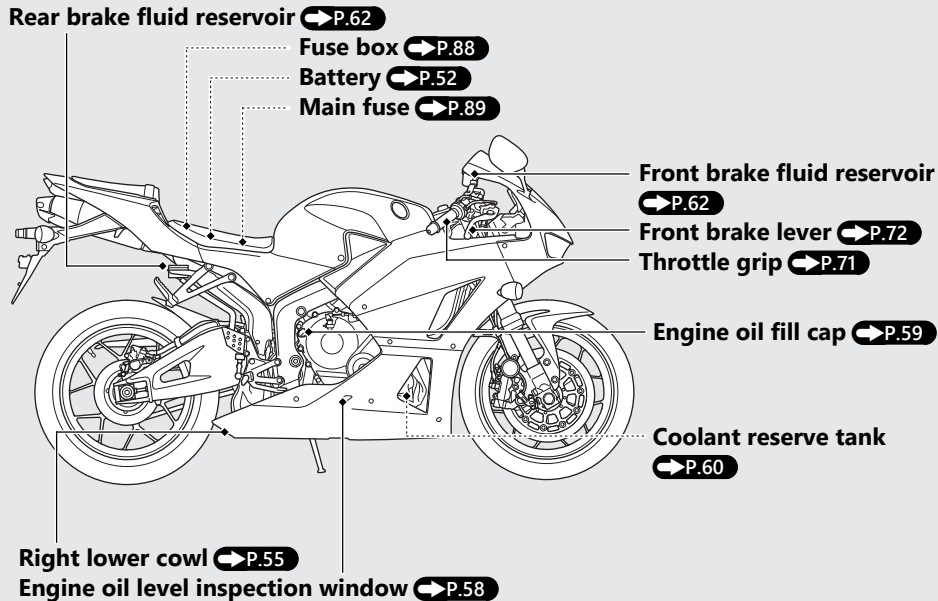

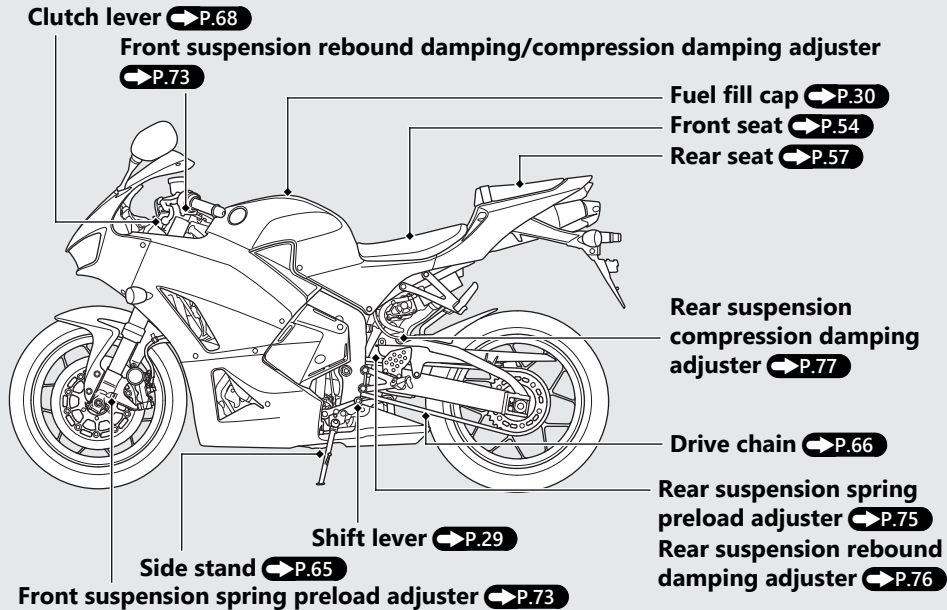

Instruments

SEL button

RESET button

Tachometer

NOTICE

Do not operate the engine in the tachometer red zone. Excessive engine speed can adversely affect engine life.

Tachometer red zone

(excessive engine rpm range)

RESET button

- Press **RESET** button to change the speed and mileage units ("mph" & "mile" / "km/h" & "km") for the speedometer, odometer, and tripmeter with the display in the tripmeter A.
- Press **RESET** button to change the coolant temperature unit ("°F" / "°C") for the coolant temperature gauge with the display in the tripmeter B.

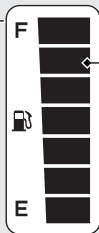

Fuel gauge

Remaining fuel when only 1st (E) segment starts flashing: approximately 1.00 US gal (3.8 L)

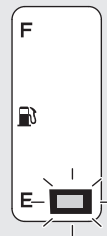

If the fuel gauge indicator flashes in a repeat pattern or turns off: ➔ P.83

NOTICE

You should refuel when the reading approaches the E (1st) segment. Running out of fuel can cause the engine to misfire, damaging the catalytic converter.

Display Check

When the ignition switch is turned to the ON position, all the mode and digital segments will show.

If any part of these displays does not come on when it should, have your dealer check for problems.

Instruments (Continued)

SEL button

RESET button

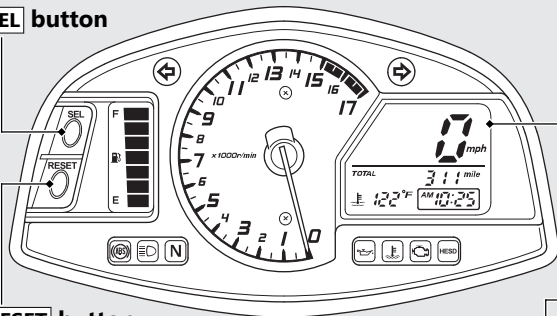

Speedometer

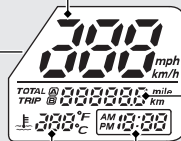

**Clock
(12-hour display)**

Coolant temperature gauge ()

Display range: 95 °F (35 °C) to 270 °F (132 °C)

- Below 94 °F (34 °C): "—" displays
- Between 251 °F (122 °C) and 269 °F (131 °C):
 - High coolant temperature indicator lights
 - Coolant temperature gauge (flashing digits)
- Above 270 °F (132 °C):
 - High coolant temperature indicator lights
 - "270" (°F) / "132" (°C) flashes

- ▶ Even if the engine coolant temperature is low, the cooling fan may start running when you rev up the engine. This is normal.

Odometer [TOTAL] & Tripmeter [TRIP A/B]

SEL button switches between the odometer and tripmeters.

- Odometer: Total distance ridden.
- Tripmeter: Distance ridden since tripmeter was reset (press and hold **RESET** button to reset to 0.0 mile/km).

To set the clock:

- 1 Turn the ignition switch to the ON position.
- 2 Press and hold **SEL** and **RESET** buttons until the hour digits start flashing.



- 3 Press **RESET** button until the desired hour is displayed.
 - ▶ Press and hold **RESET** button to advance the hour fast.



- 4 Press **SEL** button. The minute digits start flashing.

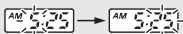

- 5 Press **RESET** button until the desired minute is displayed.
 - ▶ Press and hold **RESET** button to advance the minute fast.

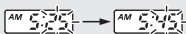

- 6 Press **SEL** button. The clock is set.
 - ▶ The time can also be set by turning the ignition switch to the OFF position.

The display will stop flashing automatically and the adjustment will be cancelled if the button is not pressed for about 30 seconds.

Indicators

If one of these indicators does not come on when it should, have your dealer check for problems.

CBR600RA

Combined ABS indicator

Comes on when the ignition switch is turned to the ON position.

Goes off when your speed reaches approximately 6 mph (10 km/h).

If it comes on while riding:  **P.82**

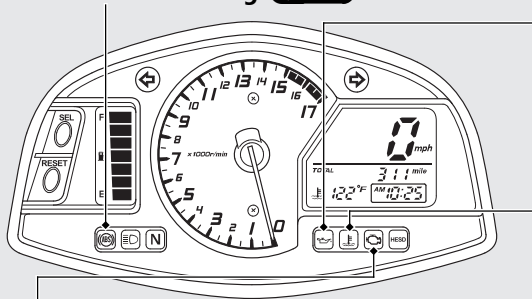

Low oil pressure indicator

Comes on when the ignition switch is turned to the ON position. Goes off when the engine starts.



If it comes on while engine is running:  **P.81**

High coolant temperature indicator

If it comes on while riding:

 **P.80**

PGM-FI (Programmed Fuel Injection) malfunction indicator lamp (MIL)

Comes on briefly when the ignition switch is turned to the ON position with the engine stop switch in the  (Run) position. **If it comes on while engine is running:**  **P.81**

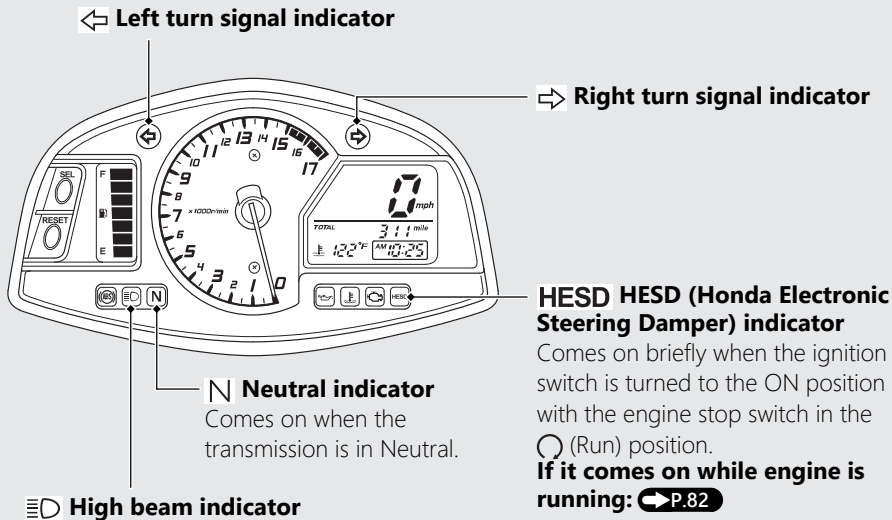

HESD (Honda Electronic Steering Damper) indicator

Comes on briefly when the ignition switch is turned to the ON position with the engine stop switch in the (Run) position.

If it comes on while engine is running: → P.82

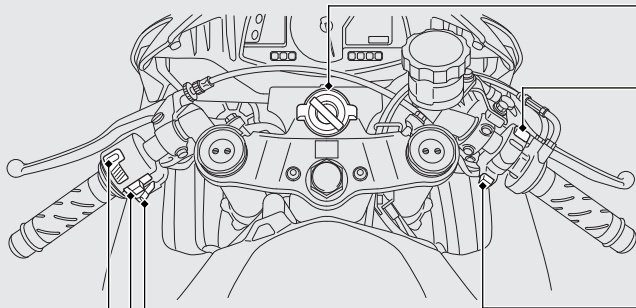

Switches



 **Horn button**

 **Turn signal switch**

Headlight dimmer switch

-  : High beam
-  : Low beam

Engine stop switch

Should normally remain in the  (Run) position.

- ▶ In an emergency, switch to the  (Stop) position to stop the engine.

 **Start button**

Headlight turns off when operating the starter motor.

Ignition Switch

Switches the electrical system on/off, locks the steering.

- ▶ Key can be removed when in the OFF or LOCK position.

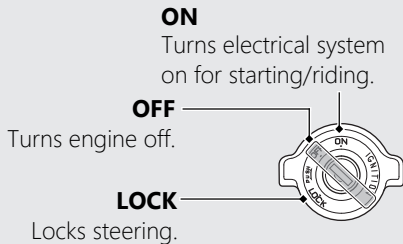

Switches *(Continued)*

Steering Lock

Lock the steering when parking to help prevent theft.

A U-shaped wheel lock or similar device is also recommended.

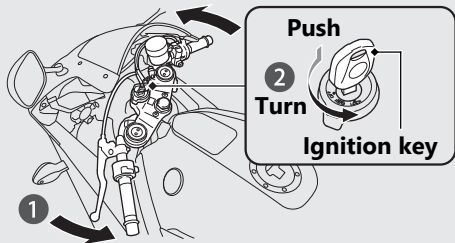

Locking

- 1 Turn the handlebars all the way to the left.
- 2 Push the key down, and turn the ignition switch to the LOCK position.
 - ▶ Jiggle the handlebars if the lock is difficult to engage.
- 3 Remove the key.



Unlocking

Insert the key, push it in, and turn the ignition switch to the OFF position.

Starting the Engine

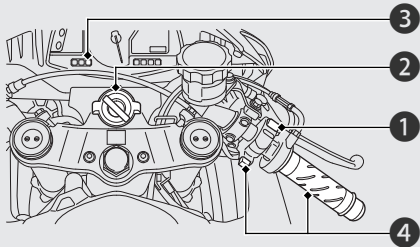
Start your engine using the following procedure, regardless of whether the engine is cold or warm.



- 1 Make sure the engine stop switch is in the  (Run) position.
- 2 Turn the ignition switch to the ON position.
- 3 Shift the transmission to Neutral ( indicator comes on). Alternatively, pull in the clutch lever to start your vehicle with the transmission in gear so long as the side stand is raised.
- 4 Press the start button with the throttle completely closed.

NOTICE

- If the engine does not start within 5 seconds, turn the ignition switch to the OFF position and wait 10 seconds before trying to start the engine again to recover battery voltage.
- Extended fast idling and revving the engine can damage the engine and the exhaust system.
- Snapping the throttle or fast idling for more than about 5 minutes may cause exhaust pipe discoloration.
- The engine will not start if the throttle is fully open.

Starting the Engine *(Continued)*

If you cannot start the engine:

Hold the throttle slightly open (about 1/8 in [3 mm], without freeplay) while starting the engine.

About 1/8 in (3 mm) without freeplay

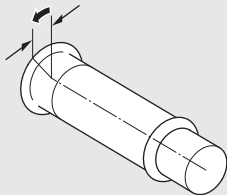

If the engine does not start:

- ① Open the throttle fully and press the start button for 5 seconds.
- ② Repeat the normal starting procedure.
- ③ If the engine starts, open the throttle slightly if idling is unstable.
- ④ If the engine does not start, wait 10 seconds before trying steps ① & ② again.

If Engine Will Not Start ➔ P.79

Shifting Gears

Your vehicle transmission has 6 forward gears in a one-down, five-up shift pattern.

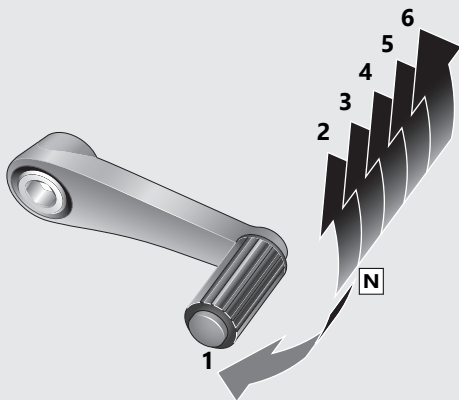

If you put the vehicle in gear with the side stand down, the engine will shut off.

Recommended Shift Points

Shifting Up

From 1st to 2nd	12 mph (20 km/h)
From 2nd to 3rd	19 mph (30 km/h)
From 3rd to 4th	25 mph (40 km/h)
From 4th to 5th	31 mph (50 km/h)
From 5th to 6th	37 mph (60 km/h)

Shifting Down

From 6th to 5th	28 mph (45 km/h)
From 5th to 4th	22 mph (35 km/h)
From 4th to 3rd	16 mph (25 km/h)

NOTICE

Improper shifting can damage the engine, transmission, and drive train. Also, coasting or towing the vehicle for long distances with the engine off can damage the transmission.

Refueling

Fuel fill cap

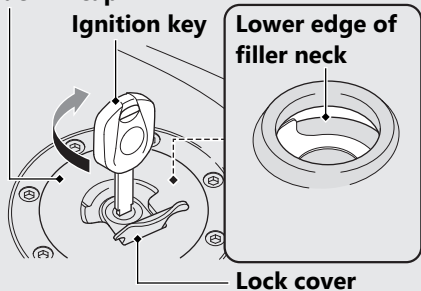

Do not fill with fuel above the lower edge of the filler neck.

Fuel type: Unleaded gasoline only

Recommended fuel octane number:

Pump Octane Number (PON) 91 or higher.

Tank capacity: 4.76 US gal (18.0 L)

Refueling and Fuel Guidelines ➔ P.13

Opening the Fuel Fill Cap

Open the lock cover, insert the ignition key, and turn it clockwise to open the fuel fill cap.

Closing the Fuel Fill Cap

- 1 After refueling, push the fuel fill cap closed until it locks.
- 2 Remove the ignition key and close the lock cover.
 - ▶ The ignition key cannot be removed if the fuel fill cap is not locked.

⚠ WARNING

Gasoline is highly flammable and explosive. You can be burned or seriously injured when handling fuel.

- Stop the engine, and keep heat, sparks, and flames away.
- Only handle fuel outdoors.
- Wipe up spills immediately.

Storage Equipment

Helmet holders, a helmet set wire (in the tool kit), a tool kit, and document bag are located under the rear seat.

There is also space to store a U-shaped lock.

U-shaped lock

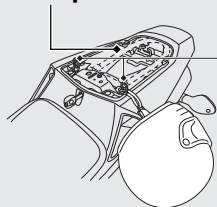

Helmet holder

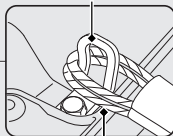

Helmet set wire

Tool kit

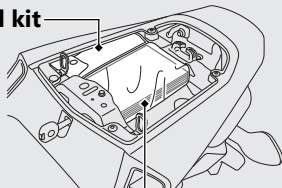

Document bag

- ▶ U-shaped lock is not included with this vehicle.
- ▶ The U-shaped lock is held in place above the rear fender.
- ▶ Use the helmet holder only when parked.
- ▶ Some U-shaped locks may not fit in the compartment due to their size or design.

Removing the Rear Seat → P.57

⚠ WARNING

Riding with a helmet attached to the holder can interfere with the rear wheel or suspension and could cause a crash in which you can be seriously hurt or killed.

Use the helmet holder only while parked. Do not ride with a helmet secured by the holder.

Maintenance

Please read "Importance of Maintenance" and "Maintenance Fundamentals" carefully before attempting any maintenance. Refer to "Specifications" for service data.

An optional larger tool kit may be available.

Check with your Honda dealer's parts department.

Importance of Maintenance	P. 33	Drive Chain	P. 66
Maintenance Schedule	P. 35	Clutch	P. 68
Maintenance Record	P. 38	Throttle	P. 71
Maintenance Fundamentals	P. 39	Other Adjustments	P. 72
Removing & Installing Body Components ..	P. 52	Adjusting the Brake Lever	P. 72
Battery	P. 52	Adjusting the Front Suspension.....	P. 73
Clip	P. 53	Adjusting the Rear Suspension	P. 75
Front Seat.....	P. 54		
Right Lower Cowl	P. 55		
Rear Seat	P. 57		
Engine Oil	P. 58		
Coolant	P. 60		
Brakes	P. 62		
Side Stand	P. 65		

Importance of Maintenance

Importance of Maintenance

Keeping your vehicle well-maintained is absolutely essential to your safety and to protect your investment, obtain maximum performance, avoid breakdowns, and reduce air pollution. Maintenance is the owner's responsibility. Be sure to inspect your vehicle before each ride and perform the periodic checks specified in the Maintenance Schedule.

➤ P. 35

⚠ WARNING

Improperly maintaining your vehicle or failing to correct a problem before you ride can cause a crash in which you can be seriously hurt or killed.

Always follow the inspection and maintenance recommendations and schedules in this owner's manual.

For information about the exhaust emission and noise emission requirements of the U.S. Environmental Protection Agency (EPA), and the California Air Resources Board (CARB). ➤ P. 100

Maintenance, replacement or repair of the emission control devices and systems may be performed by any vehicle repair establishment or individual using parts that are "certified" to EPA standards.

Maintenance Safety

Always read the maintenance instructions before you begin each task and make sure that you have the tools, parts, and skills required. We cannot warn you of every conceivable hazard that can arise in performing maintenance. Only you can decide whether or not you should perform a given task.

Follow these guidelines when performing maintenance.

- Stop the engine and remove the key.
- Place your vehicle on a firm, level surface using the side stand or a maintenance stand to provide support.
- Allow the engine, muffler, brakes, and other high-temperature parts to cool before servicing as you can get burned.
- Run the engine only when instructed, and do so in a well-ventilated area.

Maintenance Schedule

The maintenance schedule specifies the maintenance requirements necessary to ensure safe, dependable performance, and proper emission control.

Maintenance work should be performed in accordance with Honda's standards and specifications by properly trained and equipped technicians. Your dealer meets all of these requirements. All scheduled maintenance is considered a normal owner operating cost and will be charged to you by your dealer. Keeping an accurate maintenance record will help ensure your vehicle is properly maintained.

➤ P. 38

Make sure whoever performs the scheduled maintenance completes the maintenance record. Retain all service documents. If you sell your vehicle, these service documents should be transferred with the vehicle to the new owner.

Maintenance Schedule

Items		Frequency *1								Refer to page
		× 1,000 mi	0.6	4	8	12	16	20	24	
		× 1,000 km	1.0	6.4	12.8	19.2	25.6	32.0	38.4	
Fuel Line										-
Throttle Operation										71
Air Cleaner *2										-
Spark Plug		Every 16,000 mi (25,600 km):								-
Valve Clearance		Every 32,000 mi (51,200 km):								-
Engine Oil		Initial = 600 mi (1,000 km) or 1 month:								-
Engine Oil Filter		Regular = Every 8,000 mi (12,800 km) or 12 months:								-
Engine Oil Filter										-
Engine Idle Speed										-
Radiator Coolant *4										60
Cooling System										-
Secondary Air Supply System										-
Evaporative Emission Control System *3										-
Exhaust Gas Control Actuator Cable		Every 16,000 mi (25,600 km):								-

Maintenance Level





- : Intermediate. We recommend service by your dealer, unless you have the necessary tools and are mechanically skilled. Procedures are provided in an official Honda Service Manual (P. 107).
- : Technical. In the interest of safety, have your vehicle serviced by your dealer.

Emission-Related Maintenance

: Emission-Related Items

Maintenance Legend

- : Inspect (clean, adjust, lubricate, or replace, if necessary)
- : Replace
- : Lubricate

Items		Frequency *1								Refer to page
		× 1,000 mi	0.6	4	8	12	16	20	24	
		× 1,000 km	1.0	6.4	12.8	19.2	25.6	32.0	38.4	
Drive Chain		Every 500 mi (800 km): I L								66
Drive Chain Slider				I	I	I	I	I	I	–
Brake Fluid *4				I	I	R	I	I	R	62
Brake Pads Wear				I	I	I	I	I	I	63
Brake System			I		I		I		I	62
Brake Light Switch					I		I		I	64
Headlight Aim					I		I		I	–
Clutch System			I	I	I	I	I	I	I	68
Side Stand					I		I		I	65
Suspension					I		I		I	73, 75
Nuts, Bolts, Fasteners			I		I		I		I	–
Wheels/Tires					I		I		I	48
Steering Head Bearings			I		I		I		I	–

Notes:

*1: At higher odometer readings, repeat at the frequency interval established here.

*2: Service more frequently when riding in unusually wet or dusty areas.

*3: 50 STATE (meets California).

*4: Replace every 2 years, or at indicated odometer intervals, whichever comes first. Replacement requires mechanical skill.

Maintenance Record

Distance	Odometer	Date	Performed By:	Notes
600 miles (1,000 km)				
4,000 miles (6,400 km)				
8,000 miles (12,800 km)				
12,000 miles (19,200 km)				
16,000 miles (25,600 km)				
20,000 miles (32,000 km)				
24,000 miles (38,400 km)				
28,000 miles (44,800 km)				
32,000 miles (51,200 km)				
36,000 miles (57,600 km)				
40,000 miles (64,000 km)				
44,000 miles (70,400 km)				
48,000 miles (76,800 km)				
52,000 miles (83,200 km)				
56,000 miles (89,600 km)				
60,000 miles (96,000 km)				
64,000 miles (102,400 km)				
68,000 miles (108,800 km)				

Pre-ride Inspection

To ensure safety, it is your responsibility to perform a pre-ride inspection and make sure that any problem you find is corrected. A pre-ride inspection is a must, not only for safety, but because having a breakdown, or even a flat tire, can be a major inconvenience.

Check the following items before you get on your vehicle:

- Tire tread wear and air pressures are within limits ➤ P. 48
- Lights, horn, and turn signals operate normally
- Check the condition of the drive chain. Adjust slack and lubricate as needed ➤ P. 46

Check the following items if you are carrying a passenger or cargo:

- Combined weight is within load limits ➤ P. 114
- Cargo is secured properly
- Suspension is adjusted to suit load ➤ P. 73
➤ P. 75

Check the following items after you get on your vehicle:

- Throttle action moves smoothly without binding ➤ P. 71
- Brake lever and pedal operate normally
- Check the fuel level and refuel when needed
➤ P. 13, ➤ P. 30
- Engine stop switch functions properly
➤ P. 24

Check the following items at regular intervals:

- Oil level is between the upper and lower level marks ➤ P. 58
- Brake fluid level:

Front: between the UPPER and LOWER level marks ➤ P. 62

Rear: between the UPPER and LOWER level marks ➤ P. 62

- Engine coolant level is between the UPPER and LOWER level marks ➤ P. 60
- Side stand functions properly ➤ P. 65

Periodic Checks

You should also perform other periodic maintenance checks at least once a month regardless of how often you ride, or more often if you ride frequently.

Also, check the odometer reading against the Maintenance Schedule and perform all maintenance that is due. ➔ P. 35

Tires and wheels	Check the air pressure (➔ P. 48), examine tread for wear and damage (➔ P. 48), and check the wheels for damage.
Fluid levels	Check the engine oil level (➔ P. 58), engine coolant level (➔ P. 60), and brake fluid level (➔ P. 62).
Lights	Check that the headlight, brake light, taillight, turn signals, position lights, and license plate light are working properly.
Controls	Check the freeplay of the clutch lever (➔ P. 68), throttle grip (➔ P. 71).
Drive chain	Check the slack (➔ P. 66), adjust the slack, and lubricate (➔ P. 47) as needed.
Fuses	Check that you have a full supply of spare fuses.
Nuts & bolts	Check the major nuts and bolts, and tighten as needed.

Replacing Parts

Always use Honda Genuine Parts or their equivalents to ensure reliability and safety. When ordering colored components, specify the model name, color, and code mentioned on the color label.

The color label is attached to the rear fender under the rear seat. ➤ P. 57

Color label

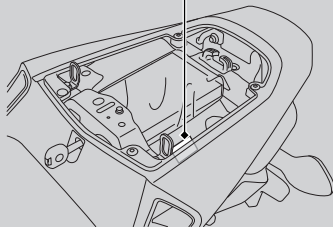

⚠WARNING

Installing non-Honda parts may make your vehicle unsafe and cause a crash in which you can be seriously hurt or killed.

Always use Honda Genuine Parts or equivalents that have been designed and approved for your vehicle.

Battery

Your vehicle has a maintenance-free type battery. You do not have to check the battery electrolyte level or add distilled water. Clean the battery terminals if they become dirty or corroded.

Do not remove the battery cap seals. There is no need to remove the cap when charging.



This symbol on the battery means that this product must not be treated as household waste.

NOTICE

An improperly disposed of battery can be harmful to the environment and human health. Always confirm local regulations for proper battery disposal instruction.

What to do in an emergency

If any of the following occur, immediately see your doctor.

- Electrolyte splashes into your eyes:
 - ▶ Wash your eyes repeatedly with cool water for at least 15 minutes. Using water under pressure can damage your eyes.

- Electrolyte splashes onto your skin:
 - ▶ Remove affected clothing and wash your skin thoroughly using water.
- Electrolyte splashes into your mouth:
 - ▶ Rinse mouth thoroughly with water, and do not swallow.

WARNING

The battery gives off explosive hydrogen gas during normal operation.

A spark or flame can cause the battery to explode with enough force to kill or seriously hurt you.

Wear protective clothing and a face shield, or have a skilled mechanic do the battery servicing.

WARNING: Battery posts, terminals, and related accessories contain lead and lead compounds.
Wash your hands after handling.

Cleaning the Battery Terminals

1. Remove the battery. ➔ P. 52
2. If the terminals are starting to corrode and are coated with a white substance, wash with warm water and wipe clean.
3. If the terminals are heavily corroded, clean and polish the terminals with a wire brush or sandpaper. Wear safety glasses.

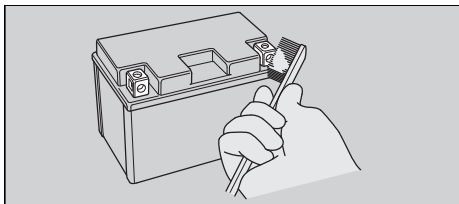

4. After cleaning, reinstall the battery.

The battery has a limited life span. Consult your dealer about when you should replace the battery. Always replace the battery with another maintenance-free battery of the same type.

Charging

If you use electrical accessories that drain the battery or you do not ride frequently, we recommend that you charge the battery every 30 days using a charger designed specifically for your Honda, which can be purchased from your dealer. Read the information that came with your battery charger and follow the instructions on the battery. Avoid using an automobile-type battery charger, as these can overheat a motorcycle battery and cause permanent damage.

Make sure the ignition switch is in the OFF position before charging the battery.

NOTICE

Improper charging can damage the battery. If you can't charge the battery or it appears unable to hold a charge, contact your dealer.

NOTICE

Jump starting using an automobile battery can damage your vehicle's electrical system and is not recommended. Bump starting is also not recommended.

NOTICE

Installing non-Honda electrical accessories can overload the electrical system, discharging the battery and possibly damaging the system.

Fuses

Fuses protect the electrical circuits on your vehicle. If something electrical on your vehicle stops working, check for and replace any blown fuses. ➤ P. 88

Inspecting and Replacing Fuses

Turn the ignition switch to the OFF position to remove and inspect fuses. If a fuse is blown, replace with a fuse of the same rating. For fuse ratings, see "Specifications." ➤ P. 116

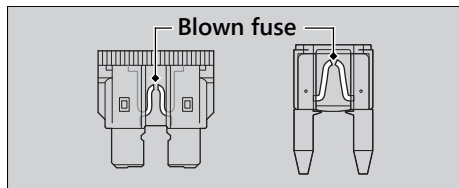

NOTICE

Replacing a fuse with one that has a higher rating greatly increases the chance of damage to the electrical system.

If a fuse fails repeatedly, you likely have an electrical fault. Have your vehicle inspected by your dealer.

Engine Oil

Engine oil consumption varies and oil quality deteriorates according to riding conditions and time elapsed.

Check the engine oil level regularly, and add the recommended engine oil if necessary. Dirty oil or old oil should be changed as soon as possible.

Selecting the Engine Oil

For recommended engine oil, see “Specifications.” P. 115

If you use non-Honda engine oil, check the label to make sure that the oil satisfies all of the following standards:

- JASO T 903 standard^{*1}: MA
- SAE standard^{*2}: 10W-30
- API classification^{*3}: SJ or higher

- ^{*1}. The JASO T 903 standard is an index for engine oils for 4-stroke motorcycle engines. There are two classes: MA and MB. For example, the following label shows the MA classification.

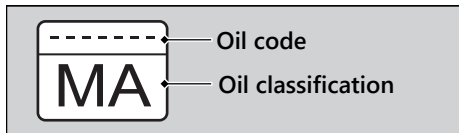

- ^{*2}. The SAE standard grades oils by their viscosity.
- ^{*3}. The API classification specifies the quality and performance rating of engine oils. Use SJ or higher oils, excluding oils marked as “Energy Conserving” or “Resource Conserving” on the circular API service symbol.

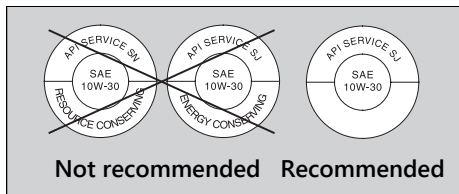

Brake Fluid

Do not add or replace brake fluid, except in an emergency. Use only fresh brake fluid from a sealed container. If you do add fluid, have the brake system serviced by your dealer as soon as possible.

NOTICE

Brake fluid can damage plastic and painted surfaces. Wipe up spills immediately and wash thoroughly.

Recommended brake fluid:

Honda DOT 4 Brake Fluid or equivalent

Drive Chain

The drive chain must be inspected and lubricated regularly. Inspect the chain more frequently if you often ride on bad roads, ride at high speed, or ride with repeated fast acceleration. ➤ P. 66

If the chain does not move smoothly, makes strange noises, has damaged rollers, has loose pins, has missing O-rings, or has kinks, have the chain inspected by your dealer.

Also inspect the drive sprocket and driven sprocket. If either has worn or damaged teeth, have the sprocket replaced by your dealer.

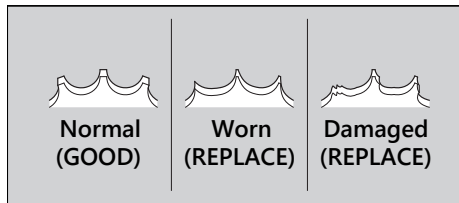

NOTICE

Use of a new chain with worn sprockets will cause rapid chain wear.

I Cleaning and Lubricating

After inspecting the slack, clean the chain and sprockets while rotating the rear wheel. Use a dry cloth with chain cleaner designed specifically for O-ring chains, or neutral detergent. Use a soft brush if the chain is dirty.

After cleaning, wipe dry and lubricate with the recommended lubricant.

Recommended lubricant:

Pro Honda HP Chain Lube or equivalent

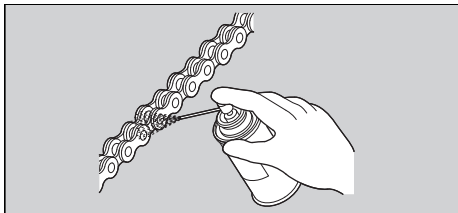

Do not use a steam cleaner, a high pressure cleaner, a wire brush, volatile solvent such as gasoline and benzene, abrasive cleaner, chain

cleaner or lubricant NOT designed specifically for O-ring chains as these can damage the rubber O-ring seals.

Avoid getting lubricant on the brakes or tires.

Avoid applying excess chain lubricant to prevent spray onto your clothes and the vehicle.

Recommended Coolant

Pro Honda HP Coolant is a pre-mixed solution of antifreeze and distilled water.

Concentration:

50% antifreeze and 50% distilled water

A concentration of antifreeze below 40% will not provide proper corrosion and cold temperature protection.

A concentration of up to 60% will provide better protection in colder climates.

NOTICE

Using coolant not specified for aluminum engines or tap/mineral water can cause corrosion.

Tires (Inspecting/Replacing)

Checking the Air Pressure

Visually inspect your tires and use an air pressure gauge to measure the air pressure at least once a month or any time you think the tires look low. Always check air pressure when your tires are cold.

Inspecting for Damage

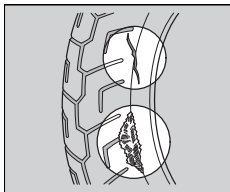

Inspect the tires for cuts, slits, or cracks that expose fabric or cords, or nails or other foreign objects embedded in the side of the tire or the tread.

Also inspect for any unusual bumps or bulges in the side walls of the tires.

Inspecting for Abnormal Wear

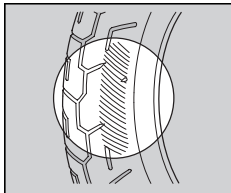

Inspect the tires for signs of abnormal wear on the contact surface.

Inspecting Tread Depth

Inspect the tread wear indicators. If they become visible, replace the tires immediately. For safe riding, you should replace the tires when the minimum tread depth is reached.

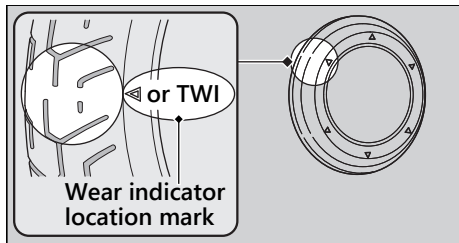

⚠️ WARNING

Riding on tires that are excessively worn or improperly inflated can cause a crash in which you can be seriously hurt or killed.

Follow all instructions in this owner's manual regarding tire inflation and maintenance.

Maintenance Fundamentals

Have your tires replaced by your dealer. For recommended tires, air pressure, and minimum tread depth, see "Specifications."

➤ P. 115

Follow these guidelines whenever you replace tires:

- Use the recommended tires or their equivalents of the same size, construction, speed rating, and load range.
- Have the wheel balanced with Honda Genuine balance weights or equivalent after the tire is installed.
- Do not install a tube inside a tubeless tire on this vehicle. Excessive heat build-up can cause the tube to burst.
- Use only tubeless tires on this vehicle. The rims are designed for tubeless tires, and during hard acceleration or braking, a tube-type tire could slip on the rim and cause the tire to rapidly deflate.

WARNING

Installing improper tires on your vehicle can adversely affect handling and stability, and can cause a crash in which you can be seriously hurt or killed.

Always use the size and type of tires recommended in this owner's manual.

Tire Service Life

The service life of your tires is dependent on many factors, including, but not limited to, riding habits, road conditions, vehicle loading, tire air pressure, maintenance history, speed, and environmental conditions (even when the tires are not in use).

In addition to your regular inspections and maintenance, it is recommended that you have annual inspections performed once the tires reach 5 years old. It is also recommended that all tires be removed from service after 10 years from the date of manufacture, regardless of their condition or state of wear.

The last four digits of the TIN (tire identification number) indicate the date of manufacture.

Tire Identification Number (TIN)

The tire identification number (TIN) is a group of numbers and letters located on the sidewall of the tire.

① ② ③

DOT XXXX XXXX 20 23

DOT: This indicates that the tire meets all requirements of the U.S. Department of Transportation.

- ① XXXX: Factory code
- ② XXXX: Tire type code
- ③ 20 23: Date of manufacture (week & year).
Example: week 20 in year 23.

Tire Labeling Example

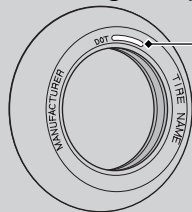

Tire identification number (TIN)

Battery

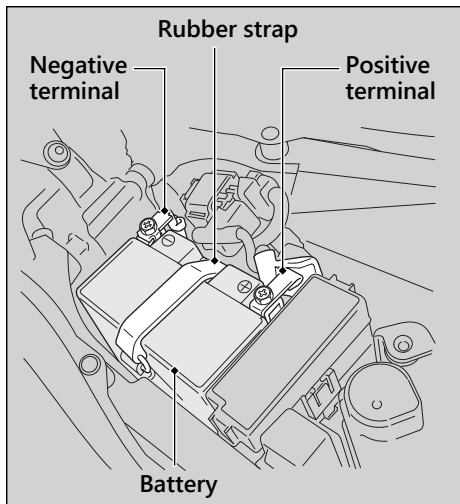

Removal

Make sure the ignition switch is in the OFF position.

1. Remove the front seat. ➤ P. 54
2. Unhook the rubber strap.
3. Disconnect the negative \ominus terminal from the battery.
4. Disconnect the positive \oplus terminal from the battery.
5. Remove the battery, taking care not to drop the terminal nuts.

Installation

Install the parts in the reverse order of removal. Always connect the positive \oplus terminal first. Make sure bolts and nuts are tight.

Make sure the clock information is correct after the battery is reconnected. ➤ P. 21
For proper handling of the battery, see "Maintenance Fundamentals." ➤ P. 42
"Battery Goes Dead." ➤ P. 85

Clip

Removal

1. Remove the pin by a Phillips screwdriver.
2. Pull the clip out of the hole.

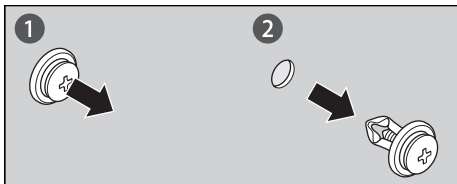

Installation

1. Insert the clip into the hole.
2. Push the pin in.

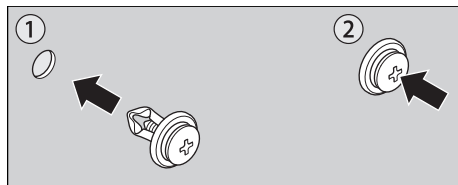

Front Seat

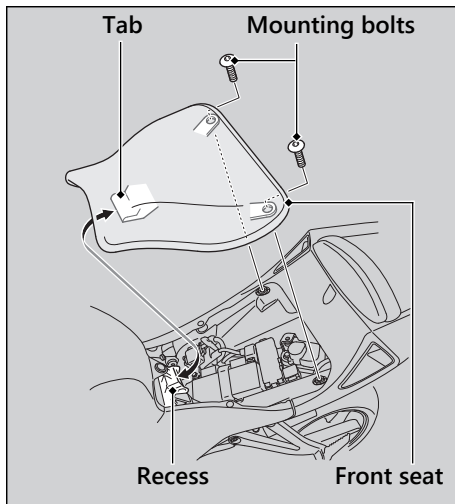

Removal

1. Pull the rear corners of the front seat up, then remove the mounting bolts.
2. Pull the front seat back and up.

Installation

1. Insert the tab into the recess.
2. Install and tighten the mounting bolts securely.
Make sure that the seat is locked securely in position by pulling it up lightly.

Right Lower Cowl

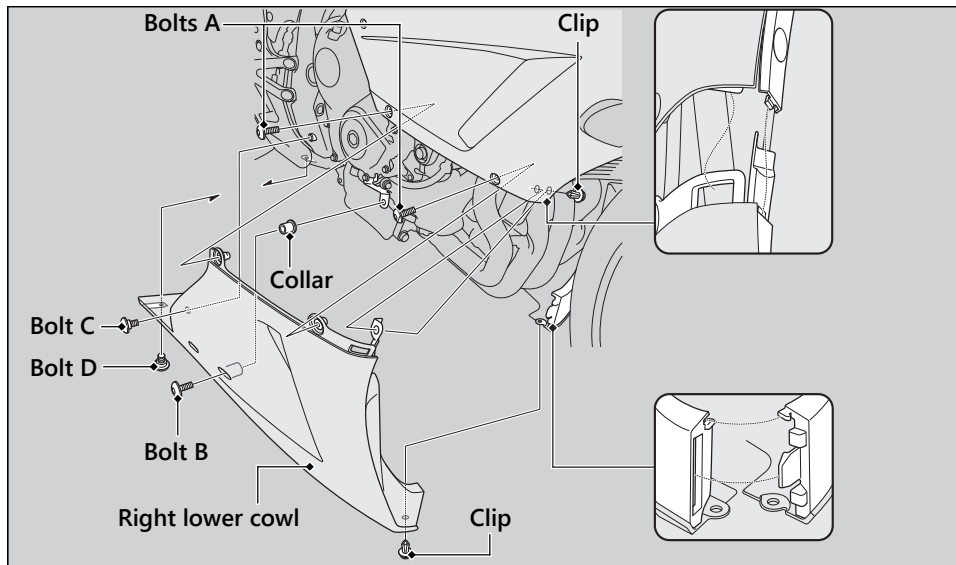

■ Removal

1. Remove the bolts A, bolt B, bolt C, bolt D, collar and clips. ► P. 53
2. Remove the right lower cowl.

■ Installation

Install the parts in the reverse order of removal.

Rear Seat

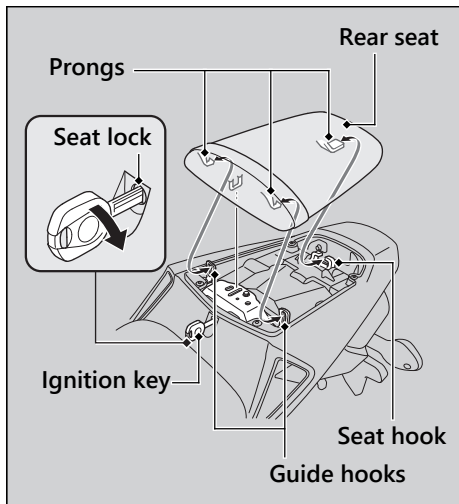

Removal

1. Insert the ignition key into the seat lock.
2. Turn it clockwise, then pull the rear seat forward and up.

Installation

1. Insert the prongs into the seat hook and guide hooks.
2. Push down on the front of the rear seat. Make sure that the seat is locked securely in position by pulling it up lightly. The seat locks automatically when closed. Take care not to lock your key in the compartment under the rear seat.

Checking the Engine Oil

1. If the engine is cold, idle the engine for 3 to 5 minutes.
2. Turn the ignition switch to the OFF position and wait for 2 to 3 minutes.
3. Place your vehicle in an upright position on a firm, level surface.
4. Check that the oil level is between the upper level and lower level marks on the oil level inspection window.

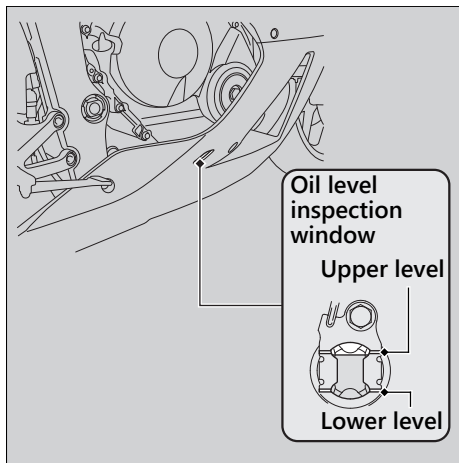

Adding Engine Oil

If the engine oil is below or near the lower level mark, add the recommended engine oil.

➤ P. 45, ➤ P. 115

1. Remove the oil fill cap. Add the recommended oil until it reaches the upper level mark.
 - Place your vehicle in an upright position on a firm, level surface when checking the oil level.
 - Do not overfill above the upper level mark.
 - Make sure no foreign objects enter the oil filler opening.
 - Wipe up any spills immediately.

2. Securely reinstall the oil fill cap.

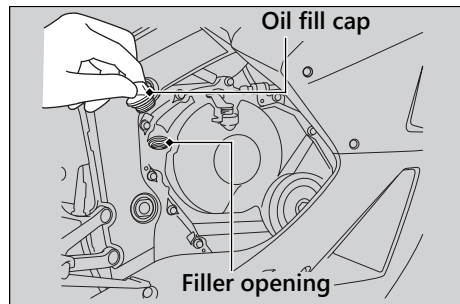

NOTICE

Overfilling with oil or operating with insufficient oil can cause damage to your engine. Do not mix different brands and grades of oil. They may affect lubrication and clutch operation.

For the recommended oil and oil selection guidelines, see "Maintenance Fundamentals."

➤ P. 45

Checking the Coolant

Check the coolant level in the reserve tank while the engine is cold.

1. Place your vehicle on a firm, level surface.
2. Hold your vehicle in an upright position.
3. Check that the coolant level is between the UPPER level and LOWER level marks on the reserve tank.

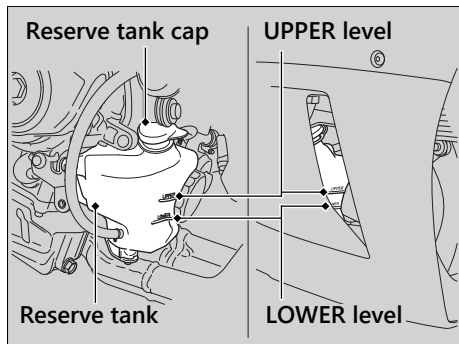

If the coolant level is dropping noticeably or the reserve tank is empty, you likely have a serious leak. Have your vehicle inspected by your dealer.

Adding Coolant

If the coolant level is below the LOWER level mark, add the recommended coolant (► P. 48) until the level reaches the UPPER level mark.

Add fluid only from the reserve tank cap and do not remove the radiator cap.

1. Remove the right lower cowl. ► P. 55
2. Remove the reserve tank cap and add fluid while monitoring the coolant level.
 - Do not overfill above the UPPER level mark.
 - Make sure no foreign objects enter the reserve tank opening.
3. Securely reinstall the reserve tank cap.
4. Install the right lower cowl.

WARNING

Removing the radiator cap while the engine is hot can cause the coolant to spray out, potentially scalding you.

Always let the engine and radiator cool down before removing the radiator cap.

Checking Brake Fluid

1. Place your vehicle in an upright position on a firm, level surface.
2. Check that the brake fluid reservoir is horizontal and that the fluid level is between the LOWER level and UPPER level marks.

If the brake fluid level in either reservoir is below the LOWER level mark or the brake lever and pedal freeplay becomes excessive, inspect the brake pads for wear. If the brake pads are not worn, you most likely have a leak. Have your vehicle inspected by your dealer.

Front

Front brake fluid reservoir

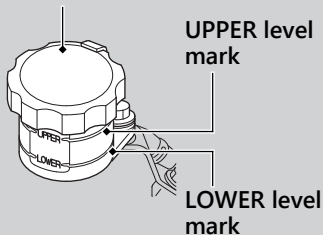

Rear

Rear brake fluid reservoir

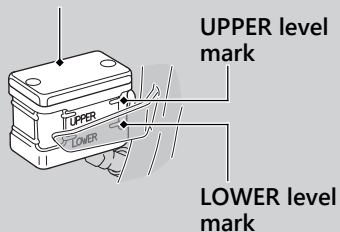

Inspecting the Brake Pads

Check the condition of the brake pad wear indicators.

Front The pads need to be replaced if a brake pad is worn to the bottom of the indicator.

Rear The pads need to be replaced if a brake pad is worn to the indicator.

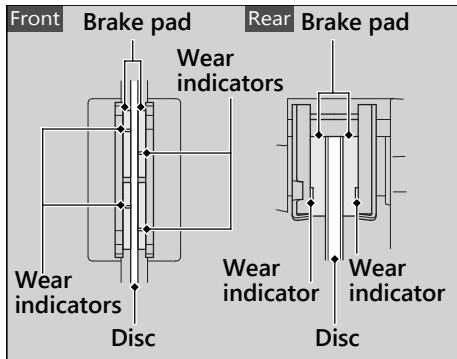

1. **Front** Inspect the brake pads from in front of the brake caliper.
 - Always inspect both left and right brake calipers.

If necessary, have the pads replaced by your dealer.

2. **Rear** Inspect the brake pads from the rear right of the vehicle.

If necessary, have the pads replaced by your dealer.

Always replace both left and right brake pads at the same time.

Adjusting the Brake Light Switch

Check the operation of the brake light switch. Hold the brake light switch and turn the adjusting nut in the direction A if the switch operates too late, or turn the nut in the direction B if the switch operates too soon.

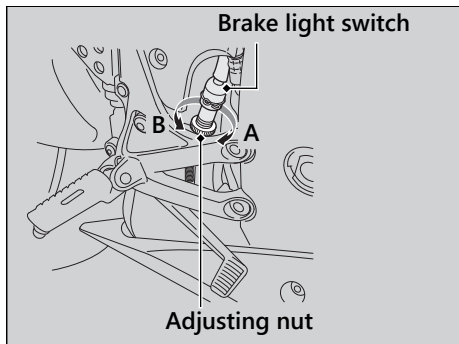

Checking the Side Stand

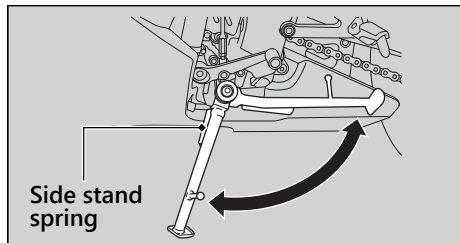

1. Check that the side stand operates smoothly. If the side stand is stiff or squeaky, clean the pivot area and lubricate the pivot bolt with clean grease.
2. Check the spring for damage or loss of tension.
3. Sit on the vehicle, shift the transmission to Neutral, and raise the side stand.
4. Start the engine, pull the clutch lever in, and shift the transmission into gear.
5. Lower the side stand all the way. The engine should stop as you lower the side stand. If the engine doesn't stop, have your vehicle inspected by your dealer.

Inspecting the Drive Chain Slack

Check the drive chain slack at several points along the chain. If the slack is not constant at all points, some links may be kinked and binding.

Have the chain inspected by your dealer.

1. Shift the transmission to Neutral. Stop the engine.
2. Place your vehicle on its side stand on a firm, level surface.
3. Check the slack in the lower half of the drive chain midway between the sprockets.

Drive chain slack:

1 3/16 - 1 9/16 in (30 - 40 mm)

- ▶ Do not ride your vehicle if the slack exceeds 1 15/16 in (50 mm).

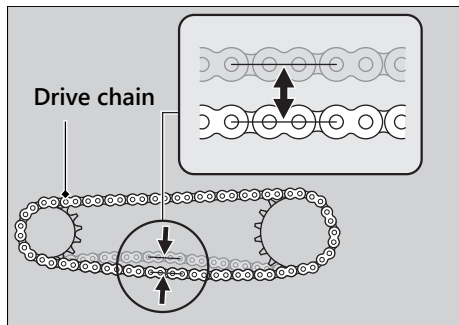

4. Roll the vehicle forward and check that the chain moves smoothly.
5. Inspect the sprockets. ➤ P. 46
6. Clean and lubricate the drive chain. ➤ P. 47

Checking the Drive Chain Slider

Check the condition of the drive chain slider.

The drive chain slider will need to be replaced if the chain slider is worn to the wear limit line.

If necessary, have the drive chain slider replaced by your dealer.

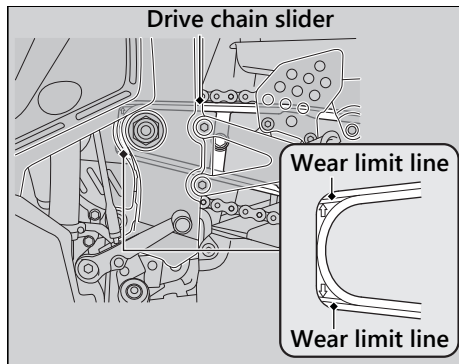

Checking the Clutch

Checking the Clutch Lever Freeplay

Check the clutch lever freeplay.

Freeplay at the clutch lever:

3/8 - 13/16 in (10 - 20 mm)

Check the clutch cable for kinks or signs of wear. If necessary, have it replaced by your dealer.

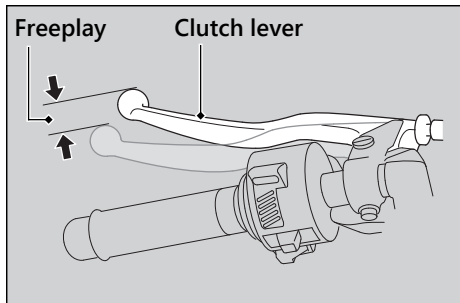

Check the clutch cable for kinks or signs of wear. If necessary, have it replaced by your dealer.

Lubricate the clutch cable with a commercially available cable lubricant to prevent premature wear and corrosion.

NOTICE

Improper freeplay adjustment can cause premature clutch wear.

Adjusting the Clutch Lever Freeplay

Upper Adjustment

Attempt adjustment with the upper clutch cable adjuster first.

1. Loosen the upper lock nut.
2. Turn the upper clutch cable adjuster until the freeplay is $\frac{3}{8}$ - $\frac{13}{16}$ in (10 - 20 mm).
3. Tighten the upper lock nut and check the freeplay again.

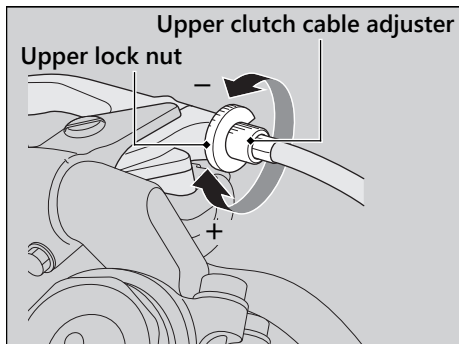

Lower Adjustment

If the upper clutch cable adjuster is threaded out near its limit, or the correct freeplay cannot be obtained, attempt adjustment with the lower clutch cable adjusting nut.

Clutch ► **Adjusting the Clutch Lever Freeplay**

1. Loosen the upper lock nut and turn the upper clutch cable adjuster all the way in (to provide maximum freeplay). Tighten the upper lock nut.
2. Loosen the lower lock nut.
3. Turn the lower adjusting nut until the clutch lever freeplay is $\frac{3}{8}$ - $\frac{13}{16}$ in (10 - 20 mm).
4. Tighten the lower lock nut and check the clutch lever freeplay.
5. Start the engine, pull the clutch lever in, and shift into gear. Make sure the engine does not stall and the vehicle does not creep. Gradually release the clutch lever and open the throttle. Your vehicle should move smoothly and accelerate gradually.

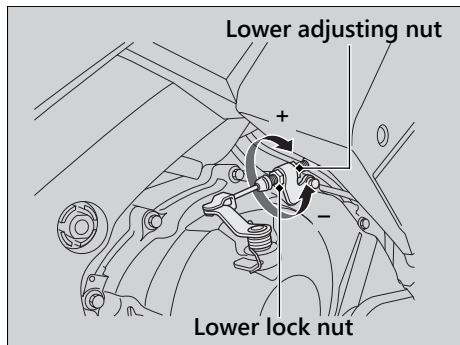

If proper adjustment cannot be obtained or the clutch does not work correctly, see your dealer.

Checking the Throttle

With the engine off, check that the throttle rotates smoothly from fully closed to fully open in all steering positions and throttle freeplay is correct. If the throttle does not move smoothly or close automatically, or if the cable is damaged, have the vehicle inspected by your dealer.

Freeplay at the throttle grip flange:

1/16 - 3/16 in (2 - 4 mm)

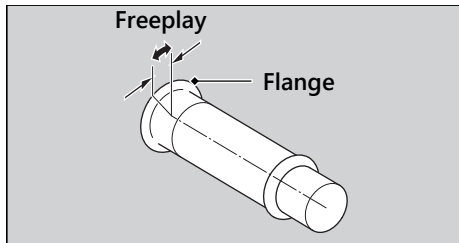

Adjusting the Throttle Freeplay

1. Slide the cable boot.
2. Loosen the lock nut.
3. Turn the adjuster until the freeplay is 1/16 - 3/16 in (2 - 4 mm).
4. Tighten the lock nut, return the cable boot, and inspect the throttle action again.

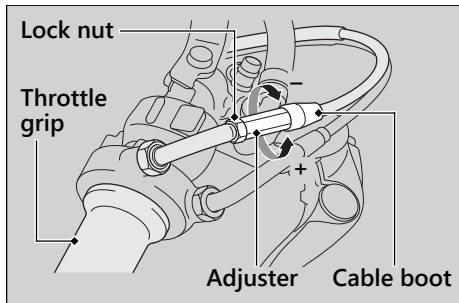

Adjusting the Brake Lever

You can adjust the distance between the brake lever and handle grip.

Adjustment method

Turn the adjuster until the numbers align with the index mark while pushing the lever forward in the desired position.

After adjustment, check that the lever operates correctly before riding.

NOTICE

Do not turn the adjuster beyond its natural limit.

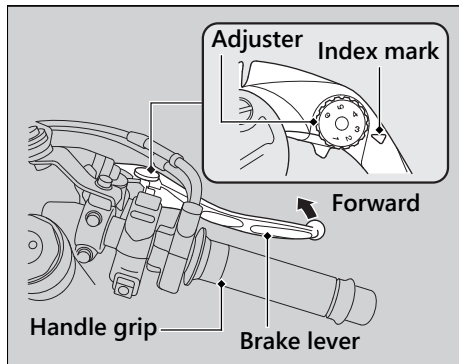

Adjusting the Front Suspension

Spring Preload

You can adjust the spring preload by the adjuster to suit the load or the road surface. Turn clockwise to increase spring preload (high), or turn counterclockwise to decrease spring preload (low). The standard position is 4 1/2 turns from the minimum setting.

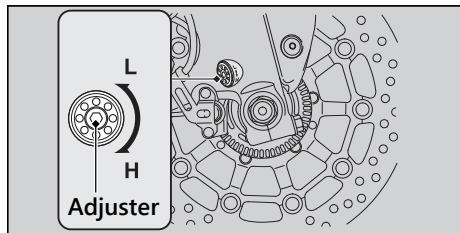

NOTICE

Do not turn the adjuster beyond its limits. Adjust both left and right forks to the same spring preload.

Rebound Damping

You can adjust the rebound damping by the TEN adjuster to suit the load or the road surface.

Turn clockwise to increase rebound damping (hard), or turn counterclockwise to decrease rebound damping (soft). The standard position is 4 1/4 turns from the maximum setting.

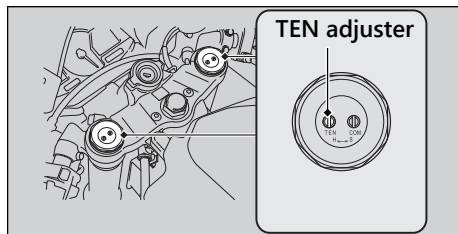

NOTICE

Do not turn the adjuster beyond its limits. Adjust both left and right forks to the same rebound damping.

Compression Damping

You can adjust the compression damping by the COM adjuster to suit the load or the road surface.

Turn clockwise to increase compression damping (hard), or turn counterclockwise to decrease compression damping (soft). The standard position is 5 1/2 turns from the maximum setting.

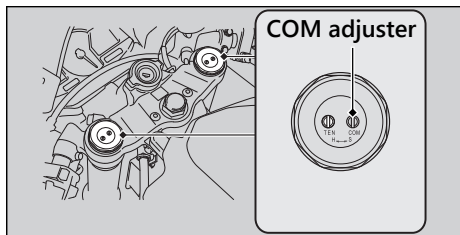

NOTICE

Do not turn the adjuster beyond its limits. Adjust both left and right forks to the same compression damping.

Adjusting the Rear Suspension

Adjusting the suspension requires a pin spanner. We recommend that you have your vehicle serviced by your dealer.

Spring Preload

You can adjust the spring preload by the adjuster to suit the load or the road surface. Use the pin spanner and extension bar to turn the adjuster. Position 1 is for decreased spring preload (low). Positions 3 to 10 increase spring preload (high). The standard position is 2.

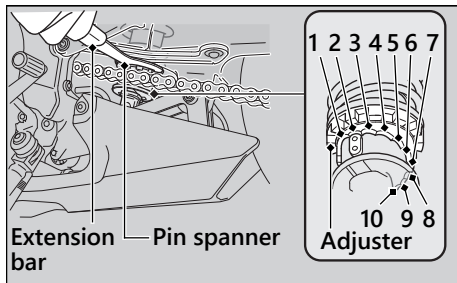

NOTICE

Attempting to adjust directly from 1 to 10 or 10 to 1 may damage the shock absorber.

NOTICE

Do not turn the adjuster beyond its limits.

NOTICE

The rear shock absorber damper unit contains high pressure nitrogen gas. Do not attempt to disassemble, service, or improperly dispose of the damper. See your dealer.

Rebound Damping

You can adjust the rebound damping by the adjuster to suit the load or the road surface. Turn clockwise to increase rebound damping (hard), or turn counterclockwise to decrease rebound damping (soft). The standard position is 2 3/4 turns from the maximum setting so that the punch mark on the adjuster aligns with the reference punch mark.

NOTICE

Do not turn the adjuster beyond its limits.

NOTICE

The rear shock absorber damper unit contains high pressure nitrogen gas. Do not attempt to disassemble, service, or improperly dispose of the damper. See your dealer.

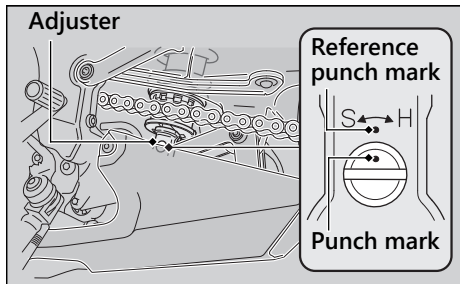

Compression Damping

You can adjust the compression damping by the adjuster to suit the load or the road surface. Turn clockwise to increase compression damping (hard), or turn counterclockwise to decrease compression damping (soft). The standard position is 18 clicks from the maximum setting so that the punch mark on the adjuster aligns with the reference punch mark.

CBR600RR

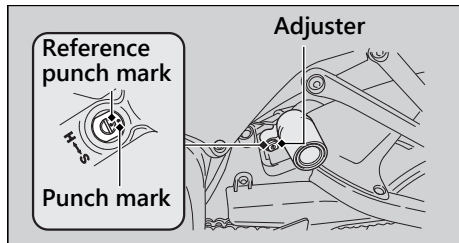

CBR600RA

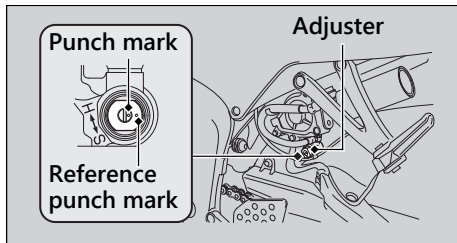

NOTICE

Do not turn the adjuster beyond its limits.

NOTICE

The rear shock absorber damper unit contains high pressure nitrogen gas. Do not attempt to disassemble, service, or improperly dispose of the damper. See your dealer.

Troubleshooting

Engine Will Not Start	P. 79	Battery Goes Dead	P. 85
Overheating (High coolant temperature indicator is on)	P. 80	Burned-out Light Bulb.....	P. 85
Warning Indicators On or Flashing	P. 81	Blown Fuse	P. 88
Low Oil Pressure Indicator	P. 81		
PGM-FI (Programmed Fuel Injection)			
Malfunction Indicator Lamp (MIL)	P. 81		
Combined ABS Indicator	P. 82		
HESD (Honda Electronic Steering Damper)			
Indicator.....	P. 82		
Other Warning Indications	P. 83		
Fuel Gauge Failure Indication.....	P. 83		
Tire Puncture	P. 84		
Electrical Trouble	P. 85		

Starter Motor Operates But Engine Does Not Start

Check the following items:

- Make sure engine stop switch is in the  (Run) position. ➤ P. 24
- Check the correct engine starting sequence. ➤ P. 27
- Check that there is gasoline in the fuel tank.
- Check if the PGM-FI malfunction indicator lamp (MIL) is on.
 - ▶ If the indicator lamp is on, contact your dealer as soon as possible.

Starter Motor Does Not Operate

Check the following items:

- Check the correct engine starting sequence. ➤ P. 27
- Check for a blown fuse. ➤ P. 88
- Check for a loose battery connection (➤ P. 52) or battery terminal corrosion (➤ P. 42).
- Check the condition of the battery. ➤ P. 85

If the problem continues, have your vehicle inspected by your dealer.

Overheating (High coolant temperature indicator is on)

The engine is overheating when the following occurs:

- High coolant temperature indicator comes on.
- Acceleration becomes sluggish.

If this occurs, pull safely to the side of the road and perform the following procedure. Extended fast idling may cause the high coolant temperature indicator to come on.

NOTICE

Continuing to ride with an overheated engine can cause serious damage to the engine.

1. Stop the engine using the ignition switch, and then turn the ignition switch to the ON position.

2. Check that the radiator fan is operating, and then turn the ignition switch to the OFF position.

If the fan is not operating:

Suspect a fault. Do not start the engine. Transport your vehicle to your dealer.

If the fan is operating:

Allow the engine to cool with the ignition switch in the OFF position.

3. After the engine has cooled, inspect the radiator hose and check if there is a leak.

➔ P. 60

If there is a leak:

Do not start the engine. Transport your vehicle to your dealer.

4. Check the coolant level in the reserve tank. ➔ P. 60
▶ Add coolant as necessary.
5. If 1-4 check normal, you may continue riding, but closely monitor the temperature gauge.

Low Oil Pressure Indicator

If the low oil pressure indicator comes on, pull safely to the side of the road and stop the engine.

NOTICE

Continuing to ride with low oil pressure can cause serious damage to the engine.

1. Check the engine oil level, and add oil as necessary. 📄 P. 58, 📄 P. 59
2. Start the engine.
 - ▶ Only continue riding if the low oil pressure indicator goes off.

Rapid acceleration may momentarily cause the low oil pressure indicator to come on, especially if the oil is at or near the low level. If the low oil pressure indicator stays on when the oil level is at the proper level, stop the engine and contact your dealer.

If the engine oil level goes down rapidly, your vehicle may have a leak or another serious problem. Have your vehicle inspected by your dealer.

PGM-FI (Programmed Fuel Injection) Malfunction Indicator Lamp (MIL)

If the indicator comes on while riding, you may have a serious problem with the PGM-FI system. Reduce speed and have your vehicle inspected by your dealer as soon as possible.

Combined ABS Indicator

CBR600RA

If the Combined ABS indicator operates in one of the following ways, your brakes will continue to work as a conventional system, but without the Combined ABS function. Reduce your speed and have your vehicle inspected by your dealer as soon as possible.

- Indicator does not come on when the ignition switch is in the ON position.
- Indicator does not go off at speeds above 6 mph (10 km/h)
- Indicator comes on or starts flashing while riding

The Combined ABS indicator may flash if:

- The front wheel leaves the ground for 1 second or more
- Either brake is applied continuously from 0 mph (0 km/h) to 31 mph (50 km/h)
- You turn the rear wheel while your vehicle is lifted off the ground

This is normal but the Combined ABS is not in operation. To activate the system again, turn the ignition switch to the OFF position, and then to the ON position again.

HESD (Honda Electronic Steering Damper) Indicator

If the indicator comes on while riding, you may have a serious problem with the HESD. Reduce speed and have your vehicle inspected by your dealer as soon as possible.

Fuel Gauge Failure Indication

If the fuel system has an error, the fuel gauge indicators will be displayed as shown in the illustration.

If these occur, see your dealer as soon as possible.

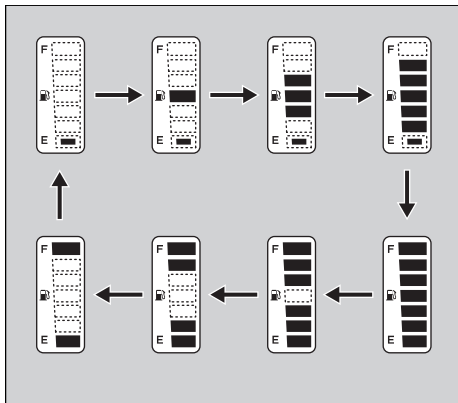

Tire Puncture

Repairing a puncture or removing a wheel requires special tools and technical expertise. We recommend you have this type of service performed by your dealer.

After an emergency repair, always have the tire inspected/replaced by your dealer.

Emergency Repair Using a Tire Repair Kit

If your tire has a minor puncture, you can make an emergency repair using a tubeless tire repair kit.

Follow the instructions provided with the emergency tire repair kit.

Riding your vehicle with a temporary tire repair is very risky. Do not exceed 30 mph (50 km/h). Have the tire replaced by your dealer as soon as possible.

WARNING

Riding your vehicle with a temporary tire repair can be risky. If the temporary repair fails, you can crash and be seriously injured or killed.

If you must ride with a temporary tire repair, ride slowly and carefully and do not exceed 30 mph (50 km/h) until the tire is replaced.

Battery Goes Dead

Charge the battery using a motorcycle battery charger.

Remove the battery from the vehicle before charging.

Do not use an automobile-type battery charger, as these can overheat a motorcycle battery and cause permanent damage. If the battery does not recover after recharging, contact your dealer.

NOTICE

Jump starting using an automobile battery can damage your vehicle's electrical system and is not recommended.

Bump starting is also not recommended.

Burned-out Light Bulb

Follow the procedure below to replace a burned-out light bulb.

Turn the ignition switch to the OFF or LOCK position.

Allow the bulb to cool before replacing it.

Do not use bulbs other than those specified.

Check the replacement bulb for correct operation before riding.

For the light bulb wattage, see "Specifications." ➔ P. 116

The brake light and taillight uses several LEDs.

If there is an LED which is not turned on, see your dealer for servicing.

Headlight Bulb

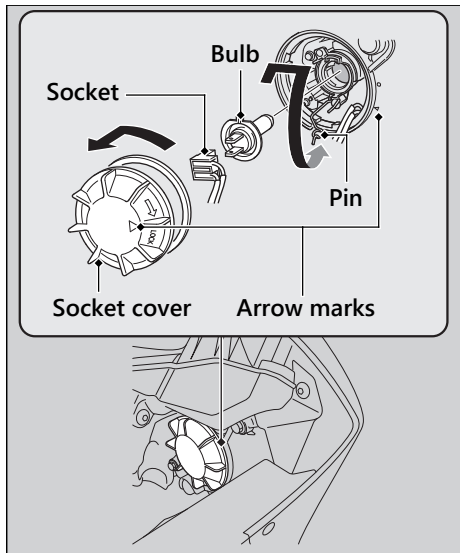

1. Remove the socket cover by turning it counterclockwise.
2. Pull the socket off the bulb without turning it.
3. Press the pin down and pull out the bulb without turning it.
4. Install a new bulb and reinstall the parts in the reverse order of removal.
 - Make sure the arrow marks on the socket cover and headlight housing are aligned.

Do not touch the glass surface with your fingers. If you touch the bulb with your bare hands, clean it with a cloth moistened with isopropyl (rubbing) alcohol.

Front/Rear Turn Signal/Position Light Bulb

1. Remove the screw.
2. Remove the turn signal/position light lens and lens packing.
3. Slightly press the bulb and turn it counterclockwise.

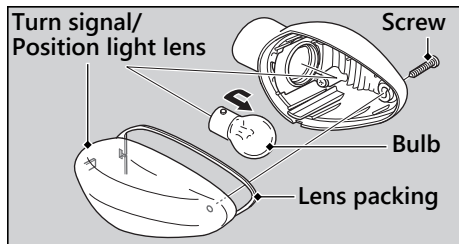

4. Install a new bulb and reinstall the parts in the reverse order of removal.

License Plate Light Bulb

1. Remove the screws, license light cover and license light cover packing.
2. Pull the bulb out of the socket without turning it.

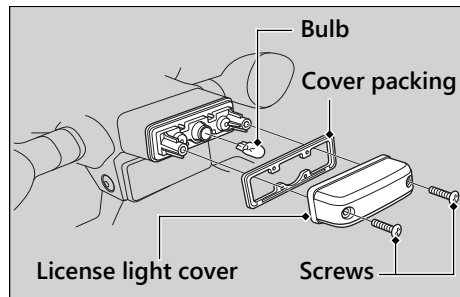

3. Install a new bulb and reinstall the parts in the reverse order of removal.

Blown Fuse

Before handling fuses, see "Inspecting and Replacing Fuses." ► P. 44

Fuse Box Fuses

CBR600RR

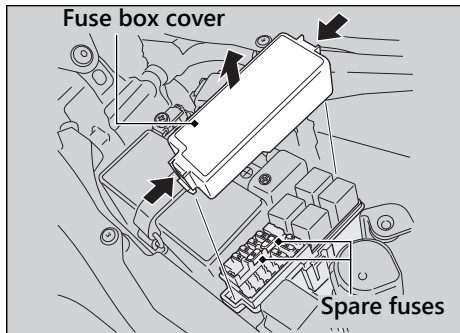

CBR600RA

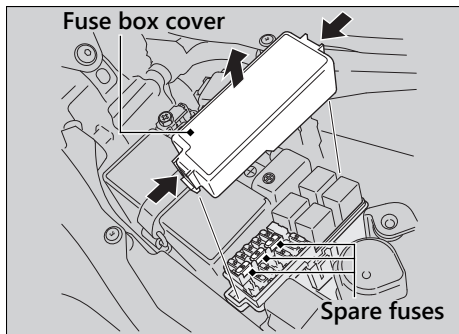

1. Remove the front seat. ► P. 54
2. Remove the fuse box cover.
3. Pull the fuses out one by one with the fuse puller in the tool kit to check for a blown fuse. Always replace a blown fuse with a spare fuse of the same rating.
4. Reinstall the fuse box cover.
5. Reinstall the front seat.

I Main Fuse

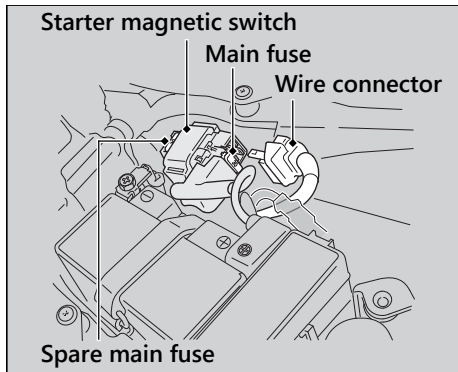

1. Remove the front seat. ► P. 54
2. Disconnect the wire connector of the starter magnetic switch.

3. Pull the main fuse out and check for a blown fuse. Always replace a blown fuse with a spare of the same rating.
 - Spare main fuse is provided in the starter magnetic switch.
4. Reinstall parts in the reverse order of removal.

NOTICE

If a fuse fails repeatedly, you likely have an electrical problem. Have your vehicle inspected by your dealer.

Information

Keys.....	P. 91
Instruments, Controls, & Other Features.....	P. 91
Caring for Your Vehicle.....	P. 93
Storing Your Vehicle.....	P. 96
Transporting Your Vehicle	P. 97
You & the Environment.....	P. 98
Vehicle Identification Number	P. 99
Emission Control Systems	P. 100
Catalytic Converter	P. 105
Oxygenated Fuels.....	P. 106
Authorized Manuals	P. 107
Warranty Coverage and Service	P. 108
Honda Contacts.....	P. 111
Reporting Safety Defects	P. 113

Keys

Ignition Key

Be sure to record the key number provided with the key number plate. Store the spare key and key number in a safe location.

To make a duplicate, take the spare key or the key number to your dealer.

If you lose all ignition keys and the key number, the ignition switch assembly will probably have to be removed by your dealer to determine the key number.

A metal key holder may cause damage to the area surrounding the ignition switch.

Instruments, Controls, & Other Features

Ignition Switch

Leaving the ignition switch in the ON position with the engine stopped will drain the battery. Do not turn the key while riding.

Engine Stop Switch

Do not use the engine stop switch except in an emergency. Doing so when riding will cause the engine to suddenly turn off, making riding unsafe.

If you stop the engine using the engine stop switch, turn the ignition switch to the OFF position. Failing to do so will drain the battery.

Odometer

The display remains at 999,999 when the odometer exceeds 999,999.

Tripmeter

Each tripmeter resets to 0.0 when the trip mileage exceeds 999.9.

Document Bag

The owner's manual, registration, and insurance information can be stored in the plastic document bag located under the rear seat.

Ignition Cut-off System

A banking (lean angle) sensor automatically stops the engine and fuel pump if the vehicle falls over. To reset the sensor, you must turn the ignition switch to the OFF position and back to the ON position before the engine can be restarted.

HESD

The Honda Electronic Steering Damper (HESD) automatically controls the steering damper characteristics in accordance with vehicle speed and acceleration.

HESD Indicator Comes On  P. 82

Caring for Your Vehicle

Frequent cleaning and polishing is important to ensure the life of your Honda. A clean vehicle makes it easier to spot potential problems. In particular, seawater and salts used to prevent ice on roads promote the formation of corrosion. Also, mud and dust may accelerate front fork wear and cause oil leaks. Always wash your vehicle thoroughly after riding on coastal, treated roads and muddy and dusty roads.

Washing

Allow the engine, muffler, brakes, and other high-temperature parts to cool before washing.

1. Rinse your vehicle thoroughly using a low pressure garden hose to remove loose dirt.
2. If necessary, use a sponge or a soft towel with mild cleaner to remove road grime.
 - ▶ Clean the windscreen, headlight lens, panels, and other plastic components with extra care to avoid scratching them.

Avoid directing water into the air cleaner, muffler, and electrical parts.

3. Thoroughly rinse your vehicle with plenty of clean water and dry with a soft, clean cloth.
4. After the vehicle dries, lubricate any moving parts.
 - ▶ Make sure that no lubricant spills onto the brakes or tires. Brake discs, pads, drum or shoes contaminated with oil will suffer greatly reduced braking effectiveness and can lead to a crash.
5. Lubricate the drive chain immediately after washing and drying the vehicle.
6. Apply a coat of wax to prevent corrosion.
 - ▶ Avoid products that contain harsh detergents or chemical solvents. These can damage the metal, paint, and plastic on your vehicle. Keep the wax clear of the tires and brakes.
 - ▶ If your vehicle has any matte painted parts, do not apply a coat of wax to the matte painted surface.

Washing Precautions

Follow these guidelines when washing:

- Do not use high-pressure washers:
 - ▶ High-pressure water cleaners can damage moving parts and electrical parts, rendering them inoperable.
 - ▶ Water in the air intake can be drawn into the throttle body and/or enter the air cleaner.
- Do not direct water at the muffler:
 - ▶ Water in the muffler can prevent starting and causes rust in the muffler.
- Dry the brakes:
 - ▶ Water adversely affects braking effectiveness. After washing, apply the brakes intermittently at low speed to help dry them.
- Do not direct water under the seat:
 - ▶ Water in the under seat compartment can damage your documents and other belongings.
- Do not direct water at the air cleaner:
 - ▶ Water in the air cleaner can prevent the engine from starting.

- Do not direct water near the headlight:
 - ▶ The headlight's inside lens may fog temporarily after washing or while riding in the rain. This does not impact the headlight function.
 - ▶ Any condensation inside the headlight should dissipate after a few minutes of running the engine with the headlight(s) on.
However, if you see a large amount of water or ice accumulated inside the lens(es), have your vehicle inspected by your dealer.
- Do not use wax or polishing compounds on matte painted surfaces:
 - ▶ Use a soft cloth or sponge, plenty of water, and a mild detergent to clean matte painted surfaces. Dry with a soft clean cloth.

Aluminum Components

Aluminum will corrode from contact with dirt, mud, or road salt. Clean aluminum parts regularly and follow these guidelines to avoid scratches:

- Do not use stiff brushes, steel wool, or cleaners containing abrasives.
- Avoid riding over or scraping against curbs.

Panels

Follow these guidelines to prevent scratches and blemishes:

- Wash gently using a soft sponge and plenty of water.
- To remove stubborn stains, use diluted detergent and rinse thoroughly with plenty of water.
- Avoid getting gasoline, brake fluid, or detergents on the instruments, panels, or headlight.

Windscreen

Using plenty of water, clean the windscreen with a soft cloth or sponge. (Avoid using detergents or any kind of chemical cleaner on the windscreen.) Dry with a soft, clean cloth.

NOTICE

To avoid possible scratching or other damage, use only water and a soft cloth or sponge to clean the windscreen.

For a dirtier windscreen, use a diluted neutral detergent with a sponge and plenty of water. Make sure to wash off all the detergent. (Detergent residue may cause windscreen cracks.)

Replace the windscreen if scratches cannot be removed and they obstruct clear vision.

Take care to keep battery electrolyte, brake fluid, or other chemical solvents off the windscreen and screen garnish. They will damage the plastic.

Storing Your Vehicle

Exhaust Pipe and Muffler

The exhaust pipe and muffler are stainless steel but may become stained by mud or dust.

To remove mud or dust, use a wet sponge and a liquid kitchen abrasive, then rinse well with clean water. Dry with chamois or a soft towel.

If necessary, remove heat stains by using a commercially available fine texture compound. Then, rinse by the same manner as removing mud or dust.

NOTICE

Even though the exhaust is made of stainless steel, it can become stained. Remove all marks and blemishes as soon as they are noticed.

Front fork

Mud and dust may accelerate wear on the front forks and cause oil leaks. To avoid scratching, please handle the forks with the following care.

- Wash gently using a soft sponge and plenty of water.
- To remove stubborn stains, use diluted detergent and rinse thoroughly with plenty of water.

Storing Your Vehicle

If you store your vehicle outdoors, you should consider using a full-body cover.

If you won't be riding for an extended period, follow these guidelines:

- Wash your vehicle and wax all painted surfaces (except matte painted surfaces). Coat chrome pieces with rust-inhibiting oil.
- Lubricate the drive chain. ➤ P. 46
- Place your vehicle on a maintenance stand and position a block so that both tires are off the ground.
- After rain, remove the body cover and allow the vehicle to dry.
- Remove the battery (➤ P. 52) to prevent discharge. Fully charge the battery and then place it in a shaded, well-ventilated area.
 - ▶ If you leave the battery in place, disconnect the negative ⊖ terminal to prevent discharge.

After removing your vehicle from storage, inspect all maintenance items required by the Maintenance Schedule.

For more information about storage, refer to the *Honda Winter Storage Guide*, available from your dealer.

Transporting Your Vehicle

If your vehicle needs to be transported, it should be carried on a motorcycle trailer or a flatbed truck or trailer that has a loading ramp or lifting platform and motorcycle tie-down straps. Never try to tow your vehicle with a wheel or wheels on the ground.

NOTICE

Towing your vehicle with a wheel or wheels on the ground can cause serious damage to the transmission.

You & the Environment

Owning and riding a vehicle can be enjoyable, but you must do your part to protect the environment.

Choose Sensible Cleaners

Use a biodegradable detergent when you wash your vehicle. Avoid aerosol spray cleaners that contain chlorofluorocarbons (CFCs) which damage the atmosphere's protective ozone layer.

Recycle Wastes

Put oil and other toxic wastes in approved containers and take them to a recycling center. Call your local or state office of public works or environmental services to find a recycling center in your area and to get instructions on how to dispose of non-recyclable wastes. Do not place used engine oil in the trash or pour it down a drain or on the ground. Used oil, gasoline, coolant, and cleaning solvents contain poisons that can hurt refuse workers and contaminate drinking water, lakes, rivers, and oceans.

Vehicle Identification Number

The VIN and engine serial number uniquely identify your vehicle and are required in order to register your vehicle. They may also be required when ordering replacement parts. You should record these numbers and keep them in a safe place.

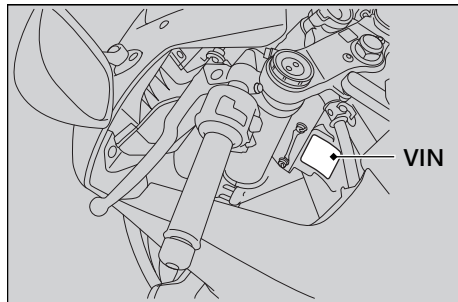
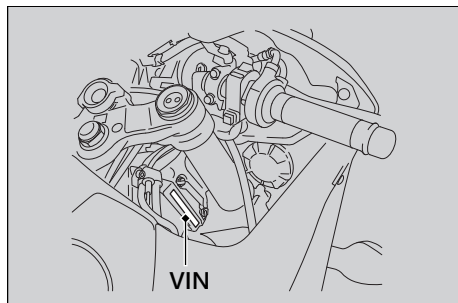

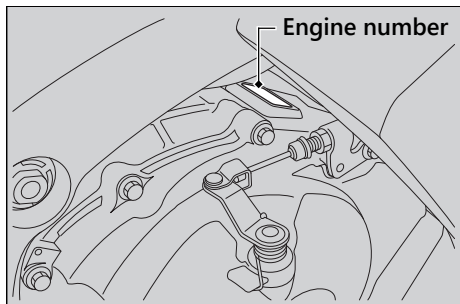

Emission Control Systems

Your vehicle engine emits combustion byproducts, including carbon monoxide (CO), oxides of nitrogen (NO_x), and hydrocarbons (HC). Gasoline evaporation also emits hydrocarbons. Controlling the production of NO_x, CO, and HC is important for the environment.

Exhaust Emission Requirements

The U.S. Environmental Protection Agency (EPA) and the California Air Resources Board (CARB) require that your vehicle comply with applicable exhaust, crankcase, and fuel permeation emission standards during its useful life, when operated and maintained according to the instructions provided.

CARB also requires that your vehicle comply with applicable evaporative emission requirements during its useful life, when operated and maintained according to the instructions provided.

Compliance with the terms of the Distributor's Warranties for Honda Motorcycle Emission Control Systems is necessary in order to maintain a valid emissions system warranty. The Vehicle Emission Control Information label is attached to the rear fender under the rear seat. ➡ P. 57

Vehicle emission control information label

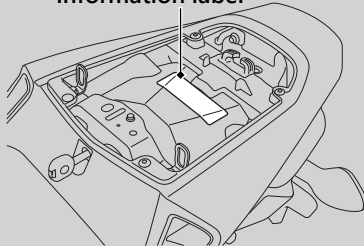

Noise Emission Requirements

The EPA requires that vehicles built after January 1, 1983 comply with applicable noise emission standards for one year or 3,730 miles (6,000 km) after the time of purchase when operated and maintained according to the instructions provided.

Exhaust Emission Control System

The exhaust emission control system includes the following components that should not need adjustment, although periodic inspection by your dealer is recommended.

PGM-FI System

The PGM-FI (programmed fuel injection) system uses sequential multiport fuel injection, and is comprised of air intake, engine control, fuel control, and exhaust control subsystems. The engine control module (ECM) uses sensors to determine how much air enters the engine, and then controls how much fuel to inject.

Ignition Timing Control System

The ignition timing control system adjusts the ignition timing to reduce the amount of HC, CO, and NO_x produced.

Secondary Air Injection System

The secondary air injection system adds filtered air into the exhaust gas to help improve emission control performance.

Catalytic Converters

The exhaust system contains one or more catalytic converters. Catalytic converters use a catalyst to convert most of the harmful exhaust gas compounds into harmless compounds.

Evaporative Emission Control System

50 STATE (meets California)

An evaporative emissions control system uses a canister filled with charcoal to adsorb fuel vapor from the fuel tank while the engine is off. The vapor is drawn into the engine and burned while riding.

Crankcase Emissions Control System

The engine is equipped with a closed crankcase system to prevent discharging crankcase emissions into the atmosphere. Blow-by gas is returned to the combustion chamber through the air cleaner and throttle body.

Fuel Permeation Emission Control

The fuel tank, fuel hoses, and fuel vapor charge hoses use fuel permeation control technologies to prevent fuel vapor emissions. Tampering with these components to reduce or defeat the effectiveness of the fuel permeation technologies is prohibited.

Noise Emission Control System

TAMPERING WITH THE NOISE CONTROL SYSTEM IS PROHIBITED:

U. S. federal law prohibits the following acts or the causing thereof: (1) The removal or rendering inoperative by any person, other than for purposes of maintenance, repair or replacement, of any device or element of design incorporated into any new vehicle for the purpose of noise control prior to its sale or delivery to the ultimate purchaser or while it is in use; or (2) the use of the vehicle after such device or element of design has been removed or rendered inoperative by any person.

AMONG THOSE ACTS PRESUMED TO CONSTITUTE TAMPERING ARE THE FOLLOWING ACTS:

- Removal of, or puncturing the muffler, baffles, header pipes or any other component which conducts exhaust gases.
- Removal of, or puncturing of any part of the intake system.
- Lack of proper maintenance.
- Removing or disabling any emissions compliance component, or replacing any compliance component with a noncompliant component.

Problems Affecting Vehicle Exhaust Emissions

Have your vehicle inspected and repaired by your dealer if you experience any of the following symptoms:

- Hard starting or stalling after starting
- Rough idling
- Misfiring or backfiring during acceleration
- Poor engine performance and poor fuel economy

Catalytic Converter

This vehicle is equipped with a three-way catalytic converter. The catalytic converter contains precious metals that serve as catalysts in high temperature chemical reactions that convert hydrocarbons (HC), carbon monoxide (CO), and oxides of nitrogen (NOx) in the exhaust gases into safe compounds.

A defective catalytic converter contributes to air pollution and can impair your engine's performance. A replacement unit must be an original Honda part or equivalent.

Follow these guidelines to protect your vehicle's catalytic converter:

- Always use unleaded gasoline. Leaded gasoline will damage the catalytic converter.
- Keep the engine in good running condition. A poorly running engine can cause the catalytic converter to overheat, causing damage to the converter or the vehicle.
- If your engine is misfiring, backfiring, stalling, or otherwise not running properly, stop riding and turn off the engine. Have your vehicle serviced as soon as possible.

Oxygenated Fuels

Some conventional fuels blended with alcohol or an ether compound are available in some locales to help reduce emissions to meet clean air standards. These gasolines are collectively referred to as oxygenated fuels. If you plan to use oxygenated fuel, check that it is unleaded and meets the minimum octane rating and blend requirement.

The following fuel blends have been approved for use in your vehicle:

- Ethanol (ethyl alcohol) up to 10% by volume.
 - ▶ Gasoline containing ethanol may be marketed under the name Gasohol.
- Do not use gasoline containing methanol (methyl alcohol).

If you accidentally fill your fuel tank with an oxygenated fuel containing higher percentages, you may experience performance problems. To resolve the problem, have your dealer drain the fuel tank and replace with the correct fuel. Fuel system or performance problems resulting from the use of an oxygenated fuel containing higher percentages are not covered by your warranty.

NOTICE

Improper use of oxygenated fuels can damage metal, rubber, and plastic parts of your fuel system.

Oxygenated fuel can also damage paint.

Damage caused by spilled fuel is not covered by warranty.

If you notice any undesirable operating symptoms or performance problems, try a different brand of gasoline.

Authorized Manuals

The Service Manual used by your authorized dealer is available from your Honda dealer or Helm, Inc.

Also available, but not necessary to service your model, is the Honda Common Service Manual, which explains basic service information for various systems on Honda motorcycles, scooters, ATV, and SxS.

The Winter Storage Guide in conjunction with the Owner's Manual and Service Manual can help you prepare your Honda motorcycle, scooter, ATV, and SxS for winter storage.

These Honda manuals are written for the professional technician. However, if you possess the proper tools, observe the safety standards, and are mechanically capable, you should find them easy to use.

Special Honda tools are necessary for some procedures.

Order online: www.helminc.com

Order Toll Free: 1-888-CYCLE93

(1-888-292-5393)

(NOTE: For Credit Card Orders Only)

Monday - Friday 8:00 AM - 6:00 PM ET

Description
2013-2024 CBR600RR Service Manual
Common Service Manual (61CSM00)
Winter Storage Guide (S9507)
2024 CBR600RR Owner's Manual

Warranty Coverage and Service

Coverage

Your new Honda is covered by the following warranties:

- Vehicle Limited Warranty
- Emission Control System Warranty
- Noise Control Warranty

The responsibilities, restrictions, and exclusions that apply to these warranties are explained in the Warranties Booklet given to you by your Honda dealer at the time of purchase. Always keep your Honda owner's card with your Warranties Booklet.

It is important to realize that your warranty applies only to defects in material or workmanship of your Honda. Your warranty coverage does not apply to the normal wear and deterioration associated with use of the vehicle.

Your warranty coverage is not voided if you perform your own maintenance. However, failures that occur due directly to improper maintenance are not covered by these warranties.

You can extend almost all of your warranty coverage through the HondaCare® Protection Plan. For more information, see your Honda dealer.

Statement on Warranty Coverage for Aftermarket and Recycled Parts

The Magnuson-Moss Warranty Act, 15 U.S.C. s. 2301 et seq., makes it illegal for motor vehicle manufacturers to void a motor vehicle warranty or deny warranty coverage solely because an aftermarket or recycled part has been used to repair the vehicle or someone other than the authorized service provider performed service on the vehicle. This provision does not apply to a new motor vehicle purchased solely for commercial or industrial use.

Under federal law, a manufacturer may deny warranty coverage and charge for repairs to a vehicle if it is discovered that an aftermarket or recycled part installed on the vehicle is defective or was installed incorrectly and caused damage to another part of the vehicle otherwise covered under warranty. The Federal Trade Commission requires that a manufacturer demonstrate that an aftermarket or recycled part or service performed by a person other than an

authorized service provider caused damage to another part of the vehicle otherwise covered under warranty before denying warranty coverage. Additionally, federal law allows a manufacturer to void a motor vehicle warranty or deny warranty coverage if the manufacturer provides the article or service to consumers free of charge under the warranty or the manufacturer has secured a waiver from the Federal Trade Commission.

Warranty Coverage and Service

Service

Please remember that maintenance recommended in the Maintenance Schedule is not included in your warranty coverage.

If you believe you have a problem with your vehicle, call the service department of your Honda dealer. Make an appointment for an inspection and diagnosis. You will be asked to authorize that inspection, and your dealer will return the results of the inspection. If a problem exists and is covered under warranty, your dealer will perform the warranty repairs. If you have any questions about your warranty coverage or the nature of the repair, talk to the Service Manager of your Honda dealer.

If a misunderstanding occurs and you aren't satisfied with your dealer's handling of the situation, we suggest you discuss your problem with the appropriate member of the dealership's management team. If you are still not satisfied, contact the owner of the dealership or their designated representative.

Honda Contacts

American Honda Motor Co., Inc.

If you wish to contact Honda directly to comment on your experiences with your vehicle or with your dealer, please send your comments using one of the following methods:



POST MAIL

Powersports Customer Relations
American Honda Motor Co., Inc.
4900 Marconi Drive
Alpharetta, GA 30005-8847



PHONE

Telephone: (866) 784-1870



ONLINE CUSTOMER SERVICE

Website: <https://powersports.honda.com/contact-us>

Please include the following information in your letter:

- Name, address, and telephone number
- Product model, year, and VIN
- Date of purchase
- Dealer name and address

We will likely ask your Honda dealer to respond, or possibly acknowledge your comments directly.

Your Honda Dealer

The service department of your Honda dealer offers trained personnel to perform regular maintenance and unexpected repairs. It has the latest available service information from Honda and also handles warranty inspections and repairs.

The parts department offers Honda Genuine Parts, Pro Honda products and Honda Accessories that provide the same quality that went into your vehicle.

The sales department offers the HondaCare® Protection Plan to extend almost all of your warranty coverage.

Your Honda dealer can also supply information about riding events and information about safety training available in your local area.

Reporting Safety Defects

If you believe that your vehicle has a defect which could cause a crash or could cause injury or death, you should immediately inform the National Highway Traffic Safety Administration (NHTSA) in addition to notifying American Honda Motor Co., Inc.

If NHTSA receives similar complaints, it may open an investigation, and if it finds that a safety defect exists in a group of vehicles, it may order a recall and remedy campaign. However, NHTSA cannot become involved in individual problems between you, your

dealer, or American Honda Motor Co., Inc.

To contact NHTSA, you may call the Vehicle Safety Hotline toll-free at:

1-888-327-4236

(TTY: 1-800-424-9153); go to

<https://www.safercar.gov>;

or write to:

Administrator, NHTSA,
1200 New Jersey Avenue, SE.,
Washington, DC 20590.

You can also obtain other information about motor vehicle safety from:

<https://www.safercar.gov>.

Specifications

■ Main Components

Overall length	79.9 in (2,030 mm)
Overall width	27.0 in (685 mm)
Overall height	43.9 in (1,115 mm)
Wheelbase	53.9 in (1,370 mm)
Minimum ground clearance	5.3 in (135 mm)
Caster angle	23° 55'
Trail	3.9 in (98 mm)
	CBR600RR
	50 STATE (meets California)
	412 lb (187 kg)
Curb weight	49 STATE 410 lb (186 kg)
	CBR600RA
	50 STATE (meets California)
	434 lb (197 kg)
Maximum weight capacity *1	366 lb (166 kg)
Maximum luggage weight *2	66 lb (30 kg)
	Luggage 31 lb (14 kg)
	Accessories 35 lb (16 kg)
Passenger capacity	Rider and 1 passenger
Minimum turning radius	10.6 ft (3.2 m)
Displacement	36.5 cu-in (599 cm ³)
Bore x stroke	2.64 x 1.67 in (67.0 x 42.5 mm)

Compression ratio	12.2:1
Fuel	Unleaded gasoline Recommended: 91 PON or higher
Tank capacity	4.76 US gal (18.0 L)
Battery	YTZ10S 12 V-8.6 Ah (10 HR)
	1st 2.750
	2nd 2.000
Gear ratio	3rd 1.666
	4th 1.444
	5th 1.304
	6th 1.208
Reduction ratio (primary / final)	2.111 / 2.625

*1: Including rider, passenger, all luggage, and accessories.

*2: Includes the weight of the luggage and added accessories.

■ Service Data

Tire size	Front	120/70ZR17M/C (58W)
	Rear	180/55ZR17M/C (73W)
Tire type	Radial, tubeless	
Recommended Tire	Front	DUNLOP D214F K
	Rear	DUNLOP D214 K
Tire air pressure	Front	36 psi (250 kPa, 2.50 kgf/cm ²)
	Rear	42 psi (290 kPa, 2.90 kgf/cm ²)
Minimum tread depth	Front	0.06 in (1.5 mm)
	Rear	0.08 in (2.0 mm)
Spark plug	(standard)	VUH27D (DENSO)
Spark plug gap	(non-adjustable)	0.03 - 0.04 in (0.8 - 0.9 mm)
Idle speed	(non-adjustable)	1,400 ± 100 rpm
Recommended engine oil	API Service Classification SJ or higher except oils labeled as energy conserving or resource conserving on the circular API service label, SAE 10W-30, JASO T 903 standard MA, Pro Honda GN4 4-stroke oil or Honda 4-stroke oil, or an equivalent motorcycle oil	

Engine oil capacity	After draining	2.9 US qt (2.7 L)
	After draining & engine oil filter change	3.0 US qt (2.8 L)
	After disassembly	3.7 US qt (3.5 L)
Recommended brake fluid	Honda DOT 4 Brake Fluid	
Cooling system capacity	2.99 US qt (2.83 L)	
Recommended coolant	Pro Honda HP Coolant	
Recommended drive chain lubricant	Pro Honda HP Chain Lube or equivalent lubricant	
Drive chain slack	1 3/16 - 1 9/16 in (30 - 40 mm)	
Standard drive chain	DID525HV or RK525ROZ6	
	No. of links	112
Standard sprocket size	Drive sprocket	16T
	Driven sprocket	42T

Specifications

■ Bulbs

Headlight	12 V-55 W × 2
Brake light/Taillight	LED
Front turn signal/Position light	12 V-21/5 W × 2
Rear turn signal	12 V-21 W × 2
License plate light	12 V-5 W

■ Fuses

Main fuse	30 A
Other fuse	CBR600RR 20 A, 10 A
	CBR600RA 30 A, 20 A, 10 A

Information Record

VIN	
Engine No.	
Color Label & Code	
Owner's Name	
Address	
City/State	
Phone	
Dealer's Name	
Address	
City/State	
Phone	
Service Manager	

California Proposition 65 Warning

 **WARNING:** Operating, servicing and maintaining a passenger vehicle or off-highway motor vehicle can expose you to chemicals including engine exhaust, carbon monoxide, phthalates, and lead, which are known to the State of California to cause cancer and birth defects or other reproductive harm. To minimize exposure, avoid breathing exhaust, do not idle the engine except as necessary, service your vehicle in a well-ventilated area and wear gloves or wash your hands frequently when servicing your vehicle. For more information go to www.P65Warnings.ca.gov/passenger-vehicle.



31MJC710
00X31-MJC-7100

© 2023 Honda Motor Co., Ltd.
All Rights Reserved

Printed in the U.S.A.