

2022

Owner's Manual

PCX150/A

**PCX**



This manual should be considered a permanent part of the vehicle and should remain with the vehicle when it is resold.

This publication includes the latest production information available before printing. Honda Motor Co., Ltd. reserves the right to make changes at any time without notice and without incurring any obligation.

No part of this publication may be reproduced without written permission.

The vehicle pictured in this owner's manual may not match your actual vehicle.

# Welcome

Congratulations on your purchase of a new Honda vehicle. Your selection of a Honda makes you part of a worldwide family of satisfied customers who appreciate Honda's reputation for building quality into every product.

To ensure your safety and riding pleasure:

- Read this owner's manual carefully.
- Follow all recommendations and procedures contained in this manual.
- Pay close attention to safety messages contained in this manual and on the vehicle.

To protect your investment, we urge you to take responsibility for keeping your vehicle well-serviced and maintained. Also, observe the break-in guidelines and always perform the pre-ride inspection and other periodic checks in this manual.

When service is required, remember that your Honda dealer knows your vehicle best. If you have the required mechanical “know-how” and tools, you can purchase an official Honda Service Manual to help you perform many maintenance and repair tasks. ➔ P. 118

Read the warranty information thoroughly so that you understand the warranty coverage and are aware of your rights and responsibilities. ➔ P. 119

You may also want to visit our website at [www.powersports.honda.com](http://www.powersports.honda.com).  
Happy riding!

## A Few Words About Safety

Your safety, and the safety of others, is very important. Operating this vehicle safely is an important responsibility.

To help you make informed decisions about safety, we have provided operating procedures and other information on safety labels and in this manual. This information alerts you to potential hazards that could hurt you or others.

Of course, it is not practical or possible to warn you about all hazards associated with operating or maintaining a vehicle. You must use your own good judgment.

You will find important safety information in a variety of forms, including:

- Safety labels on the vehicle
- Safety Messages preceded by a safety alert symbol  and one of three signal words: DANGER, WARNING, or CAUTION. These signal words mean:

### **DANGER**

You **WILL** be **KILLED** or **SERIOUSLY HURT** if you don't follow instructions.

### **WARNING**

You **CAN** be **KILLED** or **SERIOUSLY HURT** if you don't follow instructions.

### **CAUTION**

You **CAN** be **HURT** if you don't follow instructions.

**Other important information is provided under the following titles:**

#### **NOTICE**

Information to help you avoid damage to your vehicle, other property, or the environment.

# Contents

**Vehicle Safety** P. 2

**Operation Guide** P. 18

**Maintenance** P. 56

**Troubleshooting** P. 89

**Information** P. 101

**Specifications** P. 125

# Vehicle Safety

This section contains important information for safe riding of your vehicle.  
Please read this section carefully.

<b>Safety Guidelines</b> .....	P. 3
<b>Safety Labels</b> .....	P. 7
<b>Safety Precautions</b> .....	P. 9
<b>Riding Precautions</b> .....	P. 10
<b>Accessories &amp; Modifications</b> .....	P. 15
<b>Loading</b> .....	P. 16

## Safety Guidelines

Follow these guidelines to enhance your safety:

- Perform all routine and regular inspections specified in this manual.
- Stop the engine and keep sparks and flames away before filling the fuel tank.
- Do not run the engine in enclosed or partly enclosed areas. Carbon monoxide in exhaust gases is toxic and can kill you.

### Always Wear a Helmet

It's a proven fact: helmets and protective apparel significantly reduce the number and severity of head and other injuries. So always wear an approved helmet and protective apparel. ➤ P. 9

### Before Riding

Make sure that you are physically fit, mentally focused, and free of alcohol and drugs. Check that you and your passenger are both wearing an approved helmet and protective apparel. Instruct your passenger on holding onto the grab rail or your waist, leaning with you in turns, and keeping their feet on the footpegs, even when the vehicle is stopped.

### Take Time to Learn & Practice

Even if you have ridden other vehicles, practice riding in a safe area to become familiar with how this vehicle works and handles, and to become accustomed to the vehicle's size and weight.

## Safety Guidelines

We recommend that all riders take a certified course approved by the Motorcycle Safety Foundation (MSF) or a state approved training course. New riders should start with the basic course, and even experienced riders will find the advanced course beneficial.

For information about the MSF training course nearest you, call the national toll-free number: (800) 446-9227.

Other riding tips can be found in the You and Your Motorcycle Riding Tips booklet that came with your vehicle.

### Ride Defensively

Always pay attention to other vehicles around you, and do not assume that other drivers see you. Be prepared to stop quickly or perform an evasive maneuver.

### Make Yourself Easy to See

Make yourself more visible, especially at night, by wearing bright reflective clothing, positioning yourself so other drivers can see you, signaling before turning or changing lanes, and using your horn when necessary.

### Ride within Your Limits

Never ride beyond your personal abilities or faster than conditions warrant. Fatigue and inattention can impair your ability to use good judgment and ride safely.



### **Don't Drink or Use Drugs and Ride**

Alcohol or drugs and riding don't mix. Even one alcoholic drink can reduce your ability to respond to changing conditions, and your reaction time gets worse with every additional drink. The same is true for drug use. Don't drink or use and ride, and don't let your friends do it either.

### **Keep Your Honda in Safe Condition**

It's important to keep your vehicle properly maintained and in safe riding condition. Inspect your vehicle before every ride and perform all recommended maintenance. Never exceed load limits (➤ P. 16), and do not modify your vehicle or install accessories that would make your vehicle unsafe (➤ P. 15).

### **If You are Involved in a Crash**

Personal safety is your first priority. If you or anyone else has been injured, take time to assess the severity of the injuries and whether it is safe to continue riding. Call for emergency assistance if needed. Also follow applicable laws and regulations if another person or vehicle is involved in the crash.

If you decide to continue riding, first turn the ignition switch to the OFF position, and evaluate the condition of your vehicle. Inspect for fluid leaks, check the tightness of critical nuts and bolts, and check the handlebar, control levers, brakes, and wheels. Ride slowly and cautiously. Your vehicle may have suffered damage that is not immediately apparent. Have your vehicle thoroughly checked at a qualified service facility as soon as possible.

### Carbon Monoxide Hazard

Exhaust contains poisonous carbon monoxide, a colorless, odorless gas. Breathing carbon monoxide can cause loss of consciousness and may lead to death.

If you run the engine in a confined or even partly enclosed area, the air you breathe could contain a dangerous amount of carbon monoxide.

Never run your vehicle inside a garage or other enclosure.

### **WARNING**

Running the engine of your vehicle while in an enclosed or even partially enclosed area can cause a rapid build-up of toxic carbon monoxide gas.

Breathing this colorless, odorless gas can quickly cause unconsciousness and lead to death.

Only run your vehicle's engine when it is located in a well ventilated area outdoors.

## Safety Labels

Safety and information labels on your vehicle provide important safety information and may warn you of potential hazards that could cause

serious injury. Read these labels carefully and don't remove them.

If a label comes off or becomes hard to read, contact your dealer for a replacement.

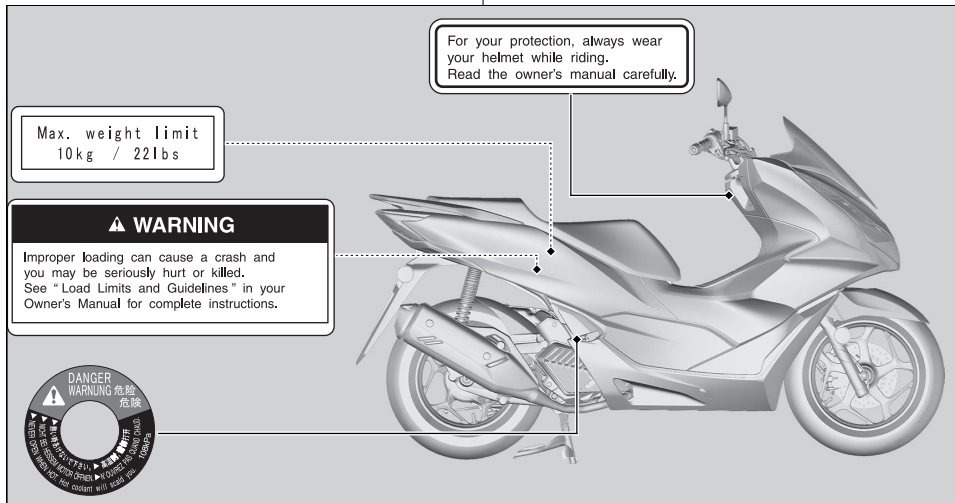

Max. weight limit  
1.0kg / 2.0lbs

## ABS type

**BRAKING INFORMATION**  
This motorcycle is equipped with a front wheel only ABS braking system.  
For detailed braking information, refer to the owner's manual.

TIRE INFORMATION			
Cold tire pressures		kPa	kg/cm <sup>2</sup> psi
Up to maximum weight capacity	Front	200	2.00 29
	Rear	250	2.50 36
Up to 90kg(200lbs) load	Front	200	2.00 29
	Rear	225	2.25 33
Tire size	Front	110/70-14M/C 50P	
	Rear	130/70-13M/C 63P	
Min. recommend tire center tread depth.	Front	1.5mm (0.06in.)	
	Rear	2.0mm (0.08in.)	
Maximum weight capacity	166kg(366lbs)		
Read owner's manual.			

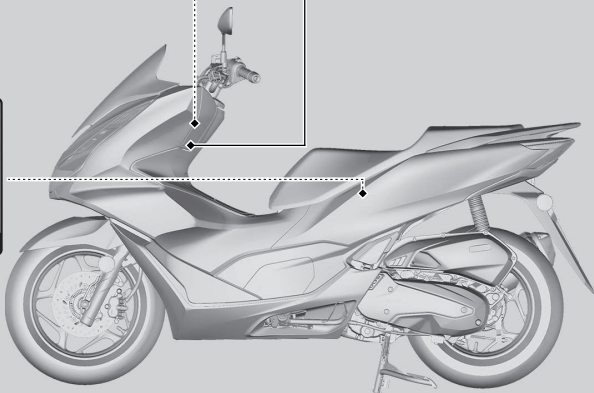

## Safety Precautions

- Ride cautiously and keep your hands on the handlebar and feet on the step board.
- Instruct your passenger to keep their hands on the grab rail or your waist and their feet on the footpegs while riding.
- Always consider the safety of your passenger, as well as other drivers and riders.

### Protective Apparel

Make sure that you and any passenger are wearing an approved helmet, eye protection, and high-visibility protective clothing. Avoid wearing loose clothes that could get caught on any part of the vehicle. Ride defensively in response to weather and road conditions.

### ■ Helmet

Should be safety-standard certified, high-visibility, and the correct size for your head.

- Must fit comfortably but securely, with the chin strap fastened
- Face shield with unobstructed field of vision or other approved eye protection

Look for a DOT (Department of Transportation) certification label on any helmet you buy.

### **WARNING**

Not wearing a helmet increases the chance of serious injury or death in a crash.

Make sure that you and any passenger always wear an approved helmet and protective apparel.

## Riding Precautions

### ■ Gloves

Full-finger leather gloves with high abrasion resistance

### ■ Boots or Riding Shoes

Sturdy boots with non-slip soles and ankle protection

### ■ Jacket and Pants

Protective, highly visible, long-sleeved jacket and durable long pants for riding (or a protective suit)

## Riding Precautions

### Break-in Period

During the first 300 miles (500 km) of running, follow these guidelines to ensure your vehicle's future reliability and performance.

- Avoid full-throttle starts and rapid acceleration.
- Avoid hard braking.
- Ride conservatively.

### Brakes

Observe the following guidelines:

- Avoid excessively hard braking.
  - ▶ Sudden braking can reduce the vehicle's stability.
  - ▶ Where possible, reduce speed before turning; otherwise you risk sliding out.
- Exercise caution on low traction surfaces.
  - ▶ The tires slip more easily on such surfaces and braking distances are longer.

- Avoid continuous braking.
  - ▶ Repeated braking, such as when descending long, steep slopes can seriously overheat the brakes, reducing their effectiveness.
- For full braking effectiveness, operate both the front and rear brakes together.

### ■ Anti-lock Brake System (ABS) on Front Wheel

#### ABS type

This model equipped with an Anti-lock Brake System (ABS) designed to help prevent the front brake from locking up during hard braking.

- There is no ABS function to the rear wheel.
- ABS does not reduce braking distance. In certain circumstances, ABS may result in a longer stopping distance.
- ABS does not function at speeds below 6 mph (10 km/h).
- The front brake lever may recoil slightly when applying the brakes. This is normal.

- Always use the recommended front/rear tires to ensure correct ABS operation.

### ■ Combined Braking System (CBS)

#### Except ABS type

Your vehicle's rear brake system is linked to the front brake. This means that operating the rear brake lever applies the rear brake and a portion of the front brake.

Operating the front brake lever applies only the front brake.

For full braking effectiveness, operate both the front and rear brakes together.

### ■ Wet or Rainy Conditions

Road surfaces are slippery when wet, and wet brakes further reduce braking efficiency.

Exercise extra caution when braking in wet conditions.

If the brakes get wet, apply the brakes while riding at low speed to help them dry.

### Parking

- Park on a firm, level surface.
- If you must park on a slight incline or loose surface, park so that the vehicle cannot move or fall over.
- Make sure that high-temperature parts cannot come into contact with flammable materials.
- Do not touch the engine, muffler, brakes and other high-temperature parts until they cool down.
- To reduce the likelihood of theft, always lock the handlebar and remove the key and close the shutter when leaving the vehicle unattended.  
Use of an anti-theft device is also recommended.

### ■ Parking with the Side Stand or Center Stand

1. Stop the engine.

2. **Using the side stand**

Push the side stand down.

Slowly lean the vehicle to the left until its weight rests on the side stand.

**Using the center stand**

To lower the center stand, stand on the left side of the vehicle.

Hold the left handle grip and the grab rail.

Press down on the tip of the center stand with your right foot and, simultaneously, pull up and back.



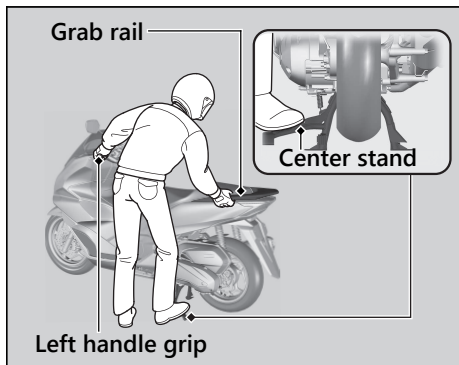

3. Turn the handlebar fully to the left.
  - ▶ Turning the handlebar to the right reduces stability and may cause the vehicle to fall.
4. Turn the ignition switch to the  (Lock) position (➔ P. 38), remove the key and close the shutter (➔ P. 39).

## Refueling and Fuel Guidelines

Follow these guidelines to protect the engine, fuel system and catalytic converter:

- Use only unleaded gasoline.
- Use the recommended octane number. Using lower octane gasoline will result in decreased engine performance.
- Do not use fuels containing a high concentration of alcohol. ➔ P. 117
- Do not use stale or contaminated gasoline or an oil/gasoline mixture.
- Avoid getting dirt or water in the fuel tank.

### **Honda Selectable Torque Control**

#### **ABS type**

When the Honda Selectable Torque Control detects rear wheel spin during acceleration, the system will limit the amount of torque applied to the rear wheel.

Torque Control does not work during deceleration and will not prevent the rear wheel from skidding due to engine braking. Do not close the throttle suddenly, especially when riding on slippery surfaces.

Torque Control may not compensate for rough road conditions or rapid throttle operation. Always consider road and weather conditions, as well as your skills and condition, when applying throttle.

If your vehicle gets stuck in mud, snow, or sand, it may be easier to free it by turning off the Torque Control temporarily.

Temporarily turning off Torque Control also may help you maintain control and balance when riding on off-road terrain.

Always use the recommended tires and the Honda Genuine Parts for drive system such as the drive belt and weight rollers, to ensure correct Torque Control operation.

## Accessories & Modifications

We strongly advise that you do not add any accessories that were not specifically designed or approved for your vehicle by Honda or make modifications to your vehicle from its original design. Doing so can make it unsafe. Modifying your vehicle may also void your warranty and make your vehicle illegal to operate on public roads. Before deciding to install accessories on your vehicle, be certain the modification is safe and legal.

### **WARNING**

Improper accessories or modifications can cause a crash in which you can be seriously hurt or killed.

Follow all instructions in this owner's manual regarding accessories and modifications.

Do not pull a trailer with, or attach a sidecar to, your vehicle. Your vehicle was not designed for these attachments, and their use can seriously impair your vehicle's handling.

## Loading

- Carrying extra weight affects your vehicle's handling, braking and stability. Always ride at a safe speed for the load you are carrying.
- Avoid carrying an excessive load and keep within specified load limits.  
**Maximum weight capacity / Maximum luggage weight** 📖 P. 125
- Tie all luggage securely, evenly balanced, and close to the center of the vehicle.
- Do not place objects near the lights or the muffler.

### **WARNING**

Overloading or improper loading can cause a crash and you can be seriously hurt or killed.

Follow all load limits and other loading guidelines in this manual.

This page intentionally left blank.

# Parts Location

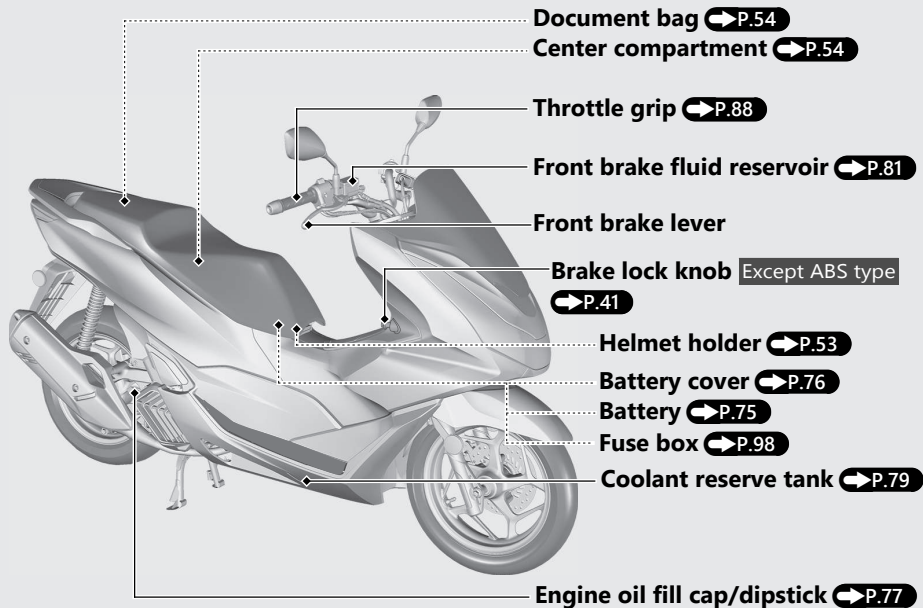

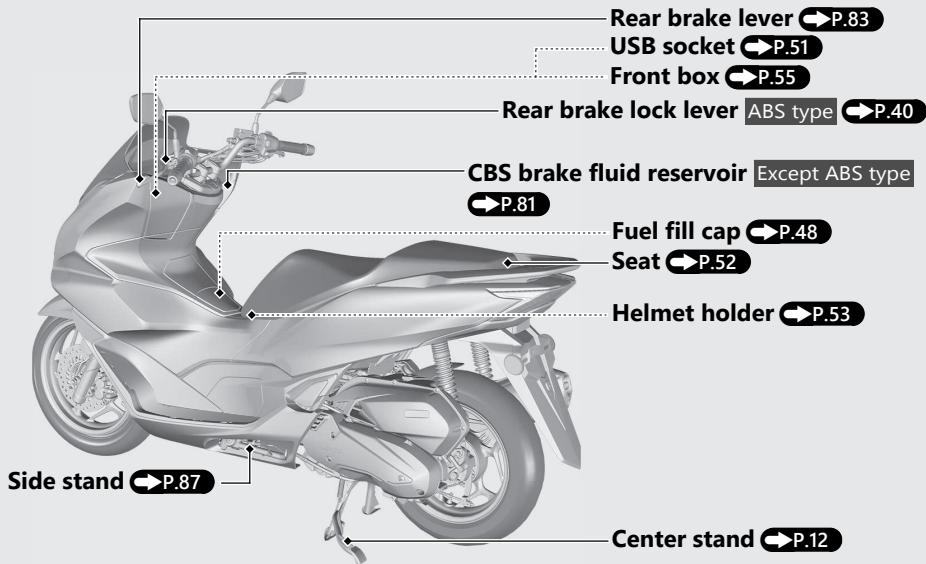

# Instruments

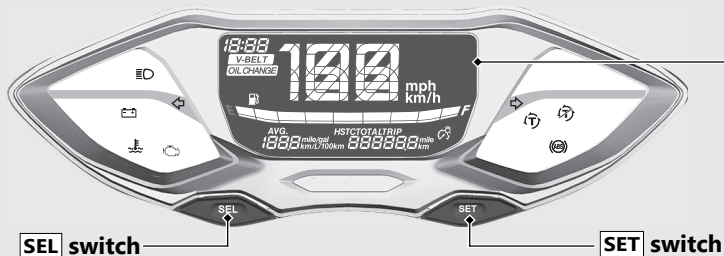

## Display Check

When the ignition switch is turned to the ON position, an initial animation will show. If any part of these displays does not come on when it should, have your dealer check for problems.



**Clock (12-hour display)**To set the clock:  P.26

Speedometer

**Fuel gauge**

Remaining fuel when only 1st (E) segment starts flashing:  
approximately 0.24 US gal (0.9 L)

**If the fuel gauge indicator flashes in a repeat pattern or turns off:**  P.95



## Instruments (Continued)

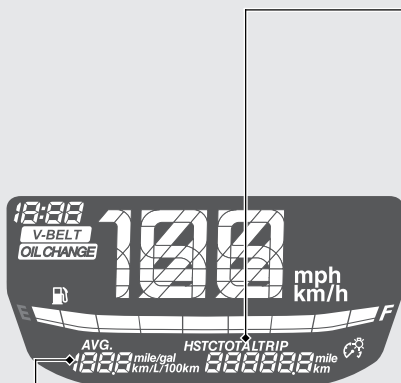

### Average fuel mileage meter [AVG]

The average fuel mileage is based on the tripmeter.  
Average fuel mileage since tripmeter was reset is displayed.  
When " - - - " is displayed except after the average fuel mileage has been reset, go to your dealer for service.

### Odometer [TOTAL], Tripmeter [TRIP], and Torque Control [HSTC]

The **SEL** switch selects the odometer, tripmeter, and Torque Control.

- Odometer:  
Total distance ridden.
- Tripmeter:  
Distance ridden since tripmeter was reset.  
To reset tripmeter, press and hold the **SET** switch with tripmeter displayed.  
The average fuel mileage is also reset.
- **ABS type**  
Torque Control :  
Pressing and holding the **SET** switch while Torque Control is displayed turns Torque Control on and off. **➡ P.42**

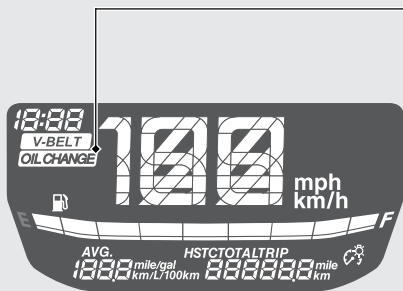

### OIL CHANGE indicator

The indicator turns on when the distance traveled reaches the programmed oil change interval.

When the oil change indicator appears, reset the indicator after changing the engine oil.

- ▶ The indicator does not go off until it is reset.
- ▶ The oil change indicator appears for the first time when the distance traveled reaches 600 miles (1,000 km).
- ▶ After being reset, the oil change indicator comes on again after another 4,000 miles (6,400 km) are ridden.

If the oil is changed before the oil change indicator comes on, be sure to reset the oil change indicator after changing the oil.

**To reset the oil change indicator:** ➡ P.29

You can also check the remaining distance to next interval of the oil change.

**To check the remaining distance:** ➡ P.29

## Instruments *(Continued)*

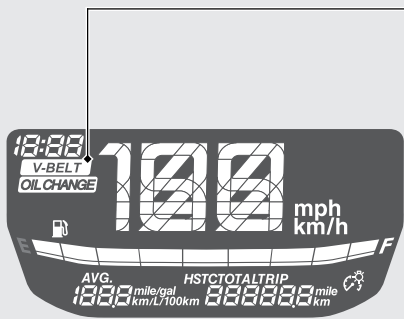

### V-BELT indicator

The indicator turns on when the distance traveled reaches the programmed maintenance interval.

When the V-BELT indicator appears, reset the indicator after performing the periodic maintenance.

- ▶ The indicator does not go off until it is reset.
- ▶ The V-BELT indicator appears for the first time when the distance traveled reaches 8,000 miles (12,000 km).
- ▶ After being reset, the V-BELT indicator comes on again after another 8,000 miles (12,000 km) are ridden.

If the periodic maintenance is performed before the V-BELT indicator comes on, be sure to reset the V-BELT indicator after performing the periodic maintenance.

**To reset the V-BELT indicator:** ➡ P.31

You can also check the remaining distance to next interval of the maintenance.

**To check the remaining distance:** ➡ P.31

## Display Setting

The following items can be changed sequentially.

- Clock setting
- Backlight brightness adjustment
- Changing of speed and mileage unit
- Changing of fuel mileage meter unit
- Resetting OIL CHANGE indicator
- Resetting V-BELT indicator

 Press and hold the **SEL** switch and the **SET** switch

 Press the **SET** switch

 Press the **SEL** switch

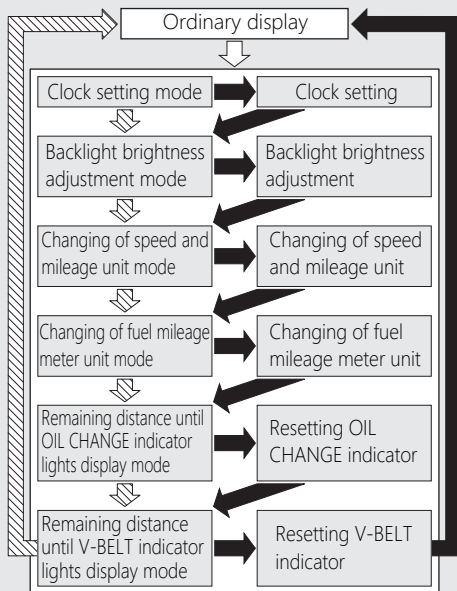

## Instruments *(Continued)*

The following moves the ordinary display at display setting.

- The switch is not pressed for about 30 seconds
  - ▶ The items that are being set are deleted, and only the items whose settings have been completed are reflected.
- Turn the ignition switch to the OFF position and then to the ON position
  - ▶ The items that are being set and the items whose settings have been completed are reflected.

### 1 Clock setting:

- ① Turn the ignition switch to the ON position.
- ② Pressing and holding the **SEL** switch and the **SET** switch makes the hour and minute displays start flashing.
- ③ Press the **SET** switch. The hour digits start flashing.
- ④ Press the **SEL** switch until the desired hour is displayed.
  - ▶ Press and hold to advance the hour fast.



- ⑤ Press the **SET** switch. The minute digits start flashing.



- 6 Press the **SEL** switch until the desired minute is displayed.
- ▶ Press and hold to advance the minute fast.



- 7 Press the **SET** switch. The clock is set, and then the display moves to the backlight brightness adjustment. (Backlight brightness indicator and backlight brightness adjustment segments start flashing.)

## 2 Backlight brightness adjustment:

You can adjust the brightness to one of five levels.

- 1 Press the **SET** switch. The backlight brightness indicator and backlight brightness adjustment segments stop flashing.
- 2 Press the **SEL** switch. The brightness is switched.



- 3 Press the **SET** switch. The backlight is set, and then the display moves to the changing of speed and mileage unit. (Speed and mileage unit start flashing.)

## Instruments *(Continued)*

### 3 Changing of speed and mileage unit:

- 1 Press the **SET** switch. The speed and mileage unit starts flashing fast.
- 2 Press the **SEL** switch to select either "km/h" and "km" or "mph" and "mile".

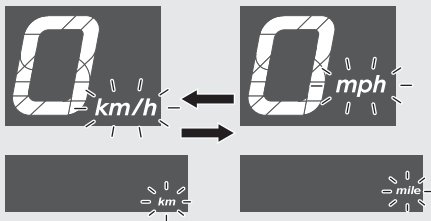

- 3 Press the **SET** switch. The speed and mileage unit is set, and then the display moves to the changing of fuel mileage meter unit. (Fuel mileage meter unit start flashing.)

### 4 Changing the fuel mileage meter unit:

- 1 Press the **SET** switch, the fuel mileage meter unit start flashing fast.
- 2 When the speed and mileage unit selecting "km/h" and "km". Press the **SEL** switch to select "km/L" or "L/100km".



When the speed and mileage unit selecting "mph" and "mile".

The fuel mileage is indicated by "mile/gal".

- 3 Press the **SET** switch. The fuel mileage meter unit is set, and then the display moves to remaining distance until OIL CHANGE indicator lights. (OIL CHANGE indicator starts flashing.)



## 5 Remaining distance until OIL CHANGE indicator lights display:

You can confirm the remaining distance until the OIL CHANGE indicator lights, and then reset the OIL CHANGE indicator.

### Confirming the remaining distance until OIL CHANGE indicator lights

Display the remaining distance until the OIL CHANGE indicator lights.

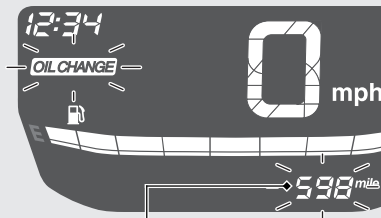

Remaining distance until  
OIL CHANGE indicator lights

### Resetting OIL CHANGE indicator

- 1 Press the **SET** switch. The OIL CHANGE indicator and the remaining distance until the OIL CHANGE indicator lights flash.
  - ▶ "P" flashes when the remaining distance until the OIL CHANGE indicator lights is displayed.

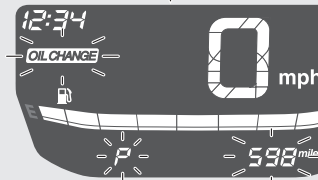
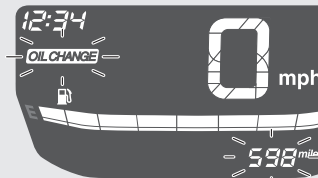

## Instruments *(Continued)*

- 2 Press the **SEL** switch to select oil change interval.
  - ▶ "P" turns off when the oil change interval is displayed.
  - ▶ When the remaining distance until the OIL CHANGE indicator lights is displayed, the OIL CHANGE indicator does not reset even if the **SET** switch is pressed.

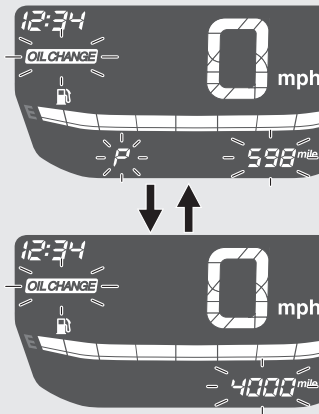

- 3 Press the **SET** switch and set the oil change interval. When this is set, the OIL CHANGE indicator is reset and the display moves to the remaining distance until V-BELT indicator lights. (V-BELT indicator starts flashing.)

## 6 Remaining distance until V-BELT indicator lights display:

You can confirm the remaining distance until the V-BELT indicator lights, and then reset the V-BELT indicator.

### Confirming the remaining distance until V-BELT indicator lights

Display the remaining distance until the V-BELT indicator lights.

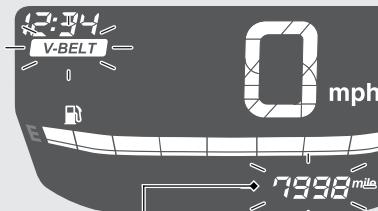

Remaining distance until V-BELT indicator lights

### Resetting V-BELT indicator

- 1 Press the **SET** switch. The V-BELT indicator and the remaining distance until the V-BELT indicator lights flash.
  - ▶ "P" flashes when the remaining distance until V-BELT indicator lights is displayed.

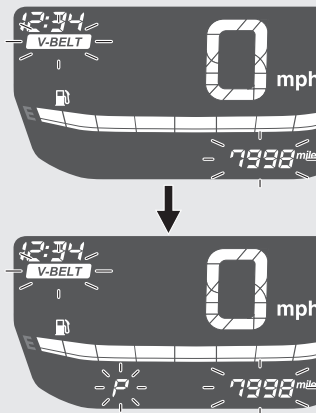

## Instruments *(Continued)*

- Press the **SEL** switch to select maintenance interval.
  - ▶ “P” turns off when the maintenance interval is displayed.
  - ▶ When the remaining distance until the V-BELT indicator lights is displayed, the V-BELT indicator does not reset even if the **SET** switch is pressed.

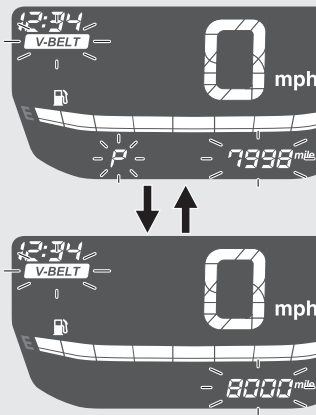



- Press the **SET** switch and set the maintenance interval. When this is set, the V-BELT indicator is reset and the display moves to the normal display.

# Indicators

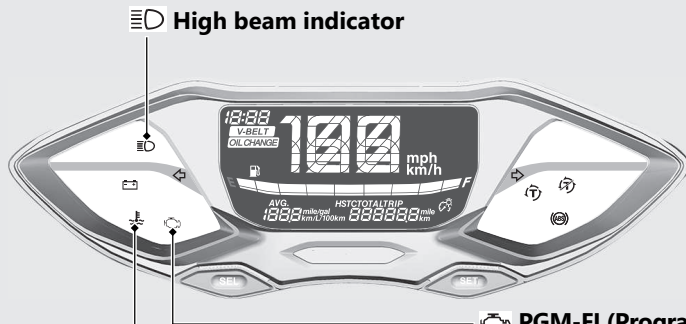
If one of these indicators does not come on when it should, have your dealer check for problems.



 **High beam indicator**

 **High coolant temperature indicator**

**If it comes on while riding:**

 **P.91**

 **PGM-FI (Programmed Fuel Injection) malfunction indicator lamp (MIL)**

Comes on briefly when the ignition switch is turned to the ON position with engine stop switch in the  (Run) position.

**If it comes on while engine is running:**

 **P.92**

## Indicators (Continued)

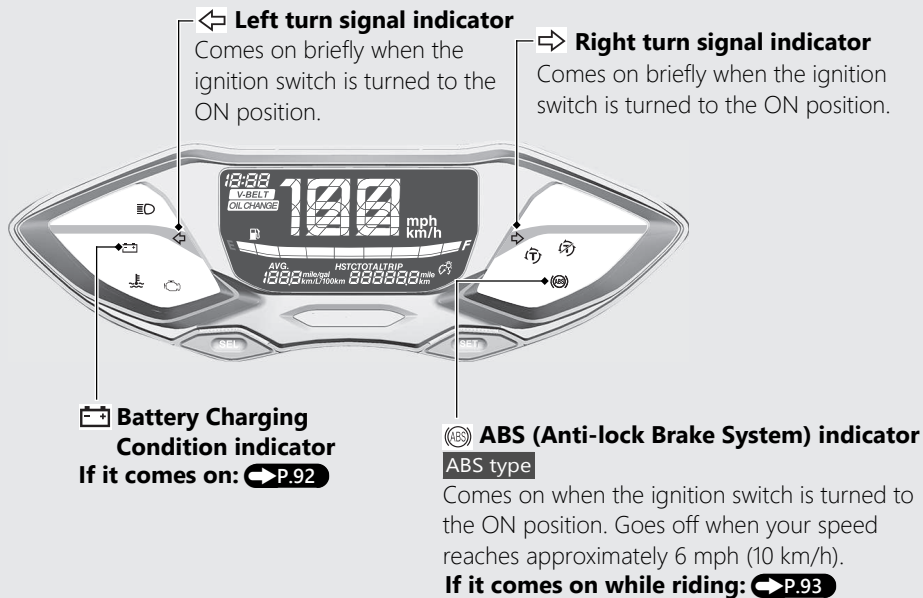

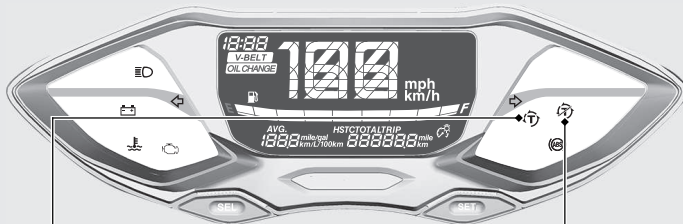

### Torque Control indicator

ABS type

- Comes on when the ignition switch is turned to the ON position.
- Goes off when your speed reaches approximately 2 mph (3 km/h) to indicate Torque Control is ready to work.
- Blinks when Torque Control is operating.

**If it comes on while riding:** ➔ P.94



### Torque Control OFF indicator

ABS type

Comes on when the Torque Control is turned to off.

# Switches

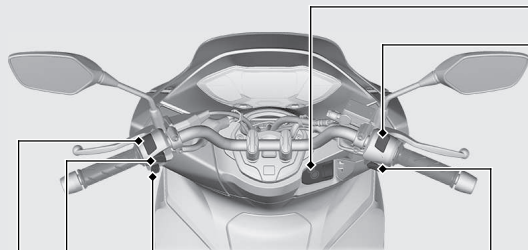



## Turn signal switch

- ▶ Pressing the switch turns the turn signal off.





## Horn button

## Headlight dimmer switch

-  : High beam
-  : Low beam

## Engine stop switch

Should normally remain in the  (Run) position.

- ▶ In an emergency, switch to the  (Stop) position (the starter motor will not operate) to stop the engine.



## Start button



## Ignition switch

Switches the electrical system on/off, locks the steering, and operates the fuel lid and seat opener switch.

► Key can be removed when in the OFF position or  (Lock) position.

### ON

Turns electrical system on for starting/riding.

### SEAT FUEL

Operates the fuel lid and seat opener switch.

### OFF

Turns engine off.

### (Lock)

Locks steering.



## Switches *(Continued)*

### Steering Lock

Lock the steering when parking to help prevent theft.

A U-shaped wheel lock or similar device is also recommended.

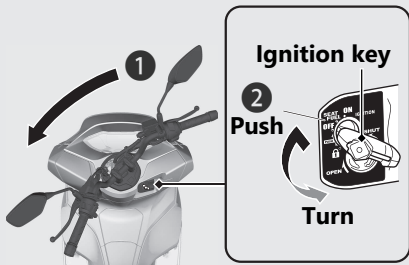

### Locking

- 1 Turn the handlebar all the way to the left or right.
- 2 Push the key down, and turn the ignition switch to the  (Lock) position.
  - ▶ Jiggle the handlebar if the lock is difficult to engage.
- 3 Remove the key.

### Unlocking

Insert the key, push it in, and turn the ignition switch to the OFF position.

## Shutter

The ignition switch for this vehicle is equipped with an automatic shutter. After parking the vehicle, close the shutter for theft prevention.

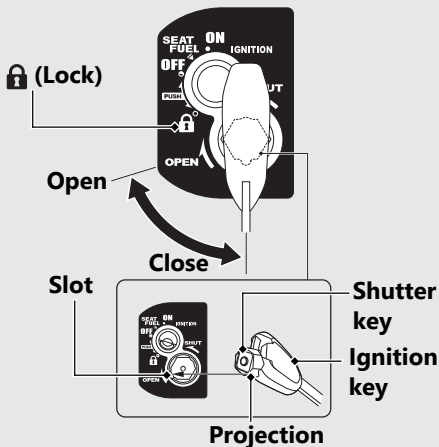

The shutter will automatically close when you remove the ignition key at the  (Lock) position.

Also you can close the shutter manually.

### Close

- 1 Remove the ignition key from the ignition switch.
- 2 Align the projection of the shutter key with the slot of the shutter, and turn the shutter key counterclockwise.
- 3 Remove the key.

### Open

Align the projection of the shutter key with the slot of the shutter, and turn the shutter key clockwise.

# Rear Brake Lock

Be sure the rear brake lock is applied while starting and warming up the engine.

## ABS type

### Locking

Squeeze the rear brake lever and set the rear brake lock lever.

- ▶ The rear brake lock will not function if the rear brake is not adjusted properly.

➔ P.84

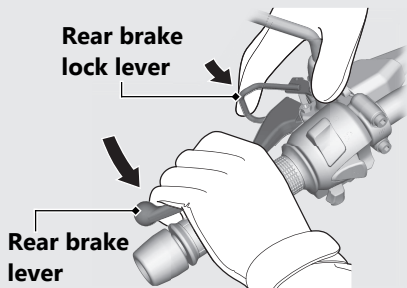

### Unlocking

Squeeze the rear brake lever.

- ▶ Before riding, make sure that the rear brake lock is fully released so there is no drag on the rear wheel.

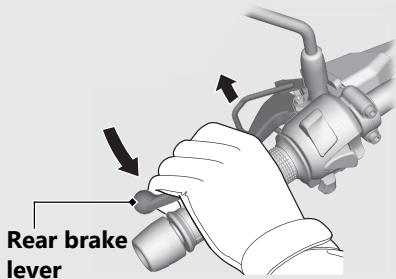

Except ABS type

## Locking

Squeeze the rear brake lever and pull the brake lock knob.

- ▶ The rear brake lock will not function if the rear brake is not adjusted properly.

➡ P.84

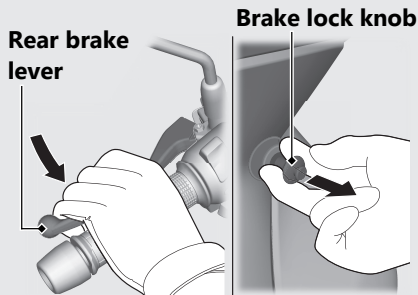

## Unlocking

Squeeze the rear brake lever and press the brake lock knob down while pushing in the center button.

- ▶ Before riding, make sure that the rear brake lock is fully released so there is no drag on the rear wheel.

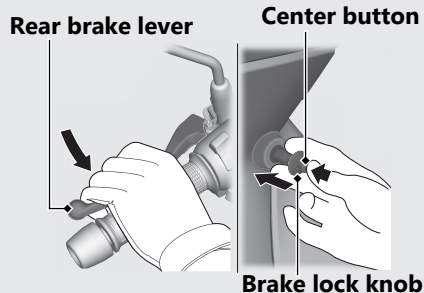

# Honda Selectable Torque Control

## ABS type

Torque Control (engine power control) can be turned on/off.

- ▶ Stop the vehicle first, before turning the Torque Control off or on.
- ▶ The Torque Control cannot be turned off when the system is activated (Torque Control indicator blinking).
- ▶ Each time the ignition switch is turned to the ON position, the Torque Control will automatically be set to on.

## Torque Control OFF indicator

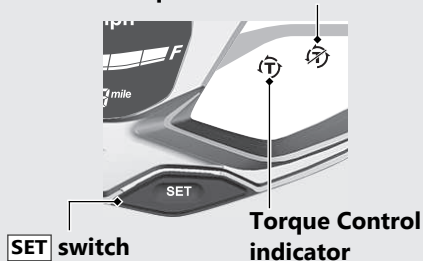

## Torque Control on and off

Press **SEL** switch to display the Torque Control [HSTC]. Pressing and holding **SET** switch while Torque Control [HSTC] is displayed switches between on and off.

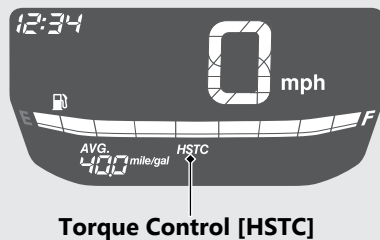

# Starting the Engine

Start your engine using the following procedure, regardless of whether the engine is cold or warm.

This vehicle is equipped with a side stand ignition cut-off system.

- ▶ If the side stand is down, the engine cannot be started.
- ▶ If you lower the side stand with the engine running, it will automatically shut off.

## NOTICE

- If the engine does not start within 5 seconds, turn the ignition switch to the OFF position and wait 10 seconds before trying to start the engine again to recover battery voltage.
- Extended fast idling and revving the engine can damage the engine and the exhaust system.

1 Place the vehicle on its center stand.

2 **ABS type**

Lock the rear wheel by squeezing the rear brake lever and setting the rear brake lock lever.

**Except ABS type**

Lock the rear wheel by squeezing the rear brake lever and setting the brake lock knob.

- ▶ The starter motor will only work when the rear brake lever is squeezed and the side stand is up.

**ABS type**

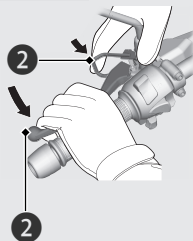

**Except ABS type**

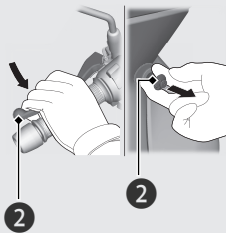

## Starting the Engine *(Continued)*

- 3 Make sure the engine stop switch is in the  (Run) position.
- 4 Turn the ignition switch to the ON position.

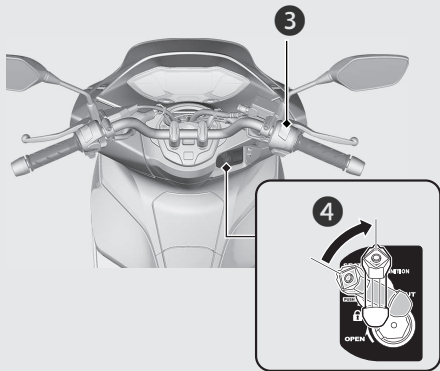

- 5 Press the start button with the throttle completely closed. Release the start button as soon as the engine starts.

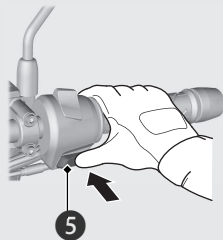



**If you cannot start the engine:**

- ① Place the vehicle on its center stand and squeeze the rear brake lever.
- ② With the throttle slightly open (about 1/8 in [3 mm], without freeplay), press the start button.

**About 1/8 in (3 mm), without freeplay**

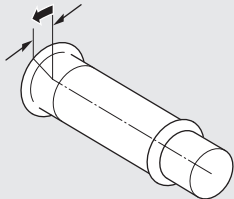
**If the engine does not start:**

- ① Open the throttle fully and press the start button for 5 seconds.
- ② Repeat the normal starting procedure.
- ③ If the engine starts, open the throttle slightly if idling is unstable.
- ④ If the engine does not start, wait 10 seconds before trying steps ① & ② again.

**If Engine Will Not Start** ➔ P.90

# Riding

## Starting the Vehicle

- 1 Push the vehicle forward off the center stand.
  - ▶ Lock the rear brake lock.
  - ▶ Keep throttle closed.

Make sure the side stand and center stand are up.

- 2 Get on the vehicle.
  - ▶ Mount the vehicle from the left side, keeping at least one foot on the ground.
- 3 Release the rear brake lock.

- 4 Acceleration and deceleration  
To accelerate: Open the throttle slowly.  
To decelerate: Close the throttle.

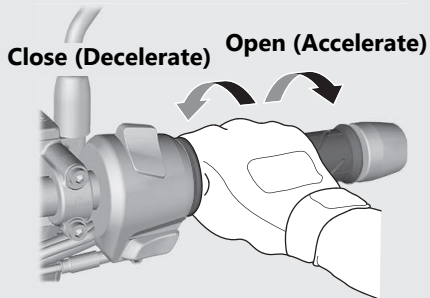

## Braking

Close the throttle and apply the front and rear brake levers together.

Do not apply the brake lock while riding. It may cause the wheel to lock, reducing control of the vehicle.

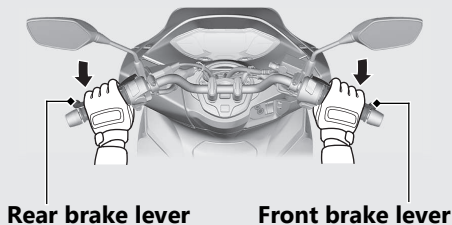

# Refueling

**Fuel type:** Unleaded gasoline only

**Recommended fuel octane number:**  
Pump Octane Number (PON) 86 or higher.

**Tank capacity:** 2.14 US gal (8.1 L)

**Refueling and Fuel Guidelines** ➔ P.13

## Opening the Fuel Fill Cap

- 1 Insert the ignition key and turn it to the position of SEAT FUEL.
- 2 Push the FUEL side of the fuel lid and seat opener switch.
  - ▶ The fuel lid opens.

### Fuel lid

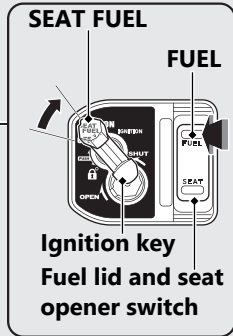
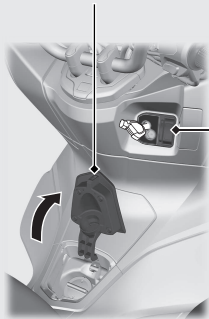

- 3 Turn the fuel fill cap counterclockwise and remove the fuel fill cap.

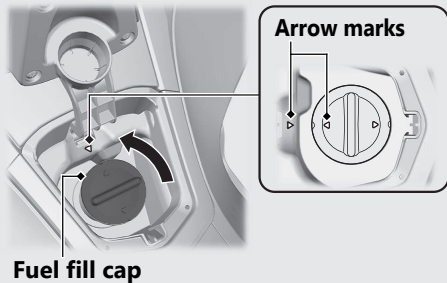

- 4 Put the removed fuel fill cap on the fuel fill cap resting place.

**Fuel fill cap resting place**

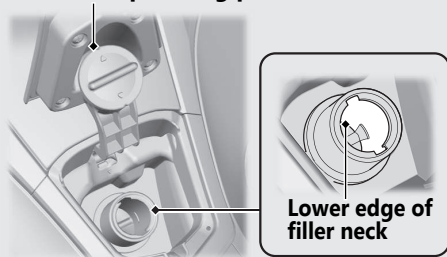

Do not fill with fuel above the lower edge of the filler neck.

## Refueling *(Continued)*

### Closing the Fuel Fill Cap

- ① Install and tighten the fuel fill cap firmly by turning it clockwise.
  - ▶ Make sure that the arrow marks on the fuel fill cap and fuel tank are aligned.
- ② Close the fuel lid until it locks.
  - ▶ Make sure that the fuel lid is closed securely.

### **⚠WARNING**

Gasoline is highly flammable and explosive. You can be burned or seriously injured when handling fuel.

- Stop the engine, and keep heat, sparks, and flames away.
- Only handle fuel outdoors.
- Wipe up spills immediately.

# USB Socket

The USB socket is located in the front box.

➔ P.55

Use USB devices at your own risk. In no event shall Honda be liable for any damage to your USB device when in use.

Open the cover to access the USB socket.

USB type-C connectors can be used.

Rated capacity is

**15 W (5 V, 3.0 A).**

▶ The USB socket is for charging only.

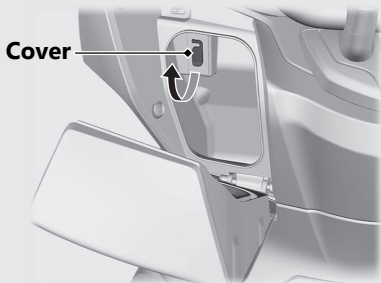

- ▶ To prevent the battery from becoming weak (or dead), keep the engine running while drawing current from the USB socket.
- ▶ To prevent entry of foreign matter into the USB socket, be sure to close the cover when the USB socket is not used.

## NOTICE

- Using any heat-generating USB devices or improperly rated USB devices can damage the USB socket.
- Do not use the USB socket in wet conditions, when or while washing or any other wet conditions as these will damage the USB socket.
- Do not allow the USB's harness to become pinched or trapped.

# Storage Equipment

## Seat

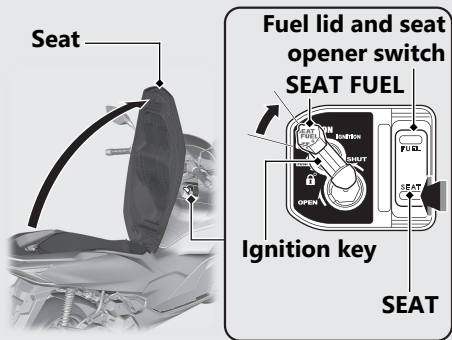

## Seat Open

- 1 Turn the handlebar pointed straight ahead.
- 2 Insert the ignition key and turn it to the position of SEAT FUEL.
- 3 Push the SEAT side of the fuel lid and seat opener switch.
- 4 Open the seat.

## Seat Close

Close and push down on the rear of the seat until it locks. Make sure that the seat is locked securely by pulling it up lightly. Take care not to lock your key in the compartment under the seat.



## Helmet Holder

The helmet holder is located under the seat.

- ▶ Use the helmet holder only when parked.

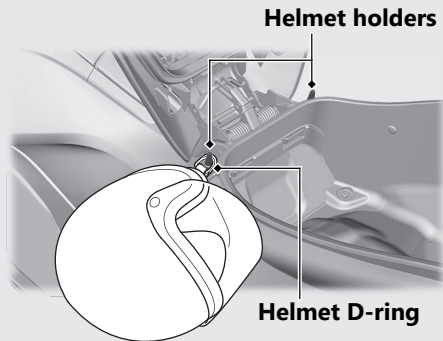

## **⚠**WARNING

Riding with a helmet attached to the holder can interfere with your ability to safely operate the vehicle and could lead to a crash in which you can be seriously hurt or killed.

Use the helmet holder only while parked. Do not ride with a helmet secured by the holder.

## Storage Equipment *(Continued)*

A helmet can be stored in the center compartment.

Set in the front of the helmet forward.

- ▶ Some helmets may not fit in the compartment due to their size or design.

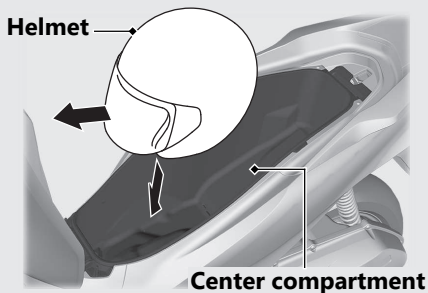

### Center compartment

Never exceed the maximum weight limit.

#### Maximum Weight: 22 lb (10 kg)

- ▶ Do not store any items that are flammable or susceptible to heat damage.
- ▶ Do not store valuables or fragile articles.

## Document Bag

The document bag is located underside of the seat by the rubber straps.

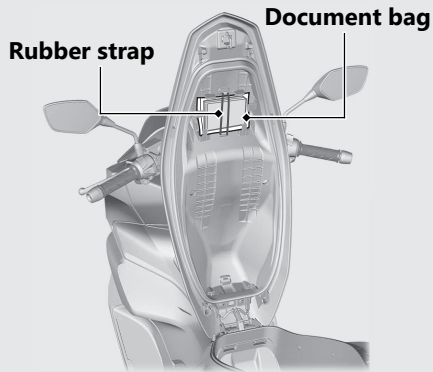

## Front Box

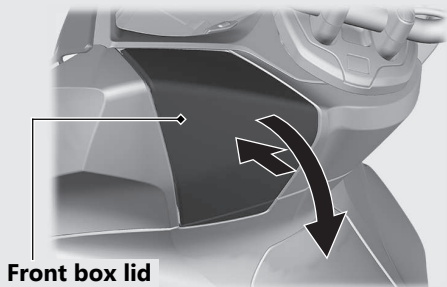

### Open

Push the front box lid, then open the front box lid.

### Close

Close the front box lid by pressing the front box lid.

The maximum allowable load in the front box shall be no more than

**2.0 lb (1.0 kg)**

Make sure that the front box lid is closed securely.

▶ Do not store valuables or fragile articles.

# Maintenance

Please read "Importance of Maintenance" and "Maintenance Fundamentals" carefully before attempting any maintenance. Refer to "Specifications" for service data.

An optional larger tool kit may be available.

Check with your Honda dealer's parts department.

<b>Importance of Maintenance .....</b>	<b>P. 57</b>
<b>Maintenance Schedule.....</b>	<b>P. 59</b>
<b>Maintenance Record.....</b>	<b>P. 62</b>
<b>Maintenance Fundamentals .....</b>	<b>P. 63</b>
<b>Removing &amp; Installing Body Components..</b>	<b>P. 75</b>
Battery .....	P. 75
Battery Cover.....	P. 76
<b>Engine Oil .....</b>	<b>P. 77</b>
<b>Coolant.....</b>	<b>P. 79</b>
<b>Brakes.....</b>	<b>P. 81</b>
<b>Side Stand .....</b>	<b>P. 87</b>
<b>Throttle .....</b>	<b>P. 88</b>

# Importance of Maintenance

## Importance of Maintenance

Keeping your vehicle well-maintained is absolutely essential to your safety and to protect your investment, obtain maximum performance, avoid breakdowns, and reduce air pollution. Maintenance is the owner's responsibility. Be sure to inspect your vehicle before each ride and perform the periodic checks specified in the Maintenance Schedule. ➤ P. 59

### **⚠ WARNING**

Improperly maintaining your vehicle or failing to correct a problem before you ride can cause a crash in which you can be seriously hurt or killed.

Always follow the inspection and maintenance recommendations and schedules in this owner's manual.

For information about the exhaust emission and noise emission requirements of the U.S. Environmental Protection Agency (EPA), and the California Air Resources Board (CARB). ➤ P. 112

**Maintenance, replacement or repair of the emission control devices and systems may be performed by any vehicle repair establishment or individual using parts that are "certified" to EPA standards.**

### Maintenance Safety

Always read the maintenance instructions before you begin each task and make sure that you have the tools, parts, and skills required. We cannot warn you of every conceivable hazard that can arise in performing maintenance. Only you can decide whether or not you should perform a given task.

Follow these guidelines when performing maintenance.

- Stop the engine and remove the key.
- Place your vehicle on a firm, level surface using the side stand, center stand or a maintenance stand to provide support.
- Allow the engine, muffler, brakes, and other high-temperature parts to cool before servicing as you can get burned.
- Run the engine only when instructed, and do so in a well-ventilated area.

## Maintenance Schedule







The maintenance schedule specifies the maintenance requirements necessary to ensure safe, dependable performance, and proper emission control.

Maintenance work should be performed in accordance with Honda's standards and specifications by properly trained and equipped technicians. Your dealer meets all of these requirements. All scheduled maintenance is considered a normal owner operating cost and will be charged to you by your dealer. Keeping an accurate maintenance record will help ensure your vehicle is properly maintained.



➤ P. 62

Make sure whoever performs the scheduled maintenance completes the maintenance record. Retain all service documents. If you sell your vehicle, these service documents should be transferred with the vehicle to the new owner.

# Maintenance Schedule

Items		Frequency*1								Regular Replace	Refer to page	
		× 1,000 mi	0.6	4	8	12	16	20	24			
		× 1,000 km	1.0	6.4	12.8	19.2	25.6	32.0	38.4			
Emission-Related Items	Fuel Line				I	I	I	I	I	I		-
	Throttle Operation				I	I	I	I	I	I		88
	Air Cleaner*2						R			R		-
	Crankcase Breather*3				C	C	C	C	C	C		-
	Spark Plug				I	R	I	R	I	R		-
	Valve Clearance				I	I	I	I	I	I		-
	Engine Oil			R	R	R	R	R	R	R	1 Year	77
	Engine Oil Strainer Screen					C		C		C		-
	Engine Idle Speed				I	I	I	I	I	I		-
	Radiator Coolant*5					I		I		I	3 Years	79
	Cooling System					I		I		I		-
	Evaporative Emission Control System*4						I			I		-





































































## Maintenance Level

-  : Intermediate. We recommend service by your dealer, unless you have the necessary tools and are mechanically skilled. Procedures are provided in an official Honda Service Manual (➤ P. 118).
-  : Technical. In the interest of safety, have your vehicle serviced by your dealer.

## Maintenance Legend

- I** : Inspect (clean, adjust, lubricate, or replace, if necessary)
- R** : Replace
- C** : Clean



Items		Frequency*1								Regular Replace	Refer to page
		× 1,000 mi	0.6	4	8	12	16	20	24		
		× 1,000 km	1.0	6.4	12.8	19.2	25.6	32.0	38.4		
Non-Emission-Related Items	Drive Belt										-
	Final Drive Oil *5									2 Years	-
	Brake Fluid*5									2 Years	81
	Brake Shoes/Pads Wear										82, 86
	Brake System										63
	Brake Lock Operation										40
	Headlight Aim										-
	Clutch Shoes Wear										-
	Side Stand										87
	Suspension										-
	Nuts, Bolts, Fasteners										-
	Wheels/Tires										71
Steering Head Bearings										-	

## Notes:

\*1: At higher odometer reading, repeat at the frequency interval established here.

\*2: Service more frequently when riding in unusually wet or dusty areas.

\*3: Service more frequently when riding in rain or at full throttle.

\*4: 50 STATE (meets California).

\*5: Replacement requires mechanical skill.

# Maintenance Record

<b>Distance</b>	<b>Odometer</b>	<b>Date</b>	<b>Performed By:</b>	<b>Notes</b>
600 miles (1,000 km)				
4,000 miles (6,400 km)				
8,000 miles (12,800 km)				
12,000 miles (19,200 km)				
16,000 miles (25,600 km)				
20,000 miles (32,000 km)				
24,000 miles (38,400 km)				
28,000 miles (44,800 km)				
32,000 miles (51,200 km)				
36,000 miles (57,600 km)				
40,000 miles (64,000 km)				
44,000 miles (70,400 km)				
48,000 miles (76,800 km)				
52,000 miles (83,200 km)				
56,000 miles (89,600 km)				
60,000 miles (96,000 km)				
64,000 miles (102,400 km)				
68,000 miles (108,800 km)				

## Pre-ride Inspection

To ensure safety, it is your responsibility to perform a pre-ride inspection and make sure that any problem you find is corrected. A pre-ride inspection is a must, not only for safety, but because having a breakdown, or even a flat tire, can be a major inconvenience.

Check the following items before you get on your vehicle:

- Tire tread wear and air pressures are within limits ➤ P. 71
- Lights, horn, and turn signals operate normally

Check the following items if you are carrying a passenger or cargo:

- Combined weight is within load limits ➤ P. 125
- Cargo is secured properly

Check the following items after you get on your vehicle:

- Throttle action moves smoothly without binding ➤ P. 88
- Brake levers operate normally
- Check the fuel level and refuel when needed ➤ P. 13, ➤ P. 48
- Engine stop switch functions properly ➤ P. 36

Check the following items at regular intervals:

- Oil level is between the upper and lower level marks ➤ P. 77
- **ABS type**  
Brake fluid level is above the LWR level mark ➤ P. 81
- **Except ABS type**  
Brake fluid level is  
Front: above the LWR level mark ➤ P. 81  
Combi Brake: between the UPPER and LOWER level marks ➤ P. 81
- Engine coolant level is between the UPPER and LOWER level marks ➤ P. 79
- Side stand functions properly ➤ P. 87
- Rear brake lock works properly ➤ P. 40

### Periodic Checks

You should also perform other periodic maintenance checks at least once a month regardless of how often you ride, or more often if you ride frequently.

Also, check the odometer reading against the Maintenance Schedule and perform all maintenance that is due. ➔ P. 59

Tires and wheels	Check the air pressure (➔ P. 71), examine tread for wear and damage (➔ P. 71), and check the wheels for damage.
Fluid levels	Check the engine oil level (➔ P. 77), engine coolant level (➔ P. 79), and brake fluid level (➔ P. 81).
Lights	Check that the headlight, position lights, brake light, taillight, turn signals, and license plate light are working properly.
Controls	Check the freeplay of the rear brake lever (➔ P. 83), throttle grip (➔ P. 88) and rear brake lock (➔ P. 40) operate properly.
Fuses	Check that you have a full supply of spare fuses.
Nuts & bolts	Check the major nuts and bolts, and tighten as needed.

## Replacing Parts

Always use Honda Genuine Parts or their equivalents to ensure reliability and safety. When ordering colored components, specify the model name, color, and code mentioned on the color label.

The color label is attached to the center compartment. ➤ P. 54

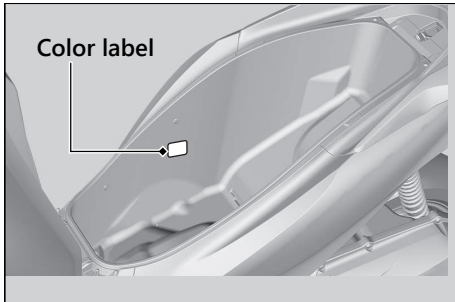

## **⚠**WARNING

Installing non-Honda parts may make your vehicle unsafe and cause a crash in which you can be seriously hurt or killed.

Always use Honda Genuine Parts or equivalents that have been designed and approved for your vehicle.

### Battery

Your vehicle has a maintenance-free type battery. You do not have to check the battery electrolyte level or add distilled water. Clean the battery terminals if they become dirty or corroded.

Do not remove the battery cap seals. There is no need to remove the cap when charging.

#### NOTICE

An improperly disposed of battery can be harmful to the environment and human health. Always confirm local regulations for proper battery disposal instruction.

#### What to do in an emergency

If any of the following occur, immediately see your doctor.

- Electrolyte splashes into your eyes:
  - ▶ Wash your eyes repeatedly with cool water for at least 15 minutes. Using water under pressure can damage your eyes.

- Electrolyte splashes onto your skin:
  - ▶ Remove affected clothing and wash your skin thoroughly using water.
- Electrolyte splashes into your mouth:
  - ▶ Rinse mouth thoroughly with water, and do not swallow.

### WARNING

The battery gives off explosive hydrogen gas during normal operation.

A spark or flame can cause the battery to explode with enough force to kill or seriously hurt you.

Wear protective clothing and a face shield, or have a skilled mechanic do the battery servicing.

**WARNING:** Battery posts, terminals, and related accessories contain lead and lead compounds.

**Wash your hands after handling.**

## Cleaning the Battery Terminals

1. Remove the battery. ➔ P. 75
2. If the terminals are starting to corrode and are coated with a white substance, wash with warm water and wipe clean.
3. If the terminals are heavily corroded, clean and polish the terminals with a wire brush or sandpaper. Wear safety glasses.

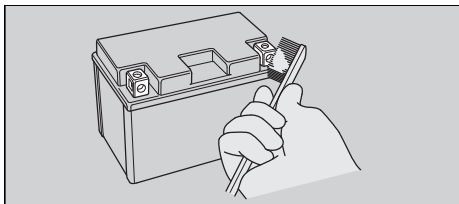

4. After cleaning, reinstall the battery.

The battery has a limited life span. Consult your dealer about when you should replace the battery. Always replace the battery with another maintenance-free battery of the same type.

## Charging

If you use electrical accessories that drain the battery or you do not ride frequently, we recommend that you charge the battery every 30 days using a charger designed specifically for your Honda, which can be purchased from your dealer. Read the information that came with your battery charger and follow the instructions on the battery. Avoid using an automobile-type battery charger, as these can overheat a motorcycle battery and cause permanent damage.

Make sure the ignition switch is in the OFF position before charging the battery.

### NOTICE

Improper charging can damage the battery. If you can't charge the battery or it appears unable to hold a charge, contact your dealer.

### NOTICE

Jump starting using an automobile battery can damage your vehicle's electrical system and is not recommended. Bump starting is also not recommended.

### NOTICE

Installing non-Honda electrical accessories can overload the electrical system, discharging the battery and possibly damaging the system.

## Fuses

Fuses protect the electrical circuits on your vehicle. If something electrical on your vehicle stops working, check for and replace any blown fuses. ➤ P. 98

### Inspecting and Replacing Fuses

Turn the ignition switch to the OFF position to remove and inspect fuses. If a fuse is blown, replace with a fuse of the same rating. For fuse ratings, see "Specifications." ➤ P. 127

### Blown fuse

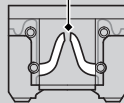

### NOTICE

Replacing a fuse with one that has a higher rating greatly increases the chance of damage to the electrical system.

If a fuse fails repeatedly, you likely have an electrical fault. Have your vehicle inspected by your dealer.



## Engine Oil

Engine oil consumption varies and oil quality deteriorates according to riding conditions and time elapsed.

Check the engine oil level regularly, and add the recommended engine oil if necessary. Dirty oil or old oil should be changed as soon as possible.

### Selecting the Engine Oil

For recommended engine oil, see "Specifications." P. 126

If you use non-Honda engine oil, check the label to make sure that the oil satisfies all of the following standards:

- JASO T 903 standard\*<sup>1</sup>: MB
- SAE standard\*<sup>2</sup>: 10W-30
- API classification\*<sup>3</sup>: SJ or higher

- \*1. The JASO T 903 standard is an index for engine oils for 4-stroke motorcycle engines. There are two classes: MA and MB. For example, the following label shows the MB classification.

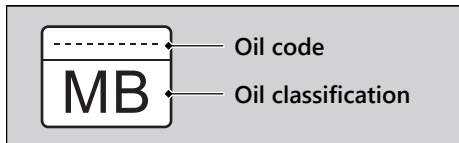

- \*2. The SAE standard grades oils by their viscosity.
- \*3. The API classification specifies the quality and performance rating of engine oils. Use SJ or higher oils, excluding oils marked as "Energy Conserving" or "Resource Conserving" on the circular API service symbol.

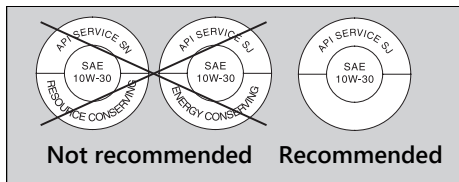

### Brake Fluid

Do not add or replace brake fluid, except in an emergency. Use only fresh brake fluid from a sealed container. If you do add fluid, have the brake system serviced by your dealer as soon as possible.

#### NOTICE

Brake fluid can damage plastic and painted surfaces.  
Wipe up spills immediately and wash thoroughly.

#### Recommended brake fluid:

Honda DOT 3 or DOT 4 Brake Fluid or equivalent

### Recommended Coolant

Pro Honda HP Coolant is a pre-mixed solution of antifreeze and distilled water.

#### Concentration:

50% antifreeze and 50% distilled water

A concentration of antifreeze below 40% will not provide proper corrosion and cold temperature protection.  
A concentration of up to 60% will provide better protection in colder climates.

#### NOTICE

Using coolant not specified for aluminum engines or tap/mineral water can cause corrosion.

## Crankcase Breather

Service more frequently when riding in rain, at full throttle, or after the vehicle is washed or overturned. Service if the deposit level can be seen in the transparent section of the drain tube.

If the drain tube overflows, the air filter may become contaminated with engine oil, causing poor engine performance.

## Tires (Inspecting/Replacing)

### Checking the Air Pressure

Visually inspect your tires and use an air pressure gauge to measure the air pressure at least once a month or any time you think the tires look low. Always check air pressure when your tires are cold.

### Inspecting for Damage

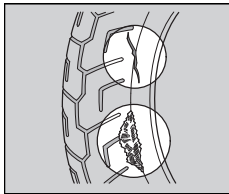

Inspect the tires for cuts, slits, or cracks that expose fabric or cords, or nails or other foreign objects embedded in the side of the tire or the tread.

Also inspect for any unusual bumps or bulges in the side walls of the tires.

### Inspecting for Abnormal Wear

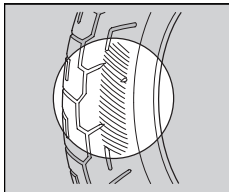

Inspect the tires for signs of abnormal wear on the contact surface.

### Inspecting Tread Depth

Inspect the tread wear indicators. If they become visible, replace the tires immediately. For safe riding, you should replace the tires when the minimum tread depth is reached.

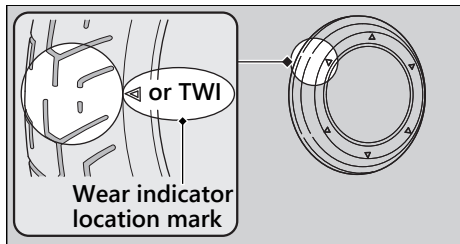

### **⚠️ WARNING**

Riding on tires that are excessively worn or improperly inflated can cause a crash in which you can be seriously hurt or killed.

Follow all instructions in this owner's manual regarding tire inflation and maintenance.

Have your tires replaced by your dealer. For recommended tires, air pressure, and minimum tread depth, see "Specifications."

➤ P. 126

Follow these guidelines whenever you replace tires:

- Use the recommended tires or their equivalents of the same size, construction, speed rating, and load range.
- Do not install a tube inside a tubeless tire on this vehicle. Excessive heat build-up can cause the tube to burst.
- Use only tubeless tires on this vehicle. The rims are designed for tubeless tires, and during hard acceleration or braking, a tube-type tire could slip on the rim and cause the tire to rapidly deflate.

## **WARNING**

Installing improper tires on your vehicle can adversely affect handling and stability, and can cause a crash in which you can be seriously hurt or killed.

Always use the size and type of tires recommended in this owner's manual.

### Tire Service Life

The service life of your tires is dependent on many factors, including, but not limited to, riding habits, road conditions, vehicle loading, tire air pressure, maintenance history, speed, and environmental conditions (even when the tires are not in use).

In addition to your regular inspections and maintenance, it is recommended that you have annual inspections performed once the tires reach 5 years old. It is also recommended that all tires be removed from service after 10 years from the date of manufacture, regardless of their condition or state of wear.

The last four digits of the TIN (tire identification number) indicate the date of manufacture.

### Tire Identification Number (TIN)

The tire identification number (TIN) is a group of numbers and letters located on the sidewall of the tire.

①      ②      ③

#### DOT XXXX XXXX 22 09

DOT:            This indicates that the tire meets all requirements of the U.S. Department of Transportation.

① XXXX:      Factory code

② XXXX:      Tire type code

③ 22 09:      Date of manufacture (week & year).  
Example: week 22 in year 09.

#### Tire Labeling Example

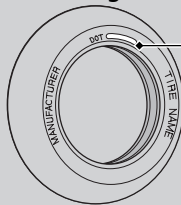

Tire identification number (TIN)

## Battery

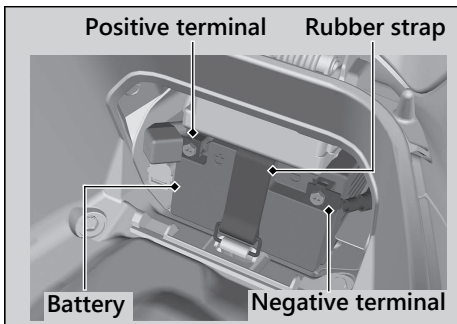

### Removal

Make sure the ignition switch is in the OFF position.

1. Remove the battery cover. ➤ P. 76
2. Unhook the rubber strap.
3. Disconnect the negative  $\ominus$  terminal from the battery.

4. Disconnect the positive  $\oplus$  terminal from the battery.
5. Remove the battery, taking care not to drop the terminal nuts.

### Installation

Install the parts in the reverse order of removal. Always connect the positive  $\oplus$  terminal first. Make sure bolts and nuts are tight.

Make sure the clock information is correct after the battery is reconnected. ➤ P. 26  
For proper handling of the battery, see "Maintenance Fundamentals." ➤ P. 66  
"Battery Goes Dead." ➤ P. 97

## Battery Cover

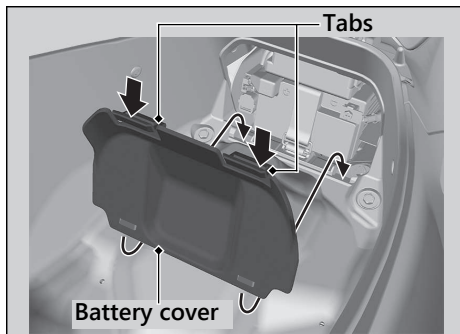

### Removal

1. Open the seat. ► P. 52
2. Press the tabs and remove the battery cover.

### Installation

Install the parts in the reverse order of removal.



## Checking the Engine Oil

1. If the engine is cold, idle the engine for 3 to 5 minutes.
2. Turn the ignition switch to the OFF position and wait for 2 to 3 minutes.
3. Place your vehicle on its center stand on a firm, level surface.
4. Remove the oil fill cap/dipstick and wipe it clean.
5. Insert the oil fill cap/dipstick until it seats, but don't screw it in.
6. Check that the oil level is between the upper level and lower level marks on the oil fill cap/dipstick.
7. Securely install the oil fill cap/dipstick.

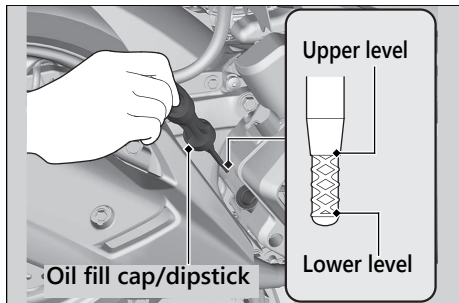

## Adding Engine Oil

---

If the engine oil is below or near the lower level mark, add the recommended engine oil.

► P. 69, ► P. 126

1. Remove the oil fill cap/dipstick. Add the recommended oil until it reaches the upper level mark.
  - Place your vehicle on its center stand on a firm, level surface when checking the oil level.
  - Do not overfill above the upper level mark.
  - Make sure no foreign objects enter the oil filler opening.
  - Wipe up any spills immediately.
2. Securely reinstall the oil fill cap/dipstick.

### NOTICE

Overfilling with oil or operating with insufficient oil can cause damage to your engine. Do not mix different brands and grades of oil.

For the recommended oil and oil selection guidelines, see “Maintenance Fundamentals.”

► P. 69

## Checking the Coolant

Check the coolant level in the reserve tank while the engine is cold.

1. Place your vehicle on its center stand on a firm, level surface.
2. Check that the coolant level is between the UPPER level and LOWER level marks on the reserve tank.

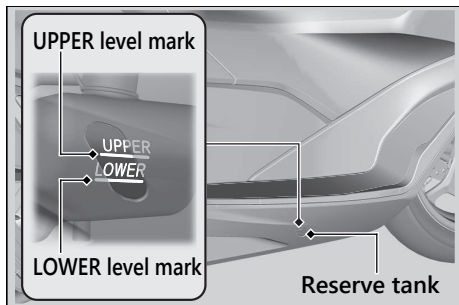

If the coolant level is dropping noticeably or the reserve tank is empty, you likely have a serious leak. Have your vehicle inspected by your dealer.

## Adding Coolant

If the coolant level is below the LOWER level mark, add the recommended coolant (► P. 70) until the level reaches the UPPER level mark.

Add fluid only from the reserve tank cap and do not remove the radiator cap.

1. Pull the floor mat off.
2. Remove the reserve tank lid by inserting a flat head screwdriver covered with a protective cloth into the slit on the right side floor.

## Coolant ► Adding Coolant

3. Remove the reserve tank cap and add fluid while monitoring the coolant level.
  - Do not overfill above the UPPER level mark.
  - Make sure no foreign objects enter the reserve tank opening.
4. Securely reinstall the reserve tank cap.
5. Install the reserve tank lid and floor mat.

**⚠ WARNING**

Removing the radiator cap while the engine is hot can cause the coolant to spray out, potentially scalding you.

Always let the engine and radiator cool down before removing the radiator cap.

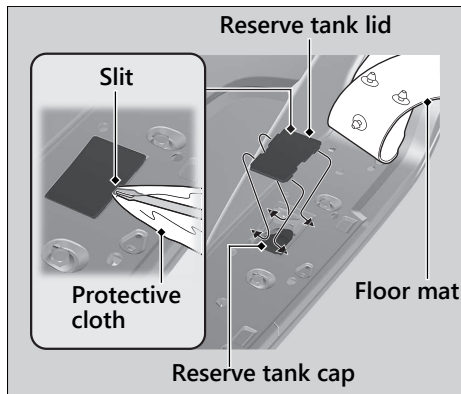

## Checking Brake Fluid

1. Place your vehicle in an upright position on a firm, level surface.
2. Check that the brake fluid reservoir cap is horizontal and that the fluid level is:  
**Front brake** above the LWR mark.  
**Combi brake (Except ABS type)** between the LOWER level and UPPER level marks.

If the brake fluid level in either reservoir is below the LWR mark or LOWER level mark or the brake lever freeplay becomes excessive, inspect the brake pads for wear.

If the brake pads are not worn, you most likely have a leak. Have your vehicle inspected by your dealer.

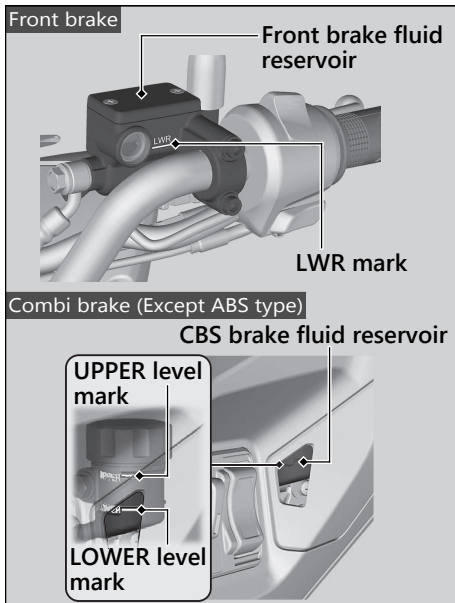

## Inspecting the Front Brake Pads

Check the condition of the brake pad wear indicators.

The pads need to be replaced if a brake pad is worn to the bottom of the indicator.

1. Inspect the brake pads from in front of the brake caliper.

If necessary, have the pads replaced by your dealer.

Always replace both left and right brake pads at the same time.

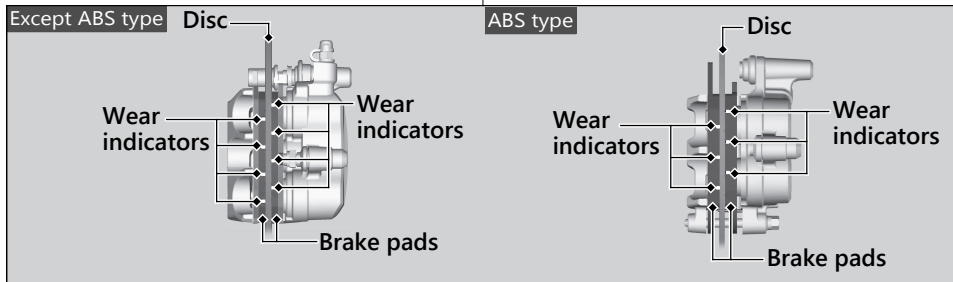

## Inspecting the Rear Brake Lever Freeplay

1. Place the vehicle on its center stand.
2. Measure the distance the rear brake lever moves before the brake takes hold.

### Freeplay at the tip of the brake lever:

3/8 - 13/16 in (10 - 20 mm)

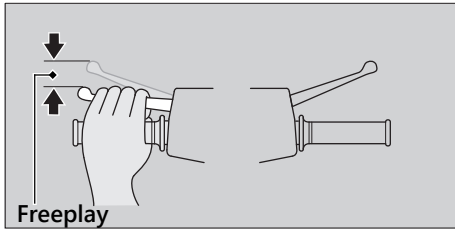

Check the brake cable for kinks or signs of wear. If necessary, have it replaced by your dealer.

Lubricate the brake cable with a commercially available cable lubricant to prevent premature wear and corrosion. Make sure the brake arm, spring and fastener are in good condition.

## Adjusting the Rear Brake Lever Freeplay

Adjust the freeplay of the brake lever with the front wheel pointed straight ahead. Make sure the cut-out on the adjusting nut is seated on the brake arm pin when adjusting the freeplay.

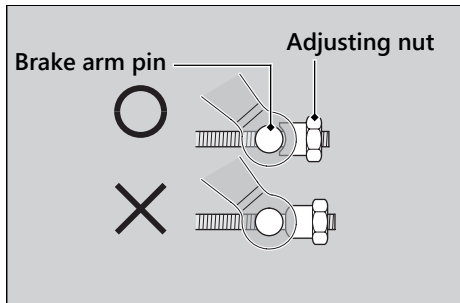

If proper adjustment cannot be obtained by this method, see your dealer.

1. Adjust by turning the rear brake adjusting nut a half-turn at a time.

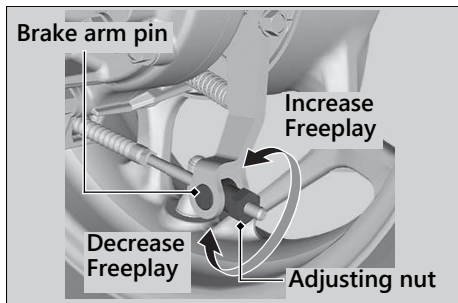

2. Apply the brake several times and check for free wheel rotation after the brake lever is released.



3. Push the brake arm to confirm that there is a gap between the rear brake adjusting nut and brake arm pin.

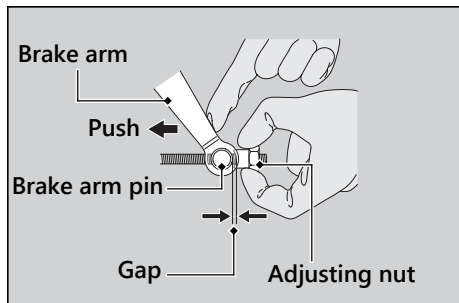

After adjustment, confirm the freeplay of the brake lever.

Make sure the brake arm, spring and fastener are in good condition.

**NOTICE**

Do not turn the adjuster beyond its natural limits.

## Inspecting the Rear Brake Shoe Wear

The rear brake is equipped with a brake wear indicator.

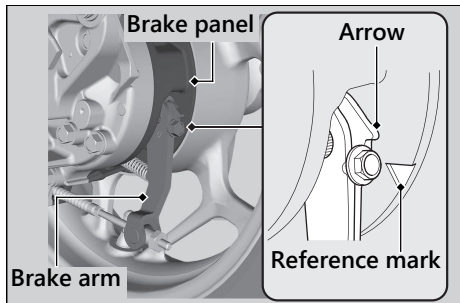

When the brake is applied, an arrow attached to the brake arm moves toward a reference mark on the brake panel. If the arrow aligns with the reference mark on full application of the brake, the brake shoes must be replaced. See your dealer for this service.

When brake service is necessary, see your dealer. Use only Honda Genuine Parts or their equivalent.

### Checking the Side Stand

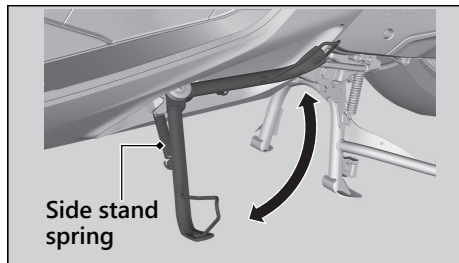

1. Place your vehicle on its center stand on a firm, level surface.
2. Check that the side stand operates smoothly. If the side stand is stiff or squeaky, clean the pivot area and lubricate the pivot bolt with clean grease.
3. Check the spring for damage or loss of tension.
4. Sit on the vehicle and raise the side stand.
5. Start the engine.
6. Lower the side stand all the way. The engine should stop as you lower the side stand. If the engine doesn't stop, have your vehicle inspected by your dealer.

## Checking the Throttle

With the engine off, check that the throttle rotates smoothly from fully closed to fully open in all steering positions and throttle freeplay is correct. If the throttle does not move smoothly, close automatically, or if the cable is damaged, have the vehicle inspected by your dealer.

### Freeplay at the throttle grip flange:

1/16 - 1/4 in (2 - 6 mm)

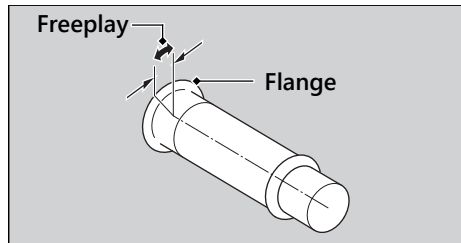

# Troubleshooting

<b>Engine Will Not Start</b> .....	P. 90	Burned-out Light Bulb.....	P. 97
<b>Overheating (High coolant temperature indicator is on)</b> .....	P. 91	Blown Fuse .....	P. 98
<b>Warning Indicators On or Flashing</b> .....	P. 92	<b>Unstable Engine Operation Occurs Intermittently</b> .....	P. 100
PGM-FI (Programmed Fuel Injection)			
Malfunction Indicator Lamp (MIL).....	P. 92		
Battery Charging Condition indicator .....	P. 92		
ABS (Anti-lock Brake System) Indicator .....	P. 93		
Torque Control Indicator .....	P. 94		
<b>Other Warning Indications</b> .....	P. 95		
Fuel Gauge Failure Indication .....	P. 95		
<b>Tire Puncture</b> .....	P. 96		
<b>Electrical Trouble</b> .....	P. 97		
Battery Goes Dead .....	P. 97		

## Starter Motor Operates But Engine Does Not Start

---

Check the following items:

- Check the correct engine starting sequence. ➔ P. 43
- Check that there is gasoline in the fuel tank.
- Check if the PGM-FI malfunction indicator lamp (MIL) is on.
  - ▶ If the indicator lamp is on, contact your dealer as soon as possible.

## Starter Motor Does Not Operate

---

Check the following items:

- Check the correct engine starting sequence. ➔ P. 43
- Make sure engine stop switch is in the (Run) position. ➔ P. 36
- Check for a blown fuse. ➔ P. 98
- Check for a loose battery connection (➔ P. 75) or battery terminal corrosion (➔ P. 66).
- Check the condition of the battery.
  - ➔ P. 97

If the problem continues, have your vehicle inspected by your dealer.

## Overheating (High coolant temperature indicator is on)

The engine is overheating when the following occurs:

- High coolant temperature indicator comes on.
- Acceleration becomes sluggish.

If this occurs, pull safely to the side of the road and perform the following procedure. Extended fast idling may cause the high coolant temperature indicator to come on.

### NOTICE

Continuing to ride with an overheated engine can cause serious damage to the engine.

1. Stop the engine using the ignition switch.
2. Allow the engine to cool with the ignition switch in the OFF position.
3. After the engine has cooled, inspect the radiator hose and check if there is a leak.  
➔ P. 79  
**If there is a leak:**  
Do not start the engine. Transport your vehicle to your dealer.
4. Check the coolant level in the reserve tank. ➔ P. 79  
▶ Add coolant as necessary.
5. If 1-4 check normal, you may continue riding, but closely monitor the high coolant temperature indicator.

### **PGM-FI (Programmed Fuel Injection) Malfunction Indicator Lamp (MIL)**

---

If the indicator comes on while riding, you may have a serious problem with the PGM-FI system. Reduce speed and have your vehicle inspected by your dealer as soon as possible.

### **Battery Charging Condition indicator**

---

If the indicator comes on while riding, you may have a condition of low battery voltage or battery performance degradation. Have your vehicle inspected by your dealer.

- ▶ If the battery does not have enough voltage to power the indicator system, the indicator may not come on.



## ABS (Anti-lock Brake System) Indicator

---

### ABS type

If the indicator operates in one of the following ways, you may have a serious problem with the ABS. Reduce your speed and have your vehicle inspected by your dealer as soon as possible.

- Indicator comes on or starts flashing while riding.
- Indicator does not come on when the ignition switch is in the ON position.
- Indicator does not go off at speeds above 6 mph (10 km/h).

If the ABS indicator stays on, your brakes will continue to work as a conventional system, but without the anti-locking function.

The ABS indicator may flash if you turn the rear wheel while the rear wheel is lifted off the ground. In this case, turn the ignition switch to the OFF position, and then to the ON position again. The ABS indicator will go off after your speed reaches 19 mph (30 km/h).

## Torque Control Indicator

---

### ABS type

If the indicator operates in one of the following ways, you may have a serious problem with the Torque Control. Reduce your speed and have your vehicle inspected by your dealer as soon as possible.

- Indicator comes and stays on (solid) while riding.
- Indicator does not come on when the ignition switch is turned to the ON position.
- Indicator does not go off at speeds above 2 mph (3 km/h).

Even when the Torque Control indicator is on, your vehicle will have normal riding ability without Torque Control function.

- When the indicator comes on while the Torque Control is in operation, you will have to completely close the throttle to regain normal riding ability.

The Torque Control indicator may come on if you rotate the rear wheel while your vehicle is lifted off the ground. In this case, turn the ignition switch to the OFF position, and then to the ON position again. The Torque Control indicator will go off after your speed reaches 2 mph (3 km/h).

## Fuel Gauge Failure Indication

If the fuel system has an error, the fuel gauge indicators will be displayed as shown in the illustrations.

If this occurs, see your dealer as soon as possible.

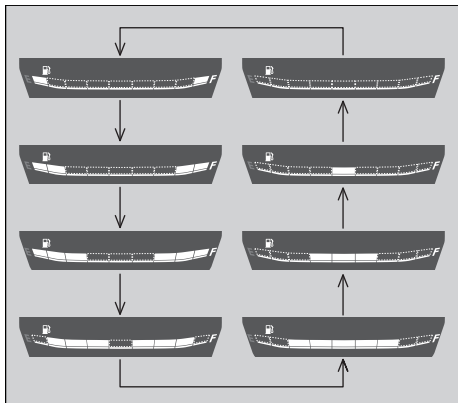
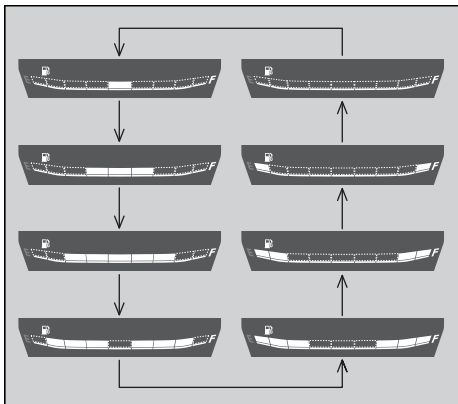

## Tire Puncture

Repairing a puncture or removing a wheel requires special tools and technical expertise. We recommend you have this type of service performed by your dealer.

After an emergency repair, always have the tire inspected/replaced by your dealer.

### Emergency Repair Using a Tire Repair Kit

---

If your tire has a minor puncture, you can make an emergency repair using a tubeless tire repair kit.

Follow the instructions provided with the emergency tire repair kit.

Riding your vehicle with a temporary tire repair is very risky. Do not exceed 30 mph (50 km/h). Have the tire replaced by your dealer as soon as possible.

### **WARNING**

Riding your vehicle with a temporary tire repair can be risky. If the temporary repair fails, you can crash and be seriously injured or killed.

If you must ride with a temporary tire repair, ride slowly and carefully and do not exceed 30 mph (50 km/h) until the tire is replaced.

### Battery Goes Dead

---

Charge the battery using a motorcycle battery charger.

Remove the battery from the vehicle before charging.

Do not use an automobile-type battery charger, as these can overheat a motorcycle battery and cause permanent damage. If the battery does not recover after recharging, contact your dealer.

#### NOTICE

Jump starting using an automobile battery can damage your vehicle's electrical system and is not recommended.

Bump starting is also not recommended.

### Burned-out Light Bulb

---

All light bulbs on the vehicle are LEDs. If any of the LED lights do not turn on, see your dealer for servicing.

## Blown Fuse

Before handling fuses, see “Inspecting and Replacing Fuses.” ► P. 68

### Fuse Box Fuses

1. Remove the battery cover. ► P. 76
2. Remove the fuse box cover.
3. Pull the main fuse and other fuses out one by one with the fuse puller located inside of the fuse box cover. Check for a blown fuse. Always replace a blown fuse with a spare fuse of the same rating.
4. Install the fuse box cover.
5. Install the battery cover.

#### NOTICE

If a fuse fails repeatedly, you likely have an electrical problem. Have your vehicle inspected by your dealer.

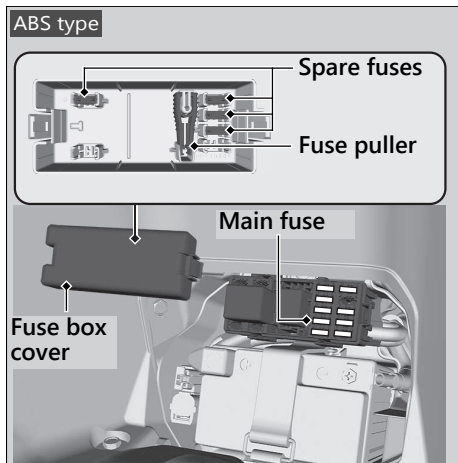

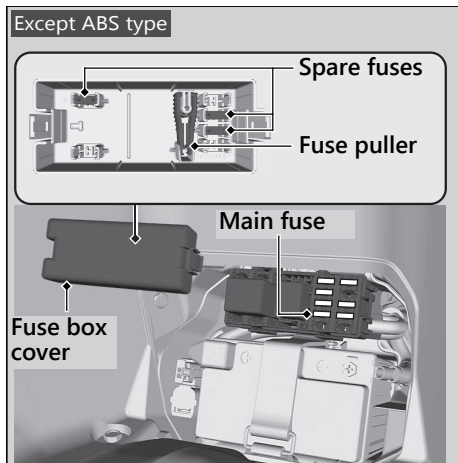

## Unstable Engine Operation Occurs Intermittently

If the fuel pump filter is clogged, unstable engine operation will occur intermittently while riding.

Even if this symptom occurs, you can continue to ride your vehicle.

If unstable engine operation occurs even if sufficient fuel is available, have your vehicle inspected by your dealer as soon as possible.



# Information

Keys.....	P. 102
Instruments, Controls, & Other Features...	P. 103
Caring for Your Vehicle.....	P. 104
Storing Your Vehicle.....	P. 108
Transporting Your Vehicle .....	P. 109
You & the Environment .....	P. 110
Vehicle Identification Number.....	P. 111
Emission Control Systems .....	P. 112
Catalytic Converter .....	P. 116
Oxygenated Fuels.....	P. 117
Authorized Manuals .....	P. 118
Warranty Coverage and Service .....	P. 119
Honda Contacts.....	P. 122
Reporting Safety Defects .....	P. 124

## Keys

### Ignition Key

Be sure to record the key number provided with the key number plate. Store the spare key and key number in a safe location.

To make a duplicate, take the spare key or the key number to your dealer.

If you lose all ignition keys and the key number, the ignition switch assembly will probably have to be removed by your dealer to determine the key number.

A metal key holder may cause damage to the area surrounding the ignition switch.

# Instruments, Controls, & Other Features

## Ignition Switch

Leaving the ignition switch in the ON position with the engine stopped will drain the battery.

Do not turn the key while riding.

## Engine Stop Switch

Do not use the engine stop switch except in an emergency. Doing so when riding will cause the engine to suddenly turn off, making riding unsafe.

If you stop the engine using the engine stop switch, turn the ignition switch to the OFF position. Failing to do so will drain the battery.

## Odometer

The display remains at 999,999 when the odometer exceeds 999,999.

## Tripmeter

The tripmeter resets to 0.0 when the trip mileage exceeds 9,999.9.

## Document Bag

The owner's manual, registration, and insurance information can be stored in the plastic document bag located underside of the seat.

## Caring for Your Vehicle

Frequent cleaning and polishing is important to ensure the life of your Honda. A clean vehicle makes it easier to spot potential problems. In particular, seawater and salts used to prevent ice on roads promote the formation of corrosion. Always wash your vehicle thoroughly after riding on coastal or treated roads.

### Washing

Allow the engine, muffler, brakes, and other high-temperature parts to cool before washing.

1. Rinse your vehicle thoroughly using a low pressure garden hose to remove loose dirt.
2. If necessary, use a sponge or a soft towel with mild cleaner to remove road grime.
  - ▶ Clean the windscreen, headlight lens, panels, and other plastic components with extra care to avoid scratching them. Avoid directing water into the air cleaner, muffler, and electrical parts.

3. Thoroughly rinse your vehicle with plenty of clean water and dry with a soft, clean cloth.
4. After the vehicle dries, lubricate any moving parts.
  - ▶ Make sure that no lubricant spills onto the brakes or tires. Brake discs, pads, drum or shoes contaminated with oil will suffer greatly reduced braking effectiveness and can lead to a crash.
5. Apply a coat of wax to prevent corrosion.
  - ▶ Avoid products that contain harsh detergents or chemical solvents. These can damage the metal, paint, and plastic on your vehicle. Keep the wax clear of the tires and brakes.
  - ▶ If your vehicle has any matte painted parts, do not apply a coat of wax to the matte painted surface.

## Washing Precautions

Follow these guidelines when washing:

- Do not use high-pressure washers:
    - ▶ High-pressure water cleaners can damage moving parts and electrical parts, rendering them inoperable.
    - ▶ Water in the air intake can be drawn into the throttle body and/or enter the air cleaner.
  - Do not direct water at the muffler:
    - ▶ Water in the muffler can prevent starting and causes rust in the muffler.
  - Dry the brakes:
    - ▶ Water adversely affects braking effectiveness. After washing, apply the brakes intermittently at low speed to help dry them.
  - Do not direct water under the seat:
    - ▶ Water in the under seat compartment can damage your documents and other belongings.
- 
- Do not direct water at the air cleaner:
    - ▶ Water in the air cleaner can prevent the engine from starting.
  - Do not direct water near the headlight:
    - ▶ The headlight's inside lens may fog temporarily after washing or while riding in the rain. This does not impact the headlight function.  
However, if you see a large amount of water or ice accumulated inside the lens(es), have your vehicle inspected by your dealer.
  - Do not use wax or polishing compounds on matte painted surfaces:
    - ▶ Use a soft cloth or sponge, plenty of water, and a mild detergent to clean matte painted surfaces. Dry with a soft clean cloth.

### Aluminum Components

Aluminum will corrode from contact with dirt, mud, or road salt. Clean aluminum parts regularly and follow these guidelines to avoid scratches:

- Do not use stiff brushes, steel wool, or cleaners containing abrasives.
- Avoid riding over or scraping against curbs.

### Panels

Follow these guidelines to prevent scratches and blemishes:

- Wash gently using a soft sponge and plenty of water.
- To remove stubborn stains, use diluted detergent and rinse thoroughly with plenty of water.
- Avoid getting gasoline, brake fluid, or detergents on the instruments, panels, or headlight.

## Windscreen

Using plenty of water, clean the windscreen with a soft cloth or sponge. (Avoid using detergents or any kind of chemical cleaner on the windscreen.) Dry with a soft, clean cloth.

### NOTICE

To avoid possible scratching or other damage, use only water and a soft cloth or sponge to clean the windscreen.

For a dirtier windscreen, use a diluted neutral detergent with a sponge and plenty of water. Make sure to wash off all the detergent. (Detergent residue may cause windscreen cracks.)

Replace the windscreen if scratches cannot be removed and they obstruct clear vision.

Take care to keep battery electrolyte, brake fluid, or other chemical solvents off the windscreen and screen garnish. They will damage the plastic.

## Exhaust Pipe and Muffler

If the exhaust pipe and muffler are painted, do not use a commercially available abrasive kitchen cleaning compound. Use a neutral detergent to clean the painted surface on the exhaust pipe and muffler. If you are not sure if your exhaust pipe and muffler are painted, contact your dealer.

## Storing Your Vehicle

If you store your vehicle outdoors, you should consider using a full-body cover.

If you won't be riding for an extended period, follow these guidelines:

- Wash your vehicle and wax all painted surfaces (except matte painted surfaces). Coat chrome pieces with rust-inhibiting oil.
- Place your vehicle on its center stand and position a block so that both tires are off the ground.
- After rain, remove the body cover and allow the vehicle to dry.
- Remove the battery (➡ P. 75) to prevent discharge. Fully charge the battery and then place it in a shaded, well-ventilated area.
  - ▶ If you leave the battery in place, disconnect the negative ⊖ terminal to prevent discharge.

After removing your vehicle from storage, inspect all maintenance items required by the Maintenance Schedule.

For more information about storage, refer to the *Honda Winter Storage Guide*, available from your dealer.



## Transporting Your Vehicle

If your vehicle needs to be transported, it should be carried on a motorcycle trailer or a flatbed truck or trailer that has a loading ramp or lifting platform and motorcycle tie-down straps. Never try to tow your vehicle with a wheel or wheels on the ground.

**NOTICE**

Towing your vehicle with a wheel or wheels on the ground can cause serious damage to the transmission.

## You & the Environment

Owning and riding a vehicle can be enjoyable, but you must do your part to protect the environment.

### Choose Sensible Cleaners

Use a biodegradable detergent when you wash your vehicle. Avoid aerosol spray cleaners that contain chlorofluorocarbons (CFCs) which damage the atmosphere's protective ozone layer.

### Recycle Wastes

Put oil and other toxic wastes in approved containers and take them to a recycling center. Call your local or state office of public works or environmental services to find a recycling center in your area and to get instructions on how to dispose of non-recyclable wastes. Do not place used engine oil in the trash or pour it down a drain or on the ground. Used oil, gasoline, coolant, and cleaning solvents contain poisons that can hurt refuse workers and contaminate drinking water, lakes, rivers, and oceans.

## Vehicle Identification Number

The VIN and engine serial number uniquely identify your vehicle and are required in order to register your vehicle. They may also be required when ordering replacement parts. You should record these numbers and keep them in a safe place.

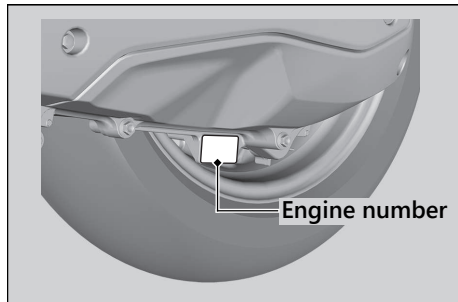
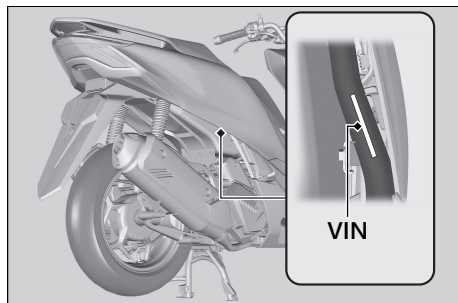
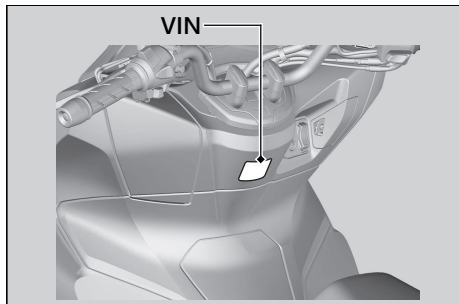

## Emission Control Systems

Your vehicle engine emits combustion byproducts, including carbon monoxide (CO), oxides of nitrogen (NOx), and hydrocarbons (HC). Gasoline evaporation also emits hydrocarbons. Controlling the production of NOx, CO, and HC is important for the environment.

### Exhaust Emission Requirements

The U.S. Environmental Protection Agency (EPA) and the California Air Resources Board (CARB) require that your vehicle comply with applicable exhaust, crankcase, and fuel permeation emission standards during its useful life, when operated and maintained according to the instructions provided.

CARB also requires that your vehicle comply with applicable evaporative emission requirements during its useful life, when operated and maintained according to the instructions provided.

Compliance with the terms of the Distributor's Warranties for Honda Scooter Emission Control Systems is necessary in order to maintain a valid emissions system warranty.

The Vehicle Emission Control Information label is attached to the inside of the center compartment. ➡ P. 52

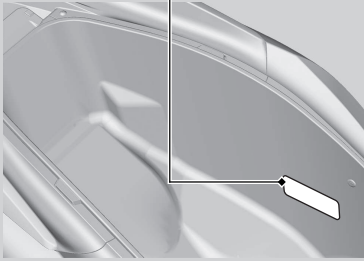
**Vehicle emission control information label****Noise Emission Requirements**

The EPA requires that vehicles built after January 1, 1983 comply with applicable noise emission standards for one year or 3,730 miles (6,000 km) after the time of purchase when operated and maintained according to the instructions provided.

**Exhaust Emission Control System**

The exhaust emission control system includes the following components that should not need adjustment, although periodic inspection by your dealer is recommended.

**PGM-FI System**

The PGM-FI (programmed fuel injection) system uses sequential multiport fuel injection, and is comprised of air intake, engine control, fuel control, and exhaust control subsystems. The engine control module (ECM) uses sensors to determine how much air enters the engine, and then controls how much fuel to inject.

### **Ignition Timing Control System**

The ignition timing control system adjusts the ignition timing to reduce the amount of HC, CO, and NO<sub>x</sub> produced.

### **Catalytic Converters**

The exhaust system contains one or more catalytic converters. Catalytic converters use a catalyst to convert most of the harmful exhaust gas compounds into harmless compounds.

### **Evaporative Emission Control System**

#### **50 STATE (meets California)**

An evaporative emissions control system uses a canister filled with charcoal to adsorb fuel vapor from the fuel tank while the engine is off. The vapor is drawn into the engine and burned while riding.

### **Crankcase Emissions Control System**

The engine is equipped with a closed crankcase system to prevent discharging crankcase emissions into the atmosphere. Blow-by gas is returned to the combustion chamber through the crankcase breather hose, air cleaner housing and throttle body.

### **Fuel Permeation Emission Control**

The fuel tank, fuel hoses, and fuel vapor charge hoses use fuel permeation control technologies to prevent fuel vapor emissions. Tampering with these components to reduce or defeat the effectiveness of the fuel permeation technologies is prohibited.

## Noise Emission Control System

### **TAMPERING WITH THE NOISE CONTROL SYSTEM IS PROHIBITED:**

U. S. federal law prohibits the following acts or the causing thereof: (1) The removal or rendering inoperative by any person, other than for purposes of maintenance, repair or replacement, of any device or element of design incorporated into any new vehicle for the purpose of noise control prior to its sale or delivery to the ultimate purchaser or while it is in use; or (2) the use of the vehicle after such device or element of design has been removed or rendered inoperative by any person.

### **AMONG THOSE ACTS PRESUMED TO CONSTITUTE TAMPERING ARE THE FOLLOWING ACTS:**

- Removal of, or puncturing the muffler, baffles, header pipes or any other component which conducts exhaust gases.

- Removal of, or puncturing of any part of the intake system.
- Lack of proper maintenance.
- Removing or disabling any emissions compliance component, or replacing any compliance component with a noncompliant component.

## Problems Affecting Vehicle Exhaust Emissions

Have your vehicle inspected and repaired by your dealer if you experience any of the following symptoms:

- Hard starting or stalling after starting
- Rough idling
- Misfiring or backfiring during acceleration
- Poor engine performance and poor fuel economy

## Catalytic Converter

This vehicle is equipped with a three-way catalytic converter. The catalytic converter contains precious metals that serve as catalysts in high temperature chemical reactions that convert hydrocarbons (HC), carbon monoxide (CO), and oxides of nitrogen (NOx) in the exhaust gases into safe compounds.

A defective catalytic converter contributes to air pollution and can impair your engine's performance. A replacement unit must be an original Honda part or equivalent.

Follow these guidelines to protect your vehicle's catalytic converter:

- Always use unleaded gasoline. Leaded gasoline will damage the catalytic converter.
- Keep the engine in good running condition. A poorly running engine can cause the catalytic converter to overheat, causing damage to the converter or the vehicle.
- If your engine is misfiring, backfiring, stalling, or otherwise not running properly, stop riding and turn off the engine. Have your vehicle serviced as soon as possible.



## Oxygenated Fuels

Some conventional fuels blended with alcohol or an ether compound are available in some locales to help reduce emissions to meet clean air standards. These gasolines are collectively referred to as oxygenated fuels. If you plan to use oxygenated fuel, check that it is unleaded and meets the minimum octane rating and blend requirement.

The following fuel blends have been approved for use in your vehicle:

- Ethanol (ethyl alcohol) up to 10% by volume.
  - ▶ Gasoline containing ethanol may be marketed under the name Gasohol.
- Do not use gasoline containing methanol (methyl alcohol).

If you accidentally fill your fuel tank with an oxygenated fuel containing higher percentages, you may experience performance problems. To resolve the problem, have your dealer drain the fuel tank and replace with the correct fuel. Fuel system or performance problems resulting from the use of an oxygenated fuel containing higher percentages are not covered by your warranty.

### NOTICE

Improper use of oxygenated fuels can damage metal, rubber, and plastic parts of your fuel system.

Oxygenated fuel can also damage paint.

Damage caused by spilled fuel is not covered by warranty.

If you notice any undesirable operating symptoms or performance problems, try a different brand of gasoline.

## Authorized Manuals

The Service Manual used by your authorized dealer is available from your Honda dealer or Helm, Inc.

Also available, but not necessary to service your model, is the Honda Common Service Manual, which explains basic service information for various systems on Honda motorcycles, scooters, ATV, and SxS.

The Winter Storage Guide in conjunction with the Owner's Manual and Service Manual can help you prepare your Honda motorcycle, scooter, ATV, and SxS for winter storage.

These Honda manuals are written for the professional technician. However, if you possess the proper tools, observe the safety standards, and are mechanically capable, you should find them easy to use.

Special Honda tools are necessary for some procedures.

**Order online: [www.helminc.com](http://www.helminc.com)**

**Order Toll Free: 1-888-CYCLE93**

(1-888-292-5393)

(NOTE: For Credit Card Orders Only)

Monday - Friday 8:00 AM - 6:00 PM ET

Description
2022 PCX150/A Service Manual
Common Service Manual (61CSM00)
Winter Storage Guide (S9507)
2022 PCX150/A Owner's Manual

## Warranty Coverage and Service

### Coverage

Your new Honda is covered by the following warranties:

- Vehicle Limited Warranty
- Emission Control System Warranty
- Noise Control Warranty

The responsibilities, restrictions, and exclusions that apply to these warranties are explained in the Warranties Booklet given to you by your Honda dealer at the time of purchase. Always keep your Honda owner's card with your Warranties Booklet.

It is important to realize that your warranty applies only to defects in material or workmanship of your Honda. Your warranty coverage does not apply to the normal wear

and deterioration associated with use of the vehicle.

Your warranty coverage is not voided if you perform your own maintenance. However, failures that occur due directly to improper maintenance are not covered by these warranties.

You can extend almost all of your warranty coverage through the HondaCare® Protection Plan. For more information, see your Honda dealer.

### Statement on Warranty Coverage for Aftermarket and Recycled Parts

The Magnuson-Moss Warranty Act, 15 U.S.C. s. 2301 et seq., makes it illegal for motor vehicle manufacturers to void a motor vehicle warranty or deny warranty coverage solely because an aftermarket or recycled part has been used to repair the vehicle or someone other than the authorized service provider performed service on the vehicle. This provision does not apply to a new motor vehicle purchased solely for commercial or industrial use.

Under federal law, a manufacturer may deny warranty coverage and charge for repairs to a vehicle if it is discovered that an aftermarket or recycled part installed on the vehicle is defective or was installed incorrectly and caused damage to another part of the vehicle otherwise covered under warranty. The Federal Trade Commission requires that a manufacturer demonstrate that an aftermarket or recycled part or service performed by a person other than an

authorized service provider caused damage to another part of the vehicle otherwise covered under warranty before denying warranty coverage. Additionally, federal law allows a manufacturer to void a motor vehicle warranty or deny warranty coverage if the manufacturer provides the article or service to consumers free of charge under the warranty or the manufacturer has secured a waiver from the Federal Trade Commission.

### Service

Please remember that maintenance recommended in the Maintenance Schedule is not included in your warranty coverage.

If you believe you have a problem with your vehicle, call the service department of your Honda dealer. Make an appointment for an inspection and diagnosis. You will be asked to authorize that inspection, and your dealer will return the results of the inspection. If a problem exists and is covered under warranty, your dealer will perform the warranty repairs. If you have any questions about your warranty coverage or the nature of the repair, talk to the Service Manager of your Honda dealer.

If a misunderstanding occurs and you aren't satisfied with your dealer's handling of the situation, we suggest you discuss your problem with the appropriate member of the dealership's management team. If you are still not satisfied, contact the owner of the dealership or their designated representative.

## Honda Contacts

### **American Honda Motor Co., Inc.**

If you wish to contact Honda directly to comment on your experiences with your vehicle or with your dealer, please send your comments using one of the following methods:



#### **POST MAIL**

Powersports Customer Relations  
American Honda Motor Co., Inc.  
P.O. Box 2200, Torrance, CA 90509-2200  
Mailstop: 100-4W-5F



#### **PHONE**

Telephone: (866) 784-1870



#### **ONLINE CUSTOMER SERVICE**

Website: <https://powersports.honda.com/contact-us>

Please include the following information in your letter:

- Name, address, and telephone number
- Product model, year, and VIN
- Date of purchase
- Dealer name and address

We will likely ask your Honda dealer to respond, or possibly acknowledge your comments directly.

## Your Honda Dealer

The service department of your Honda dealer offers trained personnel to perform regular maintenance and unexpected repairs. It has the latest available service information from Honda and also handles warranty inspections and repairs.

The parts department offers Honda Genuine Parts, Pro Honda products and Honda Accessories that provide the same quality that went into your vehicle.

The sales department offers the HondaCare<sup>®</sup> Protection Plan to extend almost all of your warranty coverage.

Your Honda dealer can also supply information about riding events and information about safety training available in your local area.

## Reporting Safety Defects

If you believe that your vehicle has a defect which could cause a crash or could cause injury or death, you should immediately inform the National Highway Traffic Safety Administration (NHTSA) in addition to notifying American Honda Motor Co., Inc.

If NHTSA receives similar complaints, it may open an investigation, and if it finds that a safety defect exists in a group of vehicles, it may order a recall and remedy campaign. However, NHTSA cannot become involved in individual problems between you, your dealer, or American Honda Motor Co., Inc.

To contact NHTSA, you may call the Vehicle Safety Hotline toll-free at:  
1-888-327-4236

(TTY: 1-800-424-9153); go to  
*<https://www.safercar.gov>*;

or write to:

Administrator, NHTSA,  
1200 New Jersey Avenue, SE.,  
Washington, DC 20590.

You can also obtain other information about motor vehicle safety from:

*<https://www.safercar.gov>*.



# Specifications

## ■ Main Components

Overall length	76.2 in (1,935 mm)
Overall width	29.1 in (740 mm)
Overall height	43.5 in (1,105 mm)
Wheelbase	51.8 in (1,315 mm)
Minimum ground clearance	5.3 in (135 mm)
Caster angle	26° 30'
Trail	3.1 in (80 mm)
Curb weight	<b>ABS type</b> 287 lb (130 kg)
	<b>Except ABS type</b> 289 lb (131 kg)
Maximum weight capacity *1	366 lb (166 kg)
Maximum luggage weight	Center compartment 22 lb (10 kg)
	Front box 2.0 lb (1.0 kg)
Passenger capacity	Rider and 1 passenger
Minimum turning radius	6.2 ft (1.90 m)
Displacement	9.6 cu-in (157 cm <sup>3</sup> )

\*1: Including rider, passenger, all luggage, and accessories.

Bore x stroke	2.36 x 2.19 in (60.0 x 55.5 mm)
Compression ratio	12.0:1
Fuel	Unleaded gasoline Recommended fuel octane number: Pump Octane Number (PON) 86 or higher
Tank capacity	2.14 US gal (8.1 L)
Battery	GTZ8V 12 V-7.0 Ah (10 HR)
Primary reduction	V-Matic (2.52:1-0.81:1)
Final reduction	9.589

## Specifications

### ■ Service Data

Tire size	Front	110/70-14M/C 50P
	Rear	130/70-13M/C 63P
Tire type	Bias-ply, tubeless	
Recommended Tires	Front	IRC SCT-006
	Rear	IRC SCT-007
Tire air pressure (With less than 200 lb (90 kg) of added weight)	Front	29 psi (200 kPa, 2.00 kgf/cm <sup>2</sup> )
	Rear	33 psi (225 kPa, 2.25 kgf/cm <sup>2</sup> )
Tire air pressure (With more than 200 lb (90 kg) of added weight)	Front	29 psi (200 kPa, 2.00 kgf/cm <sup>2</sup> )
	Rear	36 psi (250 kPa, 2.50 kgf/cm <sup>2</sup> )
Minimum tread depth	Front	0.06 in (1.5 mm)
	Rear	0.08 in (2.0 mm)
Spark plug	(standard)	LMAR8L-9 (NGK)
Spark plug gap	0.03 - 0.04 in (0.8 - 0.9 mm)	
Idle speed	(non-adjustable)	1,700 ± 100 rpm
Recommended engine oil	API Service Classification SJ or higher except oils labeled as energy conserving or resource conserving on the circular API service label, SAE10W-30, JASO T 903 standard MB, Pro Honda HP4M 4-stroke oil or an equivalent motorcycle oil	

Engine oil capacity	After draining	0.8 US qt (0.8 L)
	After draining & cleaning strainer screen	0.90 US qt (0.85 L)
	After disassembly	1.0 US qt (0.9 L)
Transmission oil capacity	After draining	0.13 US qt (0.12 L)
	After disassembly	0.15 US qt (0.14 L)
Recommended brake fluid	Honda DOT 3 or DOT 4 Brake Fluid	
Cooling system capacity	0.53 US qt (0.50 L)	
Recommended coolant	Pro Honda HP Coolant	

## ■ Bulbs

Headlight	LED
Brake light/Taillight	LED
Front turn signal	LED
Rear turn signal	LED
License plate light	LED
Position lights	LED

## ■ Fuses

Main fuse	30 A	
Other fuse	<b>ABS type</b>	15 A, 10 A, 7.5 A
	<b>Except ABS type</b>	10 A, 7.5 A

## Information Record

VIN	
Engine No.	
Color Label & Code	
Owner's Name	
Address	
City/State	
Phone	
Dealer's Name	
Address	
City/State	
Phone	
Service Manager	

California Proposition 65 Warning

 **WARNING:** Operating, servicing and maintaining a passenger vehicle or off-highway motor vehicle can expose you to chemicals including engine exhaust, carbon monoxide, phthalates, and lead, which are known to the State of California to cause cancer and birth defects or other reproductive harm. To minimize exposure, avoid breathing exhaust, do not idle the engine except as necessary, service your vehicle in a well-ventilated area and wear gloves or wash your hands frequently when servicing your vehicle. For more information go to [www.P65Warnings.ca.gov/passenger-vehicle](http://www.P65Warnings.ca.gov/passenger-vehicle).

**HONDA**  
The Power of Dreams

**RIDE  
RED**

31K1ZA10  
00X31-K1Z-A100

PRINTED IN USA