

Contents

Motorcycle Safety P. 2

Operation Guide P. 16

Maintenance P. 51

Troubleshooting P. 105

Information P. 124

Specifications P. 147

Index P. 151

Welcome

Congratulations on your purchase of a new Honda motorcycle. Your selection of a Honda makes you part of a worldwide family of satisfied customers who appreciate Honda's reputation for building quality into every product.

To ensure your safety and riding pleasure:

- Read this owner's manual carefully.
- Follow all recommendations and procedures contained in this manual.
- Pay close attention to safety messages contained in this manual and on the motorcycle.

To protect your investment, we urge you to take responsibility for keeping your motorcycle well serviced and maintained. Also, observe the break-in guidelines, and always perform the pre-ride inspection and other periodic checks in this manual.

When service is required, remember that your Honda dealer knows your motorcycle best. If you have the required mechanical "know-how" and tools, you can purchase an official Honda Service Manual to help you perform many maintenance and repair tasks.

➤ P. 141

Read the warranty information thoroughly so that you understand the warranty coverage and that you are aware of your rights and responsibilities. ➤ P. 142

You may also want to visit our website at www.powersports.honda.com.

Canada www.honda.ca.

Happy riding!

A Few Words About Safety

Your safety, and the safety of others, is very important. Operating this motorcycle safely is an important responsibility.

To help you make informed decisions about safety, we have provided operating procedures and other information on safety labels and in this manual. This information alerts you to potential hazards that could hurt you or others.

Of course, it is not practical or possible to warn you about all hazards associated with operating or maintaining a motorcycle. You must use your own good judgment.

You will find important safety information in a variety of forms, including:

- Safety labels on the motorcycle
- Safety Messages preceded by a safety alert symbol  and one of three signal words: DANGER, WARNING, or CAUTION.

These signal words mean:

DANGER

You **WILL** be **KILLED** or **SERIOUSLY HURT** if you don't follow instructions.

WARNING

You **CAN** be **KILLED** or **SERIOUSLY HURT** if you don't follow instructions.

CAUTION

You **CAN** be **HURT** if you don't follow instructions.

Other important information is provided under the following titles:

NOTICE Information to help you avoid damage to your motorcycle, other property, or the environment.

Motorcycle Safety

This section contains important information for safe riding of your motorcycle.
Please read this section carefully.

Safety Guidelines	P. 3
Safety Labels	P. 7
Safety Precautions	P. 9
Riding Precautions	P. 10
Accessories & Modifications	P. 14
Loading	P. 15

Safety Guidelines

Follow these guidelines to enhance your safety:

- Perform all routine and regular inspections specified in this manual.
- Stop the engine and keep sparks and flame away before filling the fuel tank.
- Do not run the engine in enclosed or partly enclosed areas. Carbon monoxide in exhaust gases is toxic and can kill you.

Always Wear a Helmet

It's a proven fact: helmets and protective apparel significantly reduce the number and severity of head and other injuries. So always wear an approved motorcycle helmet and protective apparel. ➤ P. 9

Before Riding

Make sure that you are physically fit, mentally focused and free of alcohol and drugs. Check that you and your passenger are both wearing an approved motorcycle helmet and protective apparel. Instruct your passenger on holding onto the seat strap or your waist, leaning with you in turns, and keeping their feet on the footpegs, even when the motorcycle is stopped.

Take Time to Learn & Practice

Even if you have ridden other motorcycles, practice riding in a safe area to become familiar with how this motorcycle works and handles, and to become accustomed to the motorcycle's size and weight.

Safety Guidelines

We recommend that all riders take a certified course approved by the Motorcycle Safety Foundation (MSF). New riders should start with the basic course, and even experienced riders will find the advanced course beneficial. For information about the MSF training course nearest you, call the national toll-free number: (800) 446-9227.

USA Other riding tips can be found in the You and Your Motorcycle Riding Tips booklet that came with your motorcycle.

Ride Defensively

Always pay attention to other vehicles around you, and do not assume that other drivers see you. Be prepared to stop quickly or perform an evasive maneuver.

Make Yourself Easy to See

Make yourself more visible, especially at night, by wearing bright reflective clothing, positioning yourself so other drivers can see you, signaling before turning or changing lanes, and using your horn when necessary.

Ride within Your Limits

Never ride beyond your personal abilities or faster than conditions warrant. Fatigue and inattention can impair your ability to use good judgment and ride safely.

Don't Drink and Ride

Alcohol and riding don't mix. Even one alcoholic drink can reduce your ability to respond to changing conditions, and your reaction time gets worse with every additional drink. Don't drink and ride, and don't let your friends drink and ride either.

Keep Your Honda in Safe Condition

It's important to keep your motorcycle properly maintained and in safe riding condition. Inspect your motorcycle before every ride and perform all recommended maintenance. Never exceed load limits (➤ P. 15), and do not modify your motorcycle or install accessories that would make your motorcycle unsafe (➤ P. 14).

If You are Involved in a Crash

Personal safety is your first priority. If you or anyone else has been injured, take time to assess the severity of the injuries and whether it is safe to continue riding. Call for emergency assistance if needed. Also follow applicable laws and regulations if another person or vehicle is involved in the crash.

If you decide to continue riding, first turn the ignition switch to the OFF position, and evaluate the condition of your motorcycle. Inspect for fluid leaks, check the tightness of critical nuts and bolts, and check the handlebar, control levers, brakes, and wheels. Ride slowly and cautiously.

Your motorcycle may have suffered damage that is not immediately apparent. Have your motorcycle thoroughly checked at a qualified service facility as soon as possible.

Carbon Monoxide Hazard

Exhaust contains poisonous carbon monoxide, a colorless, odorless gas. Breathing carbon monoxide can cause loss of consciousness and may lead to death.

If you run the engine in confined or even partly enclosed area, the air you breathe could contain a dangerous amount of carbon monoxide.

Never run your motorcycle inside a garage or other enclosure.

WARNING

Running the engine of your motorcycle while in an enclosed or even partially enclosed area can cause a rapid build-up of toxic carbon monoxide gas.

Breathing this colorless, odorless gas can quickly cause unconsciousness and lead to death.

Only run your motorcycle's engine when it is located in a well ventilated area outdoors.

Safety Labels

Safety and information labels on your motorcycle provide important safety information and may warn you of potential

hazards that could cause serious injury. Read these labels carefully and don't remove them. If a label comes off or becomes hard to read, contact your dealer for a replacement.

For your protection, always wear your helmet while riding.
Read the owner's manual carefully.

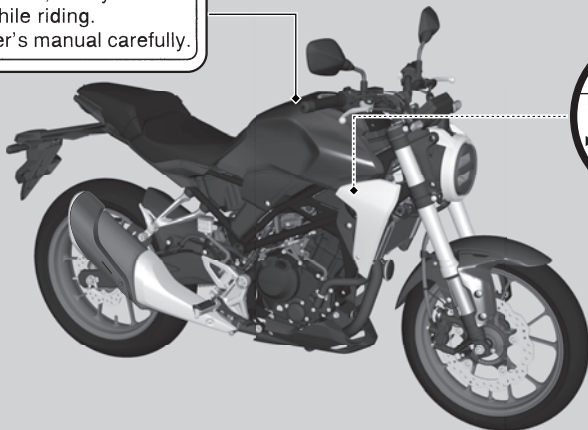

⚠ WARNING

Improper loading can cause a crash and you may be seriously hurt or killed. See "Load Limits and Guidelines" in your Owner's Manual for complete instructions.



TIRE INFORMATION

Cold tire pressures		kPa	kgf/cm ²	psi
Up to maximum weight capacity	Front	200	2.00	29
	Rear	225	2.25	33
Up to 90kg(200lbs) load	Front	200	2.00	29
	Rear	225	2.25	33
Tire size	Front	110/70R17M/C 54H		
	Rear	150/60R17M/C 66H		
Minimum recommend tire center tread depth,	Front	1.5mm (0.06in.)		
	Rear	2.0mm (0.08in.)		
Maximum weight capacity	150kg(331lbs)			

DRIVE CHAIN

Keep chain adjusted and lubricated.
35 mm (1 3/8 in.) Freeplay



Read owner's manual.

Safety Precautions

- Ride cautiously and keep your hands on the handlebar and feet on the footpegs.
- Keep passenger's hands onto the seat strap or your waist, passenger's feet on the footpegs while riding.
- Always consider the safety of your passenger, as well as other drivers and riders.

Protective Apparel

Make sure that you and any passenger are wearing an approved motorcycle helmet, eye protection, and high-visibility protective clothing. Ride defensively in response to weather and road conditions.

Helmet

Should be safety-standard certified, high-visibility, and correct size for your head

- Must fit comfortably but securely, with the chin strap fastened.

- Face shield with unobstructed field of vision or other approved eye protection

USA Look for a DOT (Department of Transportation) certification label on any helmet you buy.

WARNING

Not wearing a helmet increases the chance of serious injury or death in a crash.

Make sure that you and any passenger always wear an approved helmet and protective apparel.

Gloves

Full-finger leather gloves with high abrasion resistance

Riding Precautions

■ Boots or Riding Shoes

Sturdy boots with non-slip soles and ankle protection

■ Jacket and Pants

Protective, highly visible, long-sleeved jacket and durable long pants for riding (or a protective suit)

Riding Precautions

Break-in Period

During the first 300 miles (500 km) of running, follow these guidelines to ensure your motorcycle's future reliability and performance.

- Avoid full-throttle starts and rapid acceleration.
- Avoid hard braking and rapid down-shifts.
- Ride conservatively.

Brakes

Observe the following guidelines:

- Avoid excessively hard braking and downshifting.
 - ▶ Sudden braking can reduce the motorcycle's stability.
 - ▶ Where possible, reduce speed before turning; otherwise you risk sliding out.

- Exercise caution on low traction surfaces.
 - ▶ The tires slip more easily on such surfaces and braking distances are longer.
- Avoid continuous braking.
 - ▶ Repeated braking, such as when descending long, steep slopes can seriously overheat the brakes, reducing their effectiveness. Use engine braking with intermittent use of the brakes to reduce speed.
- For full braking effectiveness, operate both the front and rear brakes together.

Anti-lock Brake System (ABS)

CB300RA only

This model is equipped with an Anti-lock Brake System (ABS) designed to help prevent the brakes from locking up during hard braking. The ABS functions with information provided by the IMU (Inertia Measurement Unit).

- ABS does not reduce braking distance. In certain circumstances, ABS may result in a longer stopping distance.
- ABS does not function at speeds below 6 mph (10 km/h).
- The brake lever and pedal may recoil slightly when applying the brakes. This is normal.
- Always use the recommended front/rear tires and sprockets to ensure correct ABS operation.

■ Engine Braking

Engine braking helps slow your motorcycle down when you release the throttle. For further slowing action, downshift to a lower gear. Use engine braking with intermittent use of the brakes to reduce speed when descending long, steep slopes.

■ Wet or Rainy Conditions

Road surfaces are slippery when wet, and wet brakes further reduce braking efficiency.

Exercise extra caution when braking in wet conditions.

If the brakes get wet, apply the brakes while riding at low speed to help them dry.

Parking

- Park on a firm, level surface.
- If you must park on a slight incline or loose surface, park so that the motorcycle cannot move or fall over.
- Make sure that high-temperature parts cannot come into contact with flammable materials.
- Do not touch the engine, muffler, brakes and other high-temperature parts until they cool down.
- To reduce the likelihood of theft, always lock the handlebar and remove the key when leaving the motorcycle unattended. Use of an anti-theft device is also recommended.

■ Parking with the Side Stand

1. Stop the engine.
2. Push the side stand down.
3. Slowly lean the motorcycle to the left until its weight rests on the side stand.

4. Turn the handlebar fully to the left.
 - ▶ Turning the handlebar to the right reduces stability and may cause the motorcycle to fall.
5. Turn the ignition switch to the LOCK position and remove the key. ➤ P. 43

Refueling and Fuel Guidelines

Follow these guidelines to protect the engine, fuel system and catalytic converter:

- Use only unleaded gasoline.
- Use recommended octane number. Using lower octane gasoline will result in decreased engine performance.
- Do not use fuels containing a high concentration of alcohol. ➤ P. 140
- Do not use stale or contaminated gasoline or an oil/gasoline mixture.
- Avoid getting dirt or water in the fuel tank.

Accessories & Modifications

We strongly advise that you do not add any accessories that were not specifically designed or approved for your motorcycle by Honda or make modifications to your motorcycle from its original design. Doing so can make it unsafe. Modifying your motorcycle may also void your warranty and make your motorcycle illegal to operate on public roads and highways. Before deciding to install accessories on your motorcycle be certain the modification is safe and legal.

⚠️ WARNING

Improper accessories or modifications can cause a crash in which you can be seriously hurt or killed.

Follow all instructions in this owner's manual regarding accessories and modifications.

Do not pull a trailer with, or attach a sidecar to, your motorcycle. Your motorcycle was not designed for these attachments, and their use can seriously impair your motorcycle's handling.

Loading

- Carrying extra weight affects your motorcycle's handling, braking and stability. Always ride at a safe speed for the load you are carrying.
- Avoid carrying an excessive load and keep within specified load limits.
Maximum weight capacity  P. 147
- Tie all luggage securely, evenly balanced and close to the center of the motorcycle.
- Do not place objects near the lights or the muffler.

WARNING

Overloading or improper loading can cause a crash and you can be seriously hurt or killed.

Follow all load limits and other loading guidelines in this manual.

Parts Location

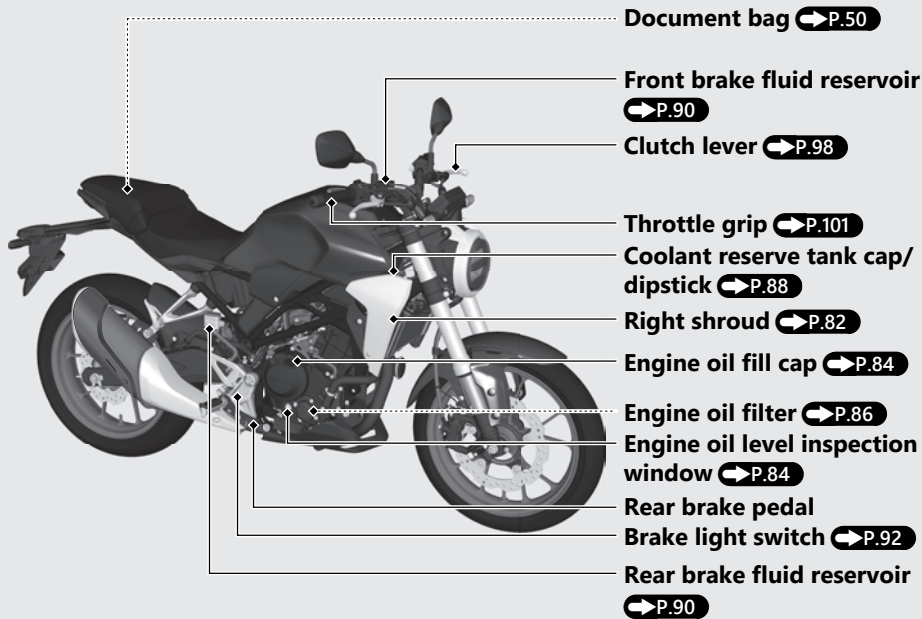

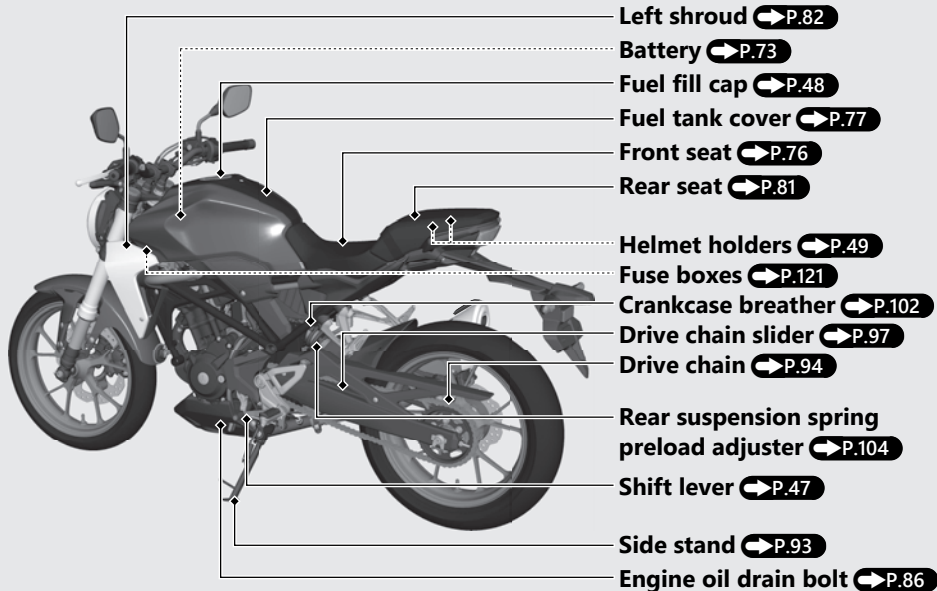

Instruments

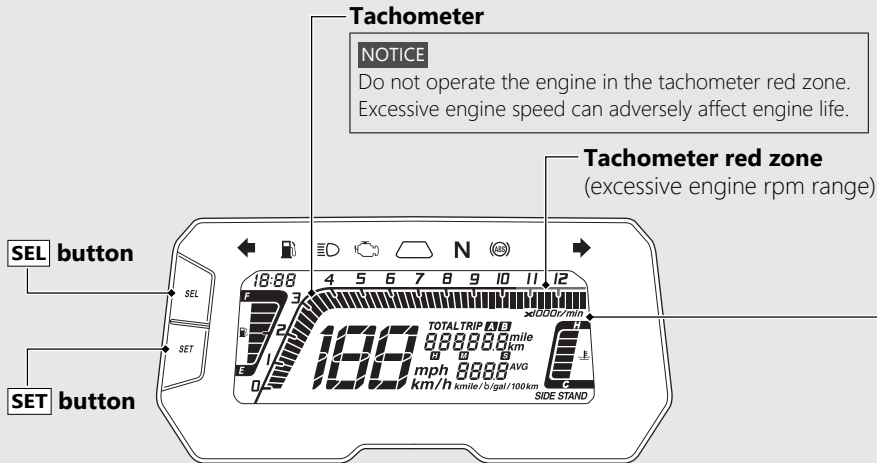

Display Check

When the ignition switch is turned to the ON position, all the mode and digital segments will show. If any part of these displays does not come on when it should, have your dealer check for problems.

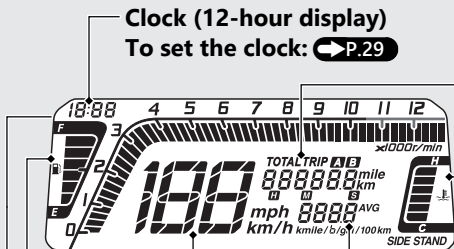

Clock (12-hour display)

To set the clock: **➔P.29**

Odometer [TOTAL] & Tripmeter [TRIP A/B] & Stopwatch **➔P.20**

Coolant temperature gauge ()

When the coolant is over specified temperature, the segment H flashes.

If the segment H flashes while riding: **➔P.107**

Speedometer

Current fuel mileage, Average fuel mileage [AVG], Fuel consumption, and Average speed [AVG] **➔P.24**

Fuel gauge

Remaining fuel when only 1st (E) segment starts flashing: approximately 0.50 US gal (1.9 L)

If the fuel gauge indicator flashes in a repeat pattern or turns off: **➔P.110**



Instruments *(Continued)*

Odometer [TOTAL] & Tripmeter [TRIP A/B] & Stopwatch

The **SEL** button switches between the odometer, tripmeter A, tripmeter B, and stopwatch.

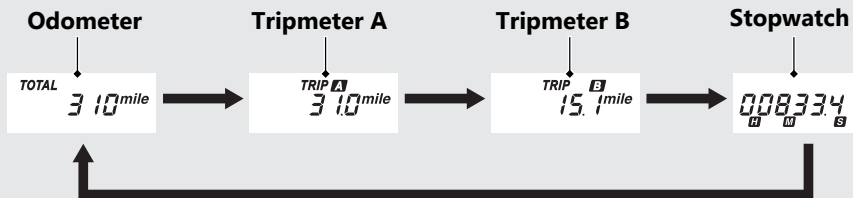

▮ Odometer [TOTAL]

Total distance ridden. When " - - - - - " is displayed, go to your dealer for service.

▮ Tripmeter [TRIP A/B]

Distance ridden since tripmeter was reset. When " - - - - . - " is displayed, go to your dealer for service.

To reset the tripmeter: ➡ P.22

▮ Stopwatch

Shows elapsed time since the **SET** button was pushed to start the measurement.

Display range:

0H00M00.0S - 9H59M59.9S

- Above 9H59M59.9S back to 0H00M00.0S

To use the stopwatch: ➡ P.23

Instruments (Continued)

To reset the tripmeter [TRIP A/B], average fuel mileage [AVG], fuel consumption and average speed [AVG]

To reset the tripmeter A, average fuel mileage A, fuel consumption A and average speed A (these are based on tripmeter A) together, press and hold the **[SEL]** button while tripmeter A is displayed.

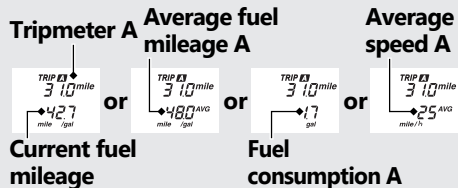

When they are reset, reset display appears at each indication. Then, the display returns to the last selected indication.



To reset the tripmeter B, average fuel mileage B, fuel consumption B and average speed B (these are based on tripmeter B) together, press and hold the **[SEL]** button while tripmeter B is displayed.

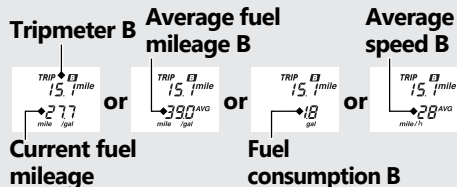

When they are reset, reset display appears at each indication. Then, the display returns to the last selected indication.



Stopwatch

To Measure the Time

- 1 Select the stopwatch. P.20
- 2 To start measurement, press the **SET** button.
 - ▶ The measurement keeps going, if you change an item while measuring.
- 3 To finish measurement, press the **SET** button.
 - ▶ The measurement can also be finished by turning the ignition switch to the OFF position.

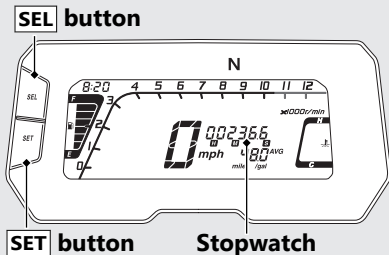

To Restart the Measurement

Press the **SET** button again. The stopwatch restarts measurement.

To Reset the Measured Value

Press and hold the **SEL** button when the stopwatch is displayed and also the measurement is finished.

Instruments *(Continued)*

Current fuel mileage, Average fuel mileage [AVG], Fuel consumption, and Average speed [AVG]

The **SET** button switches between the current fuel mileage, average fuel mileage, fuel consumption and average speed.

- ▶ The items cannot be switched by the **SET** button if the stopwatch is displayed.

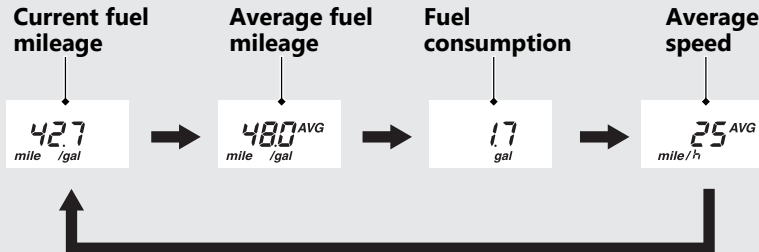

Current fuel mileage

Displays the current instant fuel mileage.

Display range:

USA model 0.0 to 299.9 mile/gal (L/100km or km/L)

Canada model 0.0 to 299.9 L/100km (km/L, mile/gal or mile/L)

- **USA model** More than 299.9 mile/gal (L/100km or km/L): "299.9" is displayed.
- **Canada model** More than 299.9 L/100km (km/L, mile/gal or mile/L): "299.9" is displayed.
- When your speed is less than 4 mph (6 km/h): "----" is displayed.

When "----" is displayed except for the above-mentioned cases, go to your dealer for service.

Average fuel mileage [AVG]

Displays the average fuel mileage since the selected tripmeter was reset.

The average fuel mileage will be calculated based on value displayed on the tripmeter (A or B) selected.

Also, the average fuel mileage for tripmeter A will be displayed when the odometer, tripmeter A, and stopwatch are selected.

Display range:

USA model 0.0 to 299.9 mile/gal (L/100km or km/L)

Canada model 0.0 to 299.9 L/100km (km/L, mile/gal or mile/L)

- **USA model** More than 299.9 mile/gal (L/100km or km/L): "299.9" is displayed.
- **Canada model** More than 299.9 L/100km (km/L, mile/gal or mile/L): "299.9" is displayed.

Instruments *(Continued)*

- When the tripmeter A or B is reset: "----" is displayed.

When "----" is displayed except for the above-mentioned cases, go to your dealer for service.

To reset the average fuel mileage:

➔ P.22

Fuel consumption

Displays the fuel consumption since the selected tripmeter was reset.

The fuel consumption will be calculated based on value displayed on the tripmeter (A or B) selected.

Also, the fuel consumption for tripmeter A will be displayed when the odometer, tripmeter A, and stopwatch are selected.

Display range: 0.0 to 299.9 gal (gallon) or 0.0 to 299.9 L (liters)

- More than 299.9 gal (gallon) or 299.9 L (liters): "299.9" is displayed.

When "----" is displayed, go to your dealer for service.

To reset the fuel consumption: ➔ P.22

Average speed

Displays the average speed since the selected tripmeter was reset.

The average speed will be calculated based on value displayed on the tripmeter (A or B) selected.

Also, the average speed for tripmeter A will be displayed when the odometer, tripmeter A, and stopwatch are selected.

Display range: 0 to 124 mile/h (0 to 199 km/h)

- Initial display: "---" is displayed.
- When your motorcycle has traveled less than 0.12 mile (0.2 km) since the engine was started: "---" is displayed.
- When your motorcycle operating time is less than 30 seconds since the engine was started: "---" is displayed.

When "---" is displayed except for the above-mentioned cases, go to your dealer for service.

To reset the average speed:  **P.22**

Instruments *(Continued)*

Display Setting

Setting Mode A

Following items can be changed sequentially.  **P.29**

- Clock setting
- Backlight brightness adjustment
- Changing the speed and mileage unit
- Changing the fuel mileage meter unit

Setting Mode B

Following items can be changed sequentially.  **P.33**

- Setting of REV indicator
(lighting RPM setting, lighting interval RPM setting, and brightness adjustment)
- Changing of tachometer display mode

Setting Mode A

If the buttons are not pressed for about 30 seconds, the control is automatically switched from the setting mode to the ordinary display.

If the buttons are not pressed for about 30 seconds, items in the process of being set will be discarded and only items that were set and finalized will be applied. Only if the ignition switch is turned to the OFF position, items in the process of being set and those that are finalized will be applied.

1 Clock setting:

- 1 Turn the ignition switch to the ON position.
- 2 Select the odometer, tripmeter A or tripmeter B.  P.20
- 3 Press and hold **SEL** and **SET** buttons until the hour digits start flashing.



- 4 Press **SEL** button until the desired hour is displayed.
 - ▶ Press and hold **SEL** button to advance the hour quickly.



Instruments (Continued)

- 5 Press **SET** button. The minute digits start flashing.



- 6 Press **SEL** button until the desired minute is displayed.
 ▶ Press and hold **SEL** button to advance the minute quickly.



- 7 Press **SET** button. The clock is set, and then the display moves to the backlight brightness adjustment.

2 Backlight brightness adjustment:

You can adjust the brightness to one of five levels.

- 1 Press **SEL** button. The brightness is switched.



- 2 Press **SET** button. The backlight is set, and then the display moves to the changing the speed and mileage unit. The speed and mileage unit will start flashing.

3 Changing the speed and mileage unit:

- 1 Press **SEL** button to select either "mph" and "mile" or "km/h" and "km".



USA model

When selecting the "mph" and "mile", the fuel mileage unit shows only "mile/gal" and the unit of the fuel consumption is changed to "gal".

Canada model

When selecting the "mph" and "mile", the fuel mileage unit can be selected "mile/L" or "mile/gal".

- 2 When selecting the "mph" and "mile" in USA model

Press **SET** button. The speed and mileage unit is set, and then the display moves to the ordinary display.

When selecting the "km/h" and "km" in all models or "mph" and "mile" in Canada model

Press **SET** button. The speed and mileage unit is set, and then the display moves to the changing the fuel mileage meter unit.

Instruments *(Continued)*

4 Changing the fuel mileage meter unit:

- 1 When the "mph" for speed and "mile" for mileage are selected

Press **SEL** button to select "mile/L" or "mile/gal".

▶ When "mile/gal" is selected, the unit of the fuel consumption is changed to "gal".

When the "km/h" for speed and "km" for mileage are selected

Press **SEL** button to select "km/L" or "L/100km".

- 2 Press **SET** button. The fuel mileage meter unit is set, and then the display moves to the ordinary display.

Setting Mode B

If the buttons are not pressed for about 30 seconds, the control is automatically switched from the setting mode to the ordinary display.

If the buttons are not pressed for about 30 seconds, items in the process of being set will be discarded and only items that were set and finalized will be applied. Only if the ignition switch is turned to the OFF position, items in the process of being set and those that are finalized will be applied.

1 Setting of REV indicator:

You can change the setting of the REV indicator.

REV indicator blinks when setting.

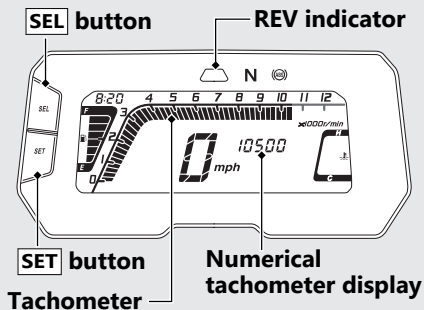

Instruments *(Continued)*

- ① To change the setting mode B, turn the ignition switch to the ON position while pressing **SEL** button until the display check is finished. The blinking bar segments in the tachometer shows the current REV indicator lighting RPM and the current numerical tachometer setting is displayed.
 - ▶ Tachometer bar segment is displayed as a conventional display, regardless of set up display method.
- ② Each time **SEL** button is pressed, the lighting RPM set value increase by 250 r/min (rpm) (one segment). When the lighting RPM set value exceeds the allowable range, the lighting RPM set value automatically returns to 4,000 r/min (rpm).
 - ▶ Press and hold **SEL** button to advance the lighting RPM set value quickly.

Available Setting Range

4,000 -to- 10,500 r/min (rpm)

- 3 Press **SET** button. The REV indicator lighting RPM is set, and the display moves to the setting of REV indicator lighting interval RPM.

At the same time, the blinking bar segment shows the current settings of the REV indicator lighting RPM and the numerical tachometer display shows the current REV indicator lighting interval RPM.

- 4 Each time **SEL** button is pressed, the numbers of the REV indicator lighting interval RPM advances in this order: 0 r/min (rpm), 250 r/min (rpm), and 500 r/min (rpm).

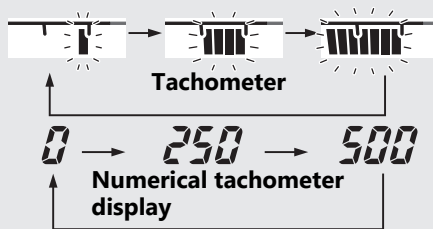

Instruments (Continued)

Example: When REV indicator lighting RPM setting is 10,000 r/min (rpm) and REV indicator lighting interval RPM is 250 r/min (rpm).

REV indicator	r/min (rpm)
Blinks (2 times/second)	9,250 r/min (rpm)
Blinks (5 times/second)	9,500 r/min (rpm)
Blinks (10 times/second)	9,750 r/min (rpm)
Solid light	10,000 r/min (rpm)

If the REV indicator lighting interval RPM is set to 0, the REV indicator comes on when reaching the lighting RPM set value.

- Press **SET** button. The REV indicator lighting interval RPM is set, and the display moves to the brightness adjustment of the REV indicator.

The REV indicator switches from blinking light to a solid light.

- Press **SEL** button. The brightness is switched.

▶ You can adjust the brightness to one of five levels.



- Press **SET** button. The brightness of the REV indicator is set, and the display moves to the display setting of the tachometer.

2 Changing of tachometer display mode:

You can change the display mode of the tachometer.

- ① Press **SEL** button to switch the display mode of tachometer.
- ② Press **SET** button. The currently selected display mode is set, and then the display moves to the ordinary display.

Conventional display

Shows the engine RPM on the tachometer bar segment.

Peak hold display

Shows the engine RPM on the tachometer bar segment and peak hold segment. The peak hold segment keeps to show the maximum engine RPM temporarily.

Ex Engine revolutions per minutes
10,500 r/min (rpm)

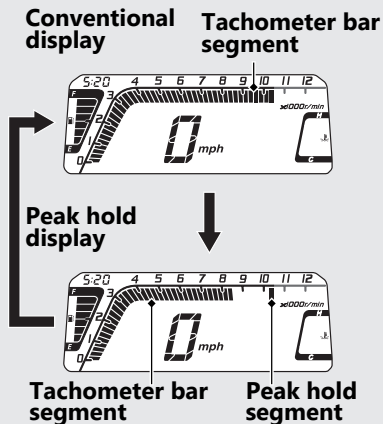

Indicators

If one of these indicators does not come on when it should, have your dealer check for problems.

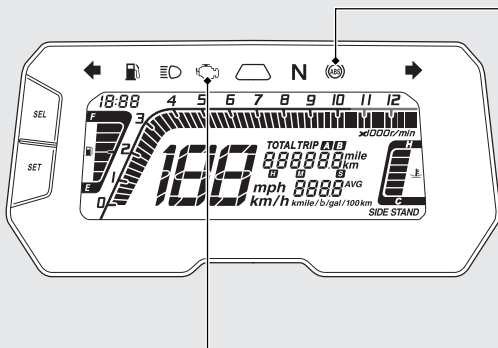

ABS (Anti-lock Brake System) indicator **CB300RA only**

Comes on when the ignition switch is turned to the ON position. Goes off when your speed reaches approximately 6 mph (10 km/h).

If it comes on while riding:

 **P.109**

PGM-FI (Programmed Fuel Injection) malfunction indicator lamp (MIL)

Comes on briefly when the ignition switch is turned to the ON position with the engine stop switch in the  (Run) position.

If it comes on while engine is running:

 **P.108**

REV indicator



High beam indicator



Left turn signal indicator



N Neutral indicator

Comes on when the transmission is in Neutral.

Right turn signal indicator

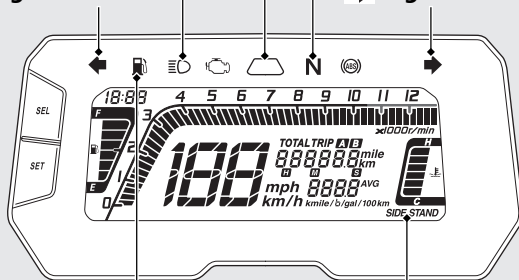

Low fuel indicator

Comes on when there is only reserve fuel left in the fuel tank. Remaining fuel when low fuel indicator comes on: 0.50 US gal (1.9 L)

SIDE STAND indicator

Comes on when the side stand is lowered.

Indicators *(Continued)*

REV Indicator

- Comes on briefly when the ignition switch is turned to the ON position.

Initial setting

Lighting RPM: 8,000 r/min (rpm)

Interval RPM: 250 r/min (rpm)



REV indicator	r/min (rpm)
Blinks (2 times/second)	7,250 r/min (rpm)
Blinks (5 times/second)	7,500 r/min (rpm)
Blinks (10 times/second)	7,750 r/min (rpm)
Solid light	8,000 r/min (rpm)

▶ Setting of REV indicator:  **P.33**

BLANK PAGE

Switches

Headlight dimmer switch

-  : High beam
-  : Low beam



Horn button



Turn signal switch

- ▶ Pressing the switch turns the turn signal off.



PASS Passing light control switch

Flashes the high beam headlight.



Start button

Engine stop switch

Should normally remain in the  (Run) position.

- ▶ In an emergency, switch to the  (Stop) position (the starter motor will not operate) to stop the engine.

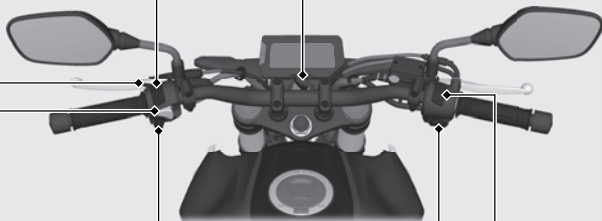

Ignition switch

Switches the electrical system on/off, locks the steering.

- ▶ Key can be removed when in the OFF or LOCK position.

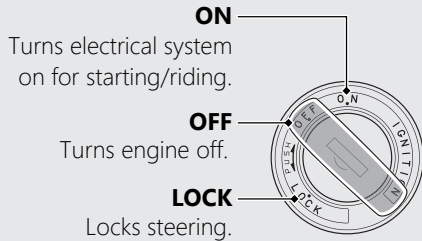

Switches *(Continued)*

Steering Lock

Lock the steering when parking to help prevent theft.

A U-shaped wheel lock or similar device is also recommended.

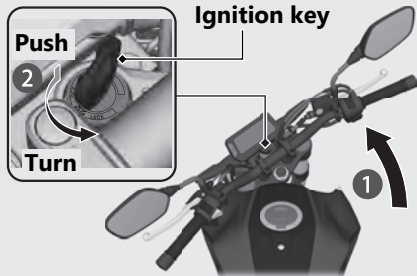

Locking

- 1 Turn the handlebar all the way to the left.
- 2 Push the ignition key down, and turn the ignition switch to the LOCK position.
 - ▶ Jiggle the handlebar if the lock is difficult to engage.
- 3 Remove the ignition key.

Unlocking

Insert the key, push it in, and turn the ignition switch to the OFF position.

Starting the Engine

Start your engine using the following procedure, regardless of whether the engine is cold or warm.

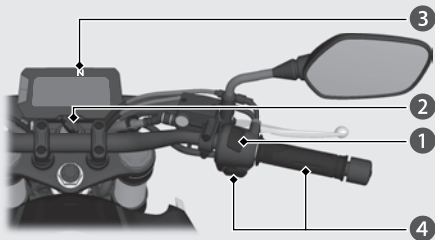

NOTICE

- If the engine does not start within 5 seconds, turn the ignition switch to the OFF position and wait 10 seconds before trying to start the engine again to recover battery voltage.
- Extended fast idling and revving the engine can damage the engine, and the exhaust system.

- 1 Make sure the engine stop switch is in the  (Run) position.
- 2 Turn the ignition switch to the ON position.
- 3 Shift the transmission to Neutral (**N** indicator to come on). Alternatively, pull in the clutch lever to start your motorcycle with the transmission in gear so long as the side stand is raised.
- 4 With the throttle completely closed, press the start button.
 - ▶ If you cannot start the engine, open the throttle slightly (about 1/8 in (3 mm), without freeplay) and press the start button.

About 1/8 in (3 mm), without freeplay

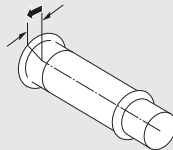

Starting the Engine *(Continued)*

If the engine does not start:

- ① Open the throttle fully and press the start button for 5 seconds.
- ② Repeat the normal starting procedure.
- ③ If the engine starts, open the throttle slightly if idling is unstable.
- ④ If the engine does not start, wait 10 seconds before trying step ① & ② again.

If Engine Will Not Start P.106

Shifting Gears

Your motorcycle transmission has 6 forward gears in a one-down, five-up shift pattern.

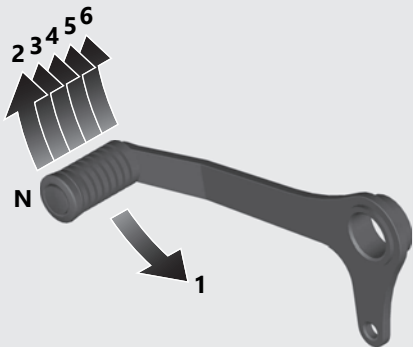

If you put the motorcycle in gear with the side stand down, the engine will shut off.

Recommended Shift Points

Shifting Up

From 1st to 2nd	12 mph (20 km/h)
From 2nd to 3rd	19 mph (30 km/h)
From 3rd to 4th	25 mph (40 km/h)
From 4th to 5th	31 mph (50 km/h)
From 5th to 6th	37 mph (60 km/h)

Shifting Down

From 6th to 5th	28 mph (45 km/h)
From 5th to 4th	22 mph (35 km/h)
From 4th to 3rd	16 mph (25 km/h)

NOTICE

Improper shifting can damage the engine, transmission, and drive train. Also, coasting or towing the motorcycle for long distances with the engine off can damage the transmission.

Refueling

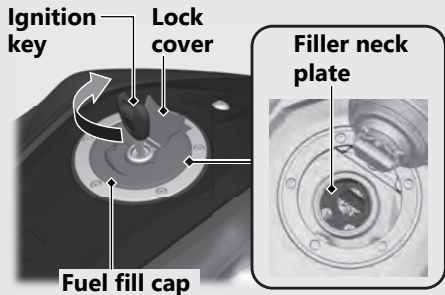

Do not fill with fuel above the filler neck plate.

Fuel type: Unleaded gasoline only

Recommended fuel octane number:

Pump Octane Number (PON) 86 or higher.

Tank capacity: 2.67 US gal (10.1 L)

Refueling and Fuel Guidelines ➔ P.13

Opening the Fuel Fill Cap

Open the lock cover, insert the ignition key, and turn it clockwise to open the fuel fill cap.

Closing the Fuel Fill Cap

- 1 After refueling, push the fuel fill cap closed until it locks.
- 2 Remove the ignition key and close the lock cover.
 - ▶ The ignition key cannot be removed if the fuel fill cap is not locked.

⚠WARNING

Gasoline is highly flammable and explosive. You can be burned or seriously injured when handling fuel.

- Stop the engine, and keep heat, sparks, and flame away.
- Handle fuel only outdoors.
- Wipe up spills immediately.

Storage Equipment

Helmet Holder

The helmet holders are located under the rear seat.

Helmet holders

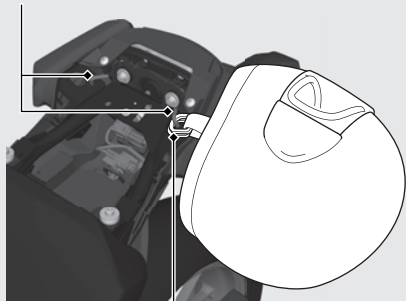

Helmet D-ring

► Use the helmet holder only when parked.

► **Removing the Rear Seat** ➔ P.81

⚠WARNING

Riding with a helmet attached to the holder can interfere with your ability to safely operate the motorcycle and could lead to a crash in which you can be seriously hurt or killed.

Use the helmet holder only while parked. Do not ride with a helmet secured by the holder.

Storage Equipment *(Continued)*

Document Bag

The document bag are located underside of the rear seat by the rubber strap.

The 5 mm Hex wrench is stored in the document bag.

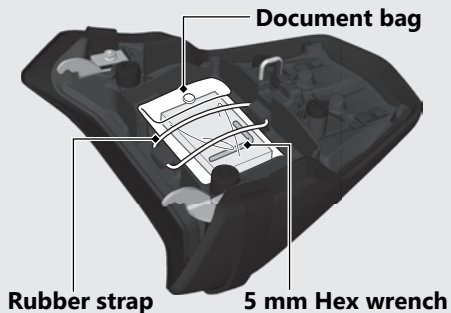

Removing the Rear Seat ➔ P.81

Maintenance

Please read "Importance of Maintenance" and "Maintenance Fundamentals" carefully before attempting any maintenance. Refer to "Specifications" for service data.

An optional larger tool kit may be available.
Check with your Honda dealer's parts department.

Importance of Maintenance	P. 52	Brakes	P. 90
Maintenance Schedule	P. 54	Side Stand	P. 93
Maintenance Record	P. 57	Drive Chain	P. 94
Maintenance Fundamentals	P. 58	Clutch	P. 98
Removing & Installing Body Components ..	P. 73	Throttle	P. 101
Battery	P. 73	Crankcase Breather	P. 102
Clip	P. 75	Other Adjustments	P. 103
Front Seat	P. 76	Adjusting the Headlight Aim	P. 103
Fuel Tank Cover Assembly	P. 77	Adjusting the Rear Suspension.....	P. 104
Fuel Tank Maintenance Position.....	P. 79		
Rear Seat	P. 81		
Shroud.....	P. 82		
Engine Oil	P. 84		
Coolant	P. 88		

Importance of Maintenance

Importance of Maintenance

Keeping your motorcycle well-maintained is absolutely essential to your safety and to protect your investment, obtain maximum performance, avoid breakdowns, and reduce air pollution. Maintenance is the owner's responsibility. Be sure to inspect your motorcycle before each ride, and perform the periodic checks specified in the Maintenance Schedule. ➤ P. 54

⚠ WARNING

Improperly maintaining your motorcycle or failing to correct a problem before you ride can cause a crash in which you can be seriously hurt or killed.

Always follow the inspection and maintenance recommendations and schedules in this owner's manual.

For information about the exhaust emission and noise emission requirements of the U.S. Environmental Protection Agency (EPA), the California Air Resources Board (CARB), and the Environment and Climate Change Canada (ECCC). ➤ P. 134

USA

Maintenance, replacement or repair of the emission control devices and systems may be performed by any motorcycle repair establishment or individual using parts that are "certified" to EPA standards.

Maintenance Safety

Always read the maintenance instructions before you begin each task, and make sure that you have the tools, parts, and skills required. We cannot warn you of every conceivable hazard that can arise in performing maintenance. Only you can decide whether or not you should perform a given task.

Follow these guidelines when performing maintenance.

- Stop the engine and remove the key.
- Place your motorcycle on a firm, level surface using the side stand or a maintenance stand to provide support.
- Allow the engine, muffler, brakes, and other high-temperature parts to cool before servicing as you can get burned.
- Run the engine only when instructed, and do so in a well-ventilated area.

Maintenance Schedule

The maintenance schedule specifies the maintenance requirements necessary to ensure safe, dependable performance, and proper emission control.

Maintenance work should be performed in accordance with Honda's standards and specifications by properly trained and equipped technicians. Your dealer meets all of these requirements. All scheduled maintenance is considered a normal owner operating cost and will be charged to you by your dealer. Keeping an accurate maintenance record will help ensure your motorcycle is properly maintained.

➤ P. 57

Make sure whoever performs the scheduled maintenance completes the maintenance record. Retain all service documents. If you sell your motorcycle, these service documents should be transferred with the motorcycle to the new owner.

Items		Frequency *1								Regular Replace	Refer to page	
		× 1,000 mi	0.6	4	8	12	16	20	24			
		× 1,000 km	1.0	6.4	12.8	19.2	25.6	32.0	38.4			
Emission-Related Items	Fuel Line	↗			I		I		I		-	
	Throttle Operation	↗			I		I		I		101	
	Air Cleaner *2					R			R		72	
	Crankcase Breather *3			C	C	C	C	C	C		102	
	Spark Plug		Every 16,000 mi (25,600 km): I				Every 32,000 mi (51,200 km): R					-
	Valve Clearance	↗					I				-	
	Engine Oil		R		R		R		R	1 Year	84	
	Engine Oil Filter		R				R				86	
	Engine Idle Speed	↗			I		I		I		-	
	Radiator Coolant *5				I		I		I	3 Years	88	
	Cooling System	↗			I		I		I		-	
Secondary Air Supply System	↗					I				-		
Evaporative Emission Control System *4	↗					I				-		

















































Maintenance Level

- ↗ : Intermediate. We recommend service by your dealer, unless you have the necessary tools and are mechanically skilled. Procedures are provided in an official Honda Service Manual (➡ P. 141).
- ✂ : Technical. In the interest of safety, have your motorcycle serviced by your dealer.

Maintenance Legend

- I : Inspect (clean, adjust, lubricate, or replace, if necessary)
- C : Clean
- R : Replace
- L : Lubricate

Maintenance Schedule

Items		Frequency *1								Regular Replace	Refer to page
		× 1,000 mi	0.6	4	8	12	16	20	24		
		× 1,000 km	1.0	6.4	12.8	19.2	25.6	32.0	38.4		
Non-Emission-Related Items	Drive Chain	Every 600 mi (1,000 km):  									94
	Brake Fluid *5									2 Years	90
	Brake Pads Wear										91
	Brake System										58
	Brake Light Switch										92
	Headlight Aim										103
	Clutch System										98
	Side Stand										93
	Suspension										104
	Nuts, Bolts, Fasteners										–
Wheels/Tires										68	
Steering Head Bearings										–	

Notes:

*1 : At higher odometer reading, repeat at the frequency interval established here.

*2 : Service more frequently when riding in unusually wet or dusty areas.

*3 : Service more frequently when riding in rain or at full throttle.

*4 : 50 STATE (meets California).

*5 : Replacement requires mechanical skill.

Maintenance Record

Distance	Odometer	Date	Performed By:	Notes
600 miles (1,000 km)				
4,000 miles (6,400 km)				
8,000 miles (12,800 km)				
12,000 miles (19,200 km)				
16,000 miles (25,600 km)				
20,000 miles (32,000 km)				
24,000 miles (38,400 km)				
28,000 miles (44,800 km)				
32,000 miles (51,200 km)				
36,000 miles (57,600 km)				
40,000 miles (64,000 km)				
44,000 miles (70,400 km)				
48,000 miles (76,800 km)				
52,000 miles (83,200 km)				
56,000 miles (89,600 km)				
60,000 miles (96,000 km)				
64,000 miles (102,400 km)				
68,000 miles (108,800 km)				

Pre-ride Inspection

To ensure safety, it is your responsibility to perform a pre-ride inspection and make sure that any problem you find is corrected. A pre-ride inspection is a must, not only for safety, but because having a breakdown, or even a flat tire, can be a major inconvenience.

Check the following items before you get on your motorcycle:

- Tire tread wear and air pressures are within limits. ➔ P. 68
- Lights, horn, and turn signals operate normally.
- Check the condition of the drive chain. Adjust slack and lubricate as needed. ➔ P. 65

Check the following items if you are carrying a passenger or cargo:

- Combined weight is within load limits. ➔ P. 147
- Cargo is secured properly.

- Suspension is adjusted to suit load. ➔ P. 104

Check the following items after you get on your motorcycle:

- Throttle action moves smoothly without binding. ➔ P. 101
- Brake lever and pedal operate normally.
- Check the fuel level and refuel when needed. ➔ P. 13, ➔ P. 48
- Engine stop switch functions properly. ➔ P. 42

Check the following items at regular intervals:

- Oil level is between the upper and lower level marks. ➔ P. 84
- Brake fluid level is
Front: above the LWR level mark. ➔ P. 90
Rear: between the UPPER and LOWER level marks. ➔ P. 90
- Engine coolant level is between the upper and lower level marks. ➔ P. 88
- Side stand functions properly. ➔ P. 93

Periodic Checks

You should also perform other periodic maintenance checks at least once a month regardless of how often you ride, or more often if you ride frequently.

Also, check the odometer reading against the Maintenance Schedule and perform all maintenance that is due. ➤ P. 54

Tires and wheels	Check the air pressure (➤ P. 68), examine tread for wear and damage (➤ P. 68), and check the wheels for damage.
Fluid levels	Check the engine oil level (➤ P. 84), engine coolant level (➤ P. 88), and brake fluid level (➤ P. 90).
Lights	Check that the headlight, brake light, taillight, turn signals and license plate light are working properly.
Controls	Check the freeplay of the clutch lever (➤ P. 98), and throttle grip (➤ P. 101).
Drive chain	Check the slack (➤ P. 94), adjust the slack (➤ P. 95), and lubricate (➤ P. 66) as needed.
Fuses	Check that you have a full supply of spare fuses.
Nuts & bolts	Check the major nuts and bolts, and tighten as needed.

Replacing Parts

Always use Honda Genuine Parts or their equivalents to ensure reliability and safety. When ordering colored components, specify the model name, color, and code mentioned on the color label.

The color label is attached to the rear fender under the rear seat. ➤ P. 81

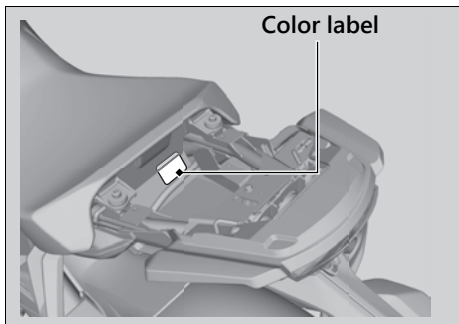

⚠️ WARNING

Installing non-Honda parts may make your motorcycle unsafe and cause a crash in which you can be seriously hurt or killed.

Always use Honda Genuine Parts or equivalents that have been designed and approved for your motorcycle.

Battery

Your motorcycle has a maintenance-free type battery. You do not have to check the battery electrolyte level or add distilled water. Clean the battery terminals if they become dirty or corroded.

Do not remove the battery cap seals. There is no need to remove the cap when charging.

NOTICE

An improperly disposed of battery can be harmful to the environment and human health. Always confirm local regulations for proper battery disposal instruction.

What to do in an emergency

If any of the following occur, immediately see your doctor.

- Electrolyte splashes into your eyes:
 - ▶ Wash your eyes repeatedly with cool water for at least 15 minutes. Using water under pressure can damage your eyes.

- Electrolyte splashes onto your skin:
 - ▶ Remove affected clothing and wash your skin thoroughly using water.
- Electrolyte splashes into your mouth:
 - ▶ Rinse mouth thoroughly with water, and do not swallow.

⚠ WARNING

The battery gives off explosive hydrogen gas during normal operation.

A spark or flame can cause the battery to explode with enough force to kill or seriously hurt you.

Wear protective clothing and a face shield, or have a skilled mechanic do the battery servicing.

WARNING: Battery posts, terminals, and related accessories contain lead and lead compounds.

Wash your hands after handling.

Cleaning the Battery Terminals

1. Remove the battery. ➤ P. 73
2. If the terminals are starting to corrode and are coated with a white substance, wash with warm water and wipe clean.
3. If the terminals are heavily corroded, clean and polish the terminals with a wire brush or sandpaper. Wear safety glasses.

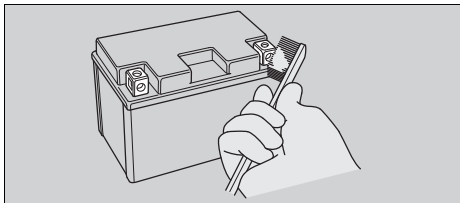

4. After cleaning, reinstall the battery.

The battery has a limited life span. Consult your dealer about when you should replace the battery. Always replace the battery with another maintenance-free battery of the same type.

Charging

If you use electrical accessories that drain the battery or you do not ride frequently, we recommend that you charge the battery every 30 days using a charger designed specifically for your Honda, which can be purchased from your dealer. Read the information that came with your battery charger and follow the instructions on the battery. Avoid using an automobile-type battery charger, as these can overheat a motorcycle battery and cause permanent damage.

Make sure the ignition switch is in the OFF position before charging the battery.

NOTICE

Improper charging can damage the battery. If you can't charge the battery or it appears unable to hold a charge, contact your dealer.

NOTICE

Jump starting using an automobile battery can damage your motorcycle's electrical system and is not recommended. Bump starting is also not recommended.

NOTICE

Installing non-Honda electrical accessories can overload the electrical system, discharging the battery and possibly damaging the system.

Fuses

Fuses protect the electrical circuits on your motorcycle. If something electrical on your motorcycle stops working, check for and replace any blown fuses. ➔ P. 121

Inspecting and Replacing Fuses

Turn the ignition switch to the OFF position to remove and inspect fuses. If a fuse is blown, replace with a fuse of the same rating. For fuse ratings, see "Specifications." ➔ P. 149

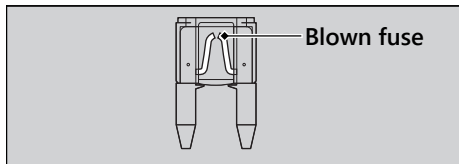
**NOTICE**

Replacing a fuse with one that has a higher rating greatly increases the chance of damage to the electrical system.

If a fuse fails repeatedly, you likely have an electrical fault. Have your motorcycle inspected by your dealer.

Engine Oil

Engine oil consumption varies and oil quality deteriorates according to riding conditions and time elapsed.

Check the engine oil level regularly, and add the recommended engine oil if necessary. Dirty oil or old oil should be changed as soon as possible.

Selecting the Engine Oil

For recommended engine oil, see "Specifications." P. 148

If you use non-Honda engine oil, check the label to make sure that the oil satisfies all of the following standards:

- JASO T 903 standard^{*1}: MA
- SAE standard^{*2}: 10W-30
- API classification^{*3}: SG or higher

- ^{*1}. The JASO T 903 standard is an index for engine oils for 4-stroke motorcycle engines. There are two classes: MA and MB. For example, the following label shows the MA classification.

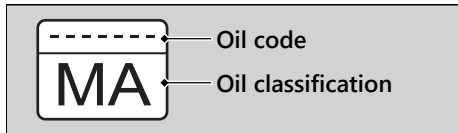

- ^{*2}. The SAE standard grades oils by their viscosity.
- ^{*3}. The API classification specifies the quality and performance rating of engine oils. Use SG or higher oils, excluding oils marked as "Energy Conserving" or "Resource Conserving" on the circular API service symbol.

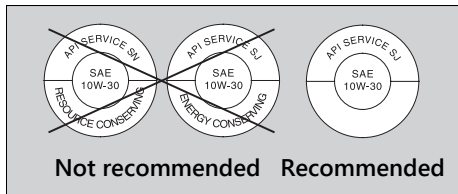

Brake Fluid

Do not add or replace brake fluid, except in an emergency. Use only fresh brake fluid from a sealed container. If you do add fluid, have the brake system serviced by your dealer as soon as possible.

NOTICE

Brake fluid can damage plastic and painted surfaces. Wipe up spills immediately and wash thoroughly.

Recommended brake fluid:

Honda DOT 3 or DOT 4 Brake Fluid or equivalent

WARNING

Clean filler cap before removing. Use only DOT 3 or DOT 4 fluid from a sealed container.

Drive Chain

The drive chain must be inspected and lubricated regularly. Inspect the chain more frequently if you often ride on bad roads, ride at high speed, or ride with repeated fast acceleration.  P. 94

If the chain does not move smoothly, makes strange noises, has damaged rollers, has loose pins, has missing O-rings, or kinks, have the chain inspected by your dealer.

Maintenance Fundamentals

Also inspect the drive sprocket and driven sprocket. If either has worn or damaged teeth, have the sprocket replaced by your dealer.

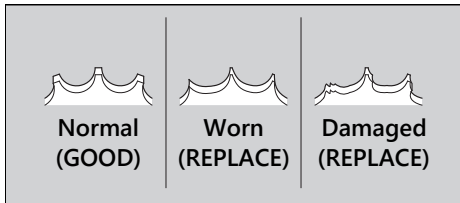

NOTICE

Use of a new chain with worn sprockets will cause rapid chain wear.

Cleaning and Lubricating

After inspecting the slack, clean the chain and sprockets while rotating the rear wheel. Use a dry cloth with chain cleaner designed specifically for O-ring chains, or neutral detergent. Use a soft brush if the chain is dirty. After cleaning, wipe dry and lubricate with the recommended lubricant.

Recommended lubricant:

Pro Honda HP Chain Lube or equivalent

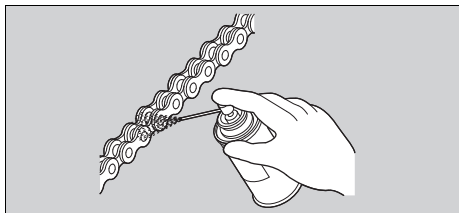

Do not use a steam cleaner, a high pressure cleaner, a wire brush, volatile solvent such as gasoline and benzene, abrasive cleaner, chain cleaner or lubricant NOT designed specifically for O-ring chains as these can damage the rubber O-ring seals.

Avoid getting lubricant on the brakes or tires. Avoid applying excess chain lubricant to prevent spray onto your clothes and the motorcycle.

Recommended Coolant

Pro Honda HP Coolant is a pre-mixed solution of antifreeze and distilled water.

Concentration:

50% antifreeze and 50% distilled water

A concentration of antifreeze below 40% will not provide proper corrosion and cold temperature protection.

A concentration of up to 60% will provide better protection in colder climates.

NOTICE

Using coolant not specified for aluminum engines or tap/mineral water can cause corrosion.

Crankcase Breather

Service more frequently when riding in rain, at full throttle, or after the motorcycle is washed or overturned. Service if the deposit level can be seen in the transparent section of the drain tube.

If the drain tube overflows, the air filter may become contaminated with engine oil causing poor engine performance. ➤ P. 102

Tires (Inspecting/Replacing)

Checking the Air Pressure

Visually inspect your tires and use an air pressure gauge to measure the air pressure at least once a month or any time you think the tires look low. Always check air pressure when your tires are cold.

Inspecting for Damage

Inspect the tires for cuts, slits, or cracks that exposes fabric or cords, or nails or other foreign objects embedded in the side of the tire or the tread.

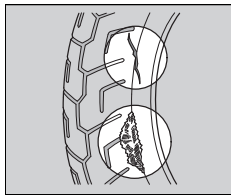

Also inspect for any unusual bumps or bulges in the side walls of the tires.

Inspecting for Abnormal Wear

Inspect the tires for signs of abnormal wear on the contact surface.

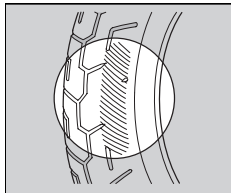

Inspecting Tread Depth

Inspect the tread wear indicators. If they become visible, replace the tires immediately. For safe riding, you should replace the tires when the minimum tread depth is reached.

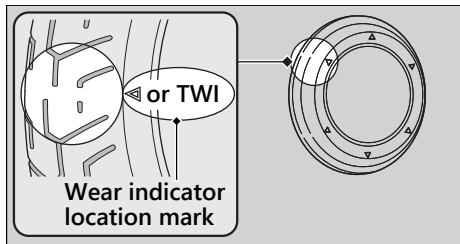

⚠️ WARNING

Riding on tires that are excessively worn or improperly inflated can cause a crash in which you can be seriously hurt or killed.

Follow all instructions in this owner's manual regarding tire inflation and maintenance.

Maintenance Fundamentals

Have your tires replaced by your dealer. For recommended tires, air pressure and minimum tread depth, see "Specifications."

➤ P. 148

Follow these guidelines whenever you replace tires.

- Use the recommended tires or equivalents of the same size, construction, speed rating, and load range.
- Have the wheel balanced with Honda Genuine balance weights or equivalent after the tire is installed.
- Do not install a tube inside a tubeless tire on this motorcycle. Excessive heat build-up can cause the tube to burst.
- Use only tubeless tires on this motorcycle. The rims are designed for tubeless tires, and during hard acceleration or braking, a tube-type tire could slip on the rim and cause the tire to rapidly deflate.

WARNING

Installing improper tires on your motorcycle can adversely affect handling and stability, and can cause a crash in which you can be seriously hurt or killed.

Always use the size and type of tires recommended in this owner's manual.

Tire Service Life

The service life of your tires is dependent on many factors, including, but not limited to, riding habits, road conditions, vehicle loading, tire air pressure, maintenance history, speed, and environmental conditions (even when the tires are not in use).

In addition to your regular inspections and maintenance, it is recommended that you have annual inspections performed once the tires reach 5 years old. It is also recommended that all tires be removed from service after 10 years from the date of manufacture, regardless of their condition or state of wear.

The last four digits of the TIN (tire identification number) indicate the date of manufacture.

Tire Identification Number (TIN)

The tire identification number (TIN) is a group of numbers and letters located on the sidewall of the tire.

① ② ③

DOT XXXX XXXX 22 09

DOT: This indicates that the tire meets all requirements of the U.S. Department of Transportation.

- ① XXXX: Factory code
- ② XXXX: Tire type code
- ③ 22 09: Date of manufacture (week & year).
Example: week 22 in year 09.

Tire Labeling Example

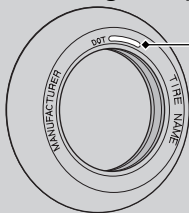

Tire identification number (TIN)

Air Cleaner

This motorcycle is equipped with a viscous type air cleaner element which cannot be cleaned with compressed air or otherwise without degrading its performance.

If the filter becomes dirty, replace it with a new one.

Battery

Removal

Make sure the ignition switch is in the OFF position.

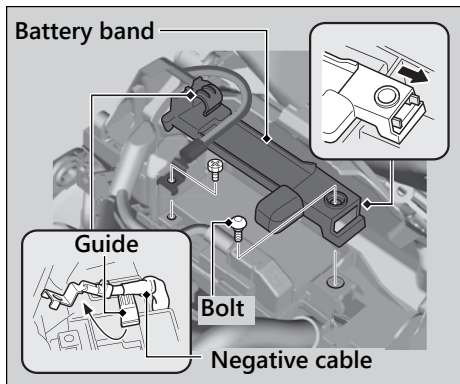

1. Raise the front of the fuel tank. ▣ P. 79
2. Disconnect the negative \ominus terminal from the battery.
3. Remove the negative \ominus cable from the guide.
4. Remove the bolt.
5. Slide the battery band and remove it.

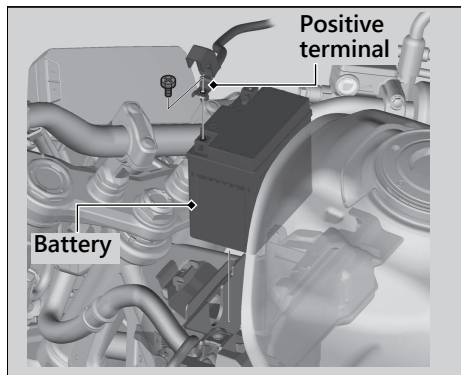

6. Disconnect the positive ⊕ terminal from the battery.
7. Remove the battery taking care not to drop the terminal nuts.
 - Cover the handlebar holders with a protective cloth to prevent the battery terminals from scratching them.

Installation

Install the parts in the reverse order of removal. Always connect the positive ⊕ terminal first. Make sure that bolts and nuts are tight.

Make sure the clock information is correct after the battery is reconnected. ► P. 29
 For proper handling of the battery, see "Maintenance Fundamentals." ► P. 61
 "Battery Goes Dead." ► P. 118

Clip

Removal

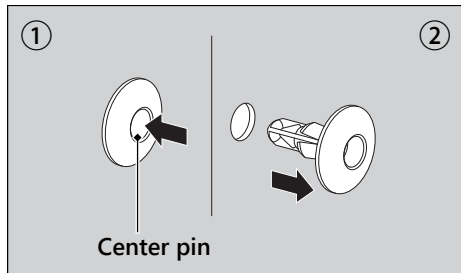

1. Press down on the center pin to release the lock.
2. Pull the clip out of the hole.

Installation

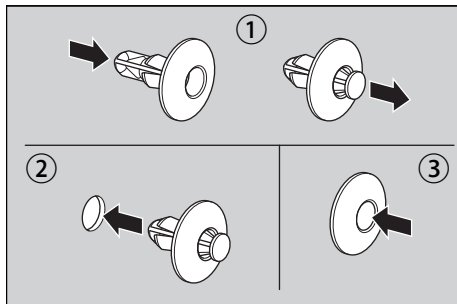

1. Push the bottom of the center pin.
2. Insert the clip into the hole.
3. Press down on the center pin to lock the clip.

Front Seat

Removal

1. Remove the rear seat. ► P. 81
2. Remove the mounting bolts and collars, and then pull the front seat back and up.

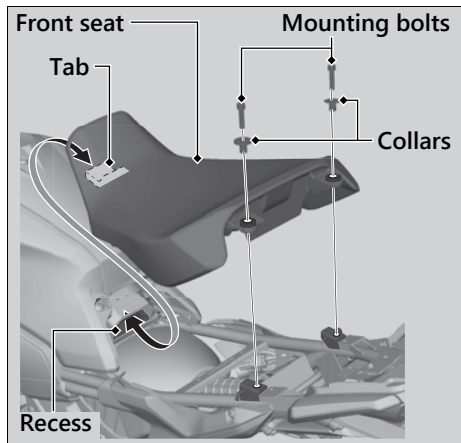

Installation

1. Insert the tab into the recess.
2. Install the collars and mounting bolts.
3. Tighten the mounting bolts securely.

Torque: 7 lbf·ft (10 N·m, 1.0 kgf·m)

- Make sure that the seat is locked securely in position by pulling it up lightly.
4. Install the rear seat. ► P. 81

Fuel Tank Cover Assembly

Removal

1. Remove the front seat. ► P. 76
2. Remove the bolts A.

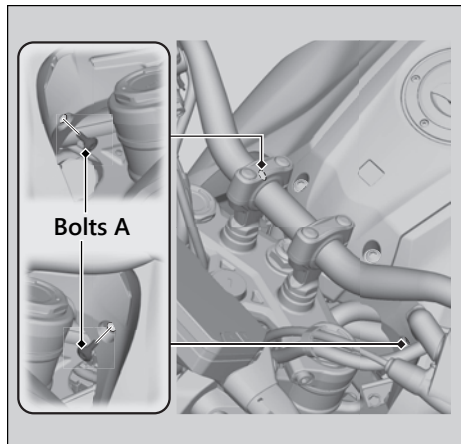

3. Remove the bolts B, bolts C, collars, bolt D and washer.

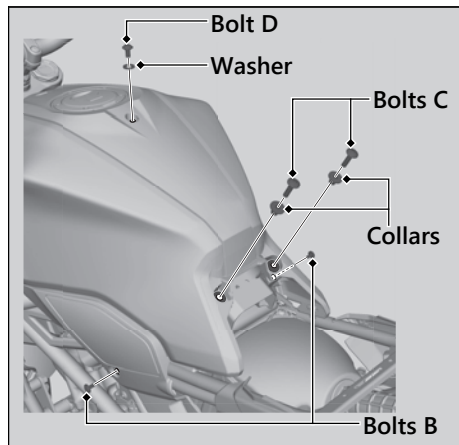

4. Remove the prongs from the grommets and release the slots from the tabs.
5. Carefully widen the both ends of the fuel tank cover assembly and remove it.
 - Be careful not to apply weight to the fuel tank cover assembly.

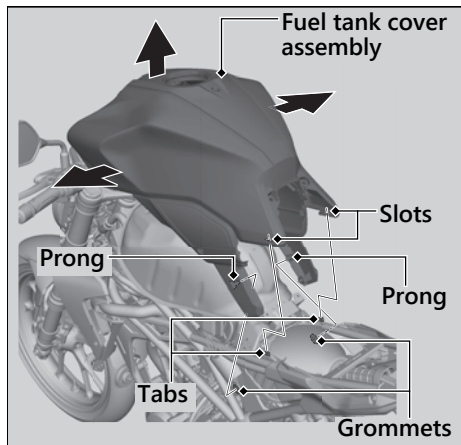

Installation

1. Install the fuel tank cover assembly in the reverse order of removal.
2. Tighten the bolts C and bolt D securely.

Torque: 7 lbf·ft (10 N·m, 1.0 kgf·m)

3. Tighten the bolts A and bolts B securely.

Torque: 3.1 lbf·ft (4.2 N·m, 0.4 kgf·m)

4. Install the front and rear seat. ► P. 76

Fuel Tank Maintenance Position

The front of the fuel tank can be tilted up for maintenance.

The fuel tank does not require draining.

■ Raising The Fuel Tank

1. Place the motorcycle on its side stand on a firm, level surface with the transmission in neutral and turn the ignition switch to the OFF position.

Check that the fuel fill cap is closed.

2. Settle the handlebar straight ahead.
3. Remove the fuel tank cover assembly.
➤ P. 77

4. Remove the mounting bolts and collars on both sides.

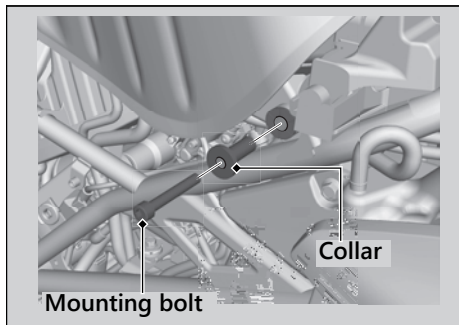

5. Raise the front of the fuel tank.

6. Pull the tab of the battery cover and open it.
► After the battery cover is opened, push down the hinge part to lock it.

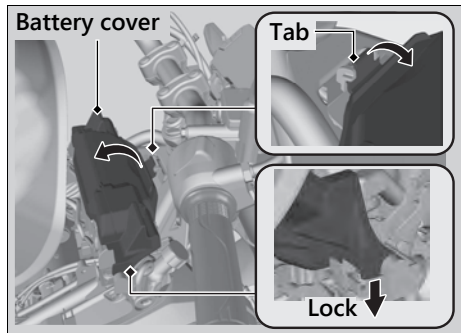

7. Mount the fuel tank on the base of the battery cover.

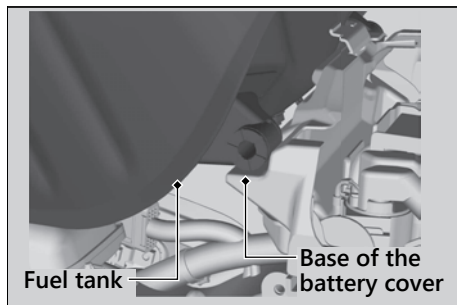

Installation

1. Install the fuel tank in the reverse order of removal.
2. Install the collars and mounting bolts.
3. Tighten the mounting bolts.

Torque: 9 lbf-ft (12 N·m, 1.2 kgf·m)

Rear Seat

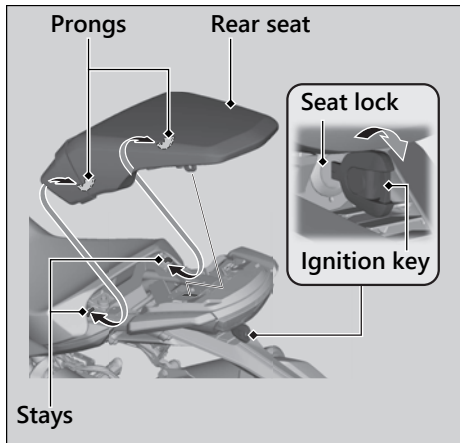

Removal

1. Insert the ignition key into the seat lock.
2. Turn it clockwise, then pull the rear seat up and back.

Installation

1. Insert the prongs into the stays on the frame.
2. Push and down on the rear of the rear seat until it locks in place.
 - Make sure that the seat is locked securely in position by pulling it up lightly.

The seat locks automatically when closed. Take care not to lock your key in the compartment under the rear seat.

Shroud

The right and left shrouds can be removed in the same manner.

Removal

1. Remove the clip (► P. 75) and outer shroud bolt.
2. Remove the outer shroud by releasing the tab from the slot on the inner shroud.

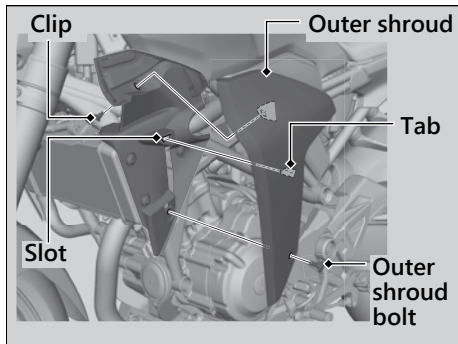

3. Remove the inner shroud bolt A, bolts B and inner shroud.

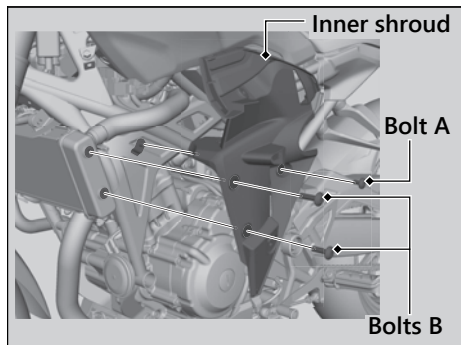

Installation

1. Install the inner shroud and tighten the inner shroud bolts B.

Torque: 7 lbf·ft (10 N·m, 1.0 kgf·m)

2. Install and tighten the inner shroud bolt A.

Torque: 3.1 lbf·ft (4.2 N·m, 0.4 kgf·m)

3. Install the outer shroud by inserting its tab into the slot on the inner shroud.

4. Install and tighten the outer shroud bolt.

Torque: 3.1 lbf·ft (4.2 N·m, 0.4 kgf·m)

5. Install the clip.

Checking the Engine Oil

1. If the engine is cold, idle the engine for 3 to 5 minutes.
2. Turn the ignition switch to the OFF position and wait for 2 to 3 minutes.
3. Place your motorcycle in an upright position on a firm, level surface.
4. Check that the oil level is between the upper level and lower level marks on the oil level inspection window.

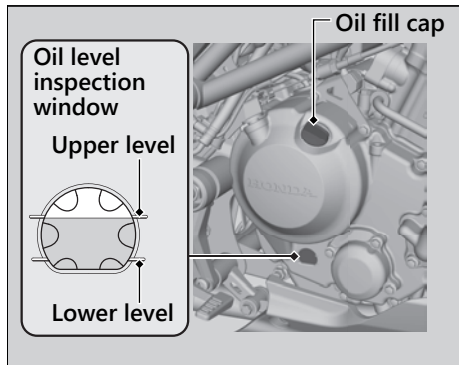

Adding Engine Oil

If the engine oil is below or near the lower level mark, add the recommended engine oil.

► P. 64, ► P. 148

1. Remove the oil fill cap. Add the recommended oil until it reaches the upper level mark.
 - Place your motorcycle in an upright position on a firm, level surface when checking the oil level.
 - Do not overfill above the upper level mark.
 - Make sure no foreign objects enter the oil filler opening.
 - Wipe up any spills immediately.
2. Securely reinstall the oil fill cap.

NOTICE

Overfilling with oil or operating with insufficient oil can cause damage to your engine. Do not mix different brands and grades of oil. They may affect lubrication and clutch operation.

For the recommended oil and oil selection guidelines, see "Maintenance Fundamentals."

► P. 64

Changing Engine Oil & Filter

Changing the oil and filter requires special tools. We recommend that you have your motorcycle serviced by your dealer.

Use a new Honda Genuine oil filter or equivalent specified for your model.

NOTICE

Using the wrong oil filter can result in serious damage to the engine.

1. If the engine is cold, idle the engine for 3 to 5 minutes.
2. Turn the ignition switch to the OFF position and wait for 2 to 3 minutes.
3. Place your motorcycle on a firm, level surface.
4. Place a drain pan under the drain bolt.

5. Remove the oil fill cap, drain bolt, and sealing washer to drain the oil.

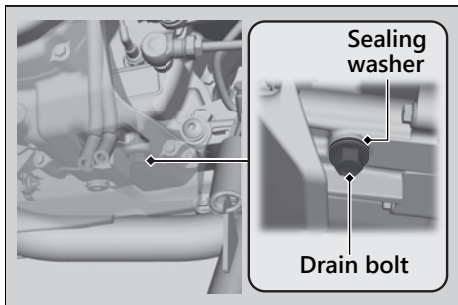

6. Remove the oil filter cover, oil filter, spring and gasket by removing the oil filter cover bolts and let the remaining oil drain out.
 - Discard the oil and oil filter at an approved recycling center.

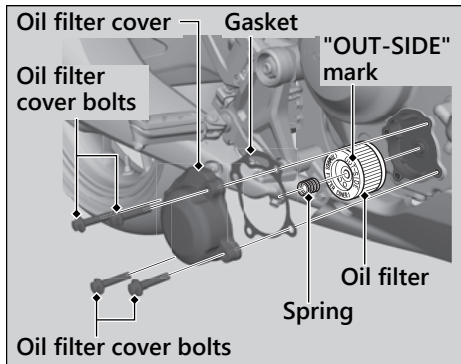

7. Install a new oil filter with its "OUT-SIDE" mark facing out.
8. Install the oil filter spring into the oil filter cover, and then install the oil filter cover with a new gasket.
9. Install and tighten the oil filter cover bolts.

Torque: 9 lbf-ft (12 N·m, 1.2 kgf·m)

10. Install a new sealing washer onto the drain bolt. Tighten the drain bolt.

Torque: 18 lbf-ft (24 N·m, 2.4 kgf·m)

11. Fill the crankcase with the recommended oil (► P. 64, ► P. 148) and install the oil fill cap.

Required oil

When changing oil & engine oil filter:

1.6 US qt (1.5 L)

When changing oil only:

1.5 US qt (1.4 L)

12. Check the oil level. ► P. 84

13. Check that there are no oil leaks.

NOTICE

Improper installation of the oil filter can result in serious damage to the engine.

Checking the Coolant

Check the coolant level in the reserve tank while the engine is cold.

1. Place your motorcycle on a firm, level surface.
2. Hold your motorcycle in an upright position and turn the handlebar to the left.
3. Remove the reserve tank cap/dipstick and wipe it clean.
4. Insert the reserve tank cap/dipstick until it seats, but don't screw it in.
5. Check that the coolant level is between the upper level and lower level marks on the gauge.
6. Securely install the reserve tank cap/dipstick.

If the coolant level is dropping noticeably or the reserve tank is empty, you likely have a serious leak. Have your motorcycle inspected by your dealer.

Reserve tank cap/dipstick

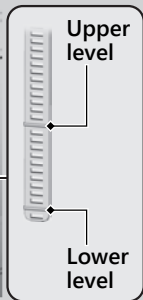
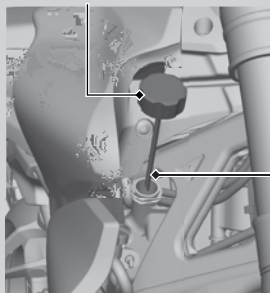

Adding Coolant

If the coolant level is below the lower level mark, add the recommended coolant (P. 67) until the level reaches the upper level mark.

Add fluid only from the reserve tank cap/dipstick and do not remove the radiator cap.

1. Remove the reserve tank cap/dipstick and add fluid while monitoring the coolant level.
 - Do not overfill above the upper level mark.
 - Make sure no foreign objects enter the reserve tank opening.
2. Securely reinstall the reserve tank cap/dipstick.

⚠ WARNING

Removing the radiator cap while the engine is hot can cause the coolant to spray out, potentially scalding you.

Always let the engine and radiator cool down before removing the radiator cap.

Reserve tank cap/dipstick

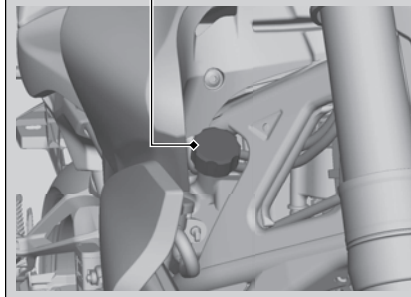

Changing Coolant

Have your dealer change the coolant unless you have the proper tools and are mechanically qualified.

Checking Brake Fluid

1. Place your motorcycle in an upright position on a firm, level surface.
2. **Front** Check that the brake fluid reservoir is horizontal and that the fluid level is above the LWR mark.
Rear Check that the brake fluid reservoir is horizontal and that the fluid level is between the LOWER level and UPPER level marks.

If the brake fluid level in either reservoir is below the LWR mark or LOWER level mark or the brake lever and pedal freeplay becomes excessive, inspect the brake pads for wear. If the brake pads are not worn, you most likely have a leak. Have your motorcycle inspected by your dealer.

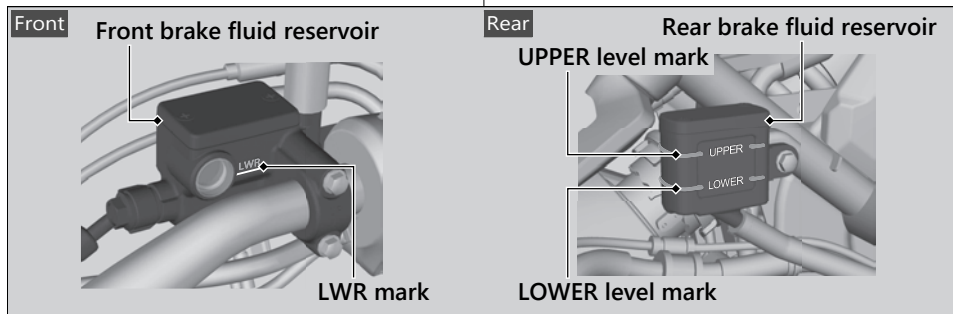

Inspecting the Brake Pads

Check the condition of the brake pad wear indicators.

Front The pads need to be replaced if a brake pad is worn to the bottom of the indicator.

Rear The pads need to be replaced if a brake pad is worn to the indicator.

1. **Front** Inspect the brake pads from in front of the brake caliper.
2. **Rear** Inspect the brake pads from the rear right of the motorcycle.

If necessary have the pads replaced by your dealer.

Always replace both left and right brake pads at the same time.

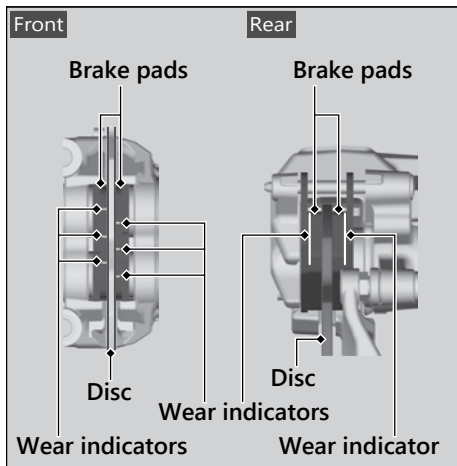

Adjusting the Brake Light Switch

Check the operation of the brake light switch. Hold the brake light switch and turn the adjusting nut in the direction A if the switch operates too late, or turn the nut in the direction B if the switch operates too soon.

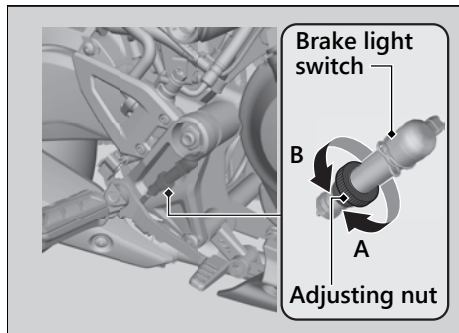

Checking the Side Stand

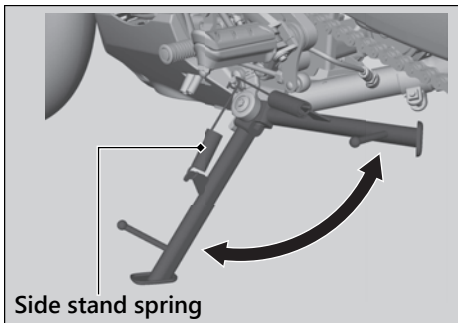

1. Check that the side stand operates smoothly. If the side stand is stiff or squeaky, clean the pivot area and lubricate the pivot bolt with clean grease.
2. Check the spring for damage or loss of tension.
3. Sit on the motorcycle, shift the transmission to Neutral, and raise the side stand.
4. Start the engine, pull the clutch lever in, and shift the transmission into gear.
5. Lower the side stand all the way. The engine should stop as you lower the side stand. If the engine doesn't stop, have your motorcycle inspected by your dealer.

Inspecting the Drive Chain Slack

Check the drive chain slack at several points along the chain. If the slack is not constant at all points, some links may be kinked and binding.

Have the chain inspected by your dealer.

1. Shift the transmission to Neutral. Stop the engine.
2. Place your motorcycle on its side stand on a firm, level surface.
3. Check the slack in the lower half of the drive chain midway between the sprockets.

Drive chain slack:

1 3/16 - 1 9/16 in (30 - 40 mm)

- ▶ Do not ride your motorcycle if the slack exceeds 1 15/16 in (50 mm).

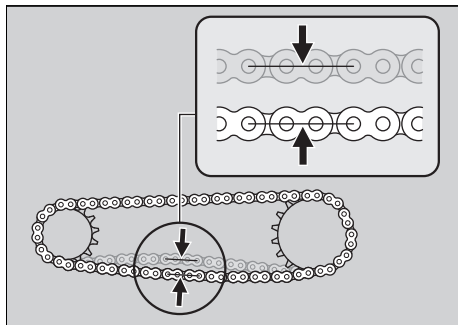

4. Roll the motorcycle forward and check that the chain moves smoothly.
5. Inspect the sprockets. ➤ P. 65
6. Clean and lubricate the drive chain. ➤ P. 66

Adjusting the Drive Chain Slack

Adjusting the chain requires special tools. Have the drive chain slack adjusted by your dealer.

CB300RA only

When adjusting the drive chain slack, be careful not to damage the wheel speed sensor and pulser ring.

1. Shift the transmission to Neutral. Stop the engine.
2. Place your motorcycle on its side stand on a firm, level surface.
3. Loosen the rear axle nut.
4. Loosen the lock nuts on both sides of the swingarm.

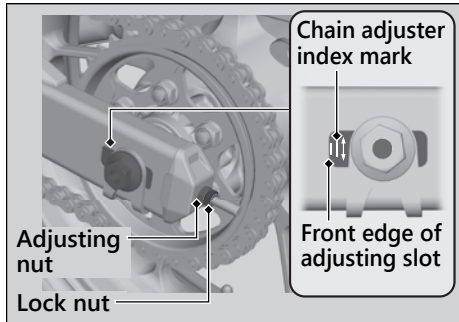
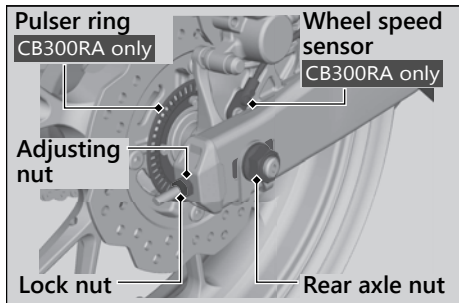

Drive Chain ► Adjusting the Drive Chain Slack

5. Turn both adjusting nuts an equal number of turns until the correct drive chain slack is obtained. Turn the adjusting nuts clockwise to tighten the chain. Turn the adjusting nuts counterclockwise and push the rear wheel toward the front to provide more slack.

Adjust the slack at a point midway between the drive sprocket and the driven sprocket.

Check the drive chain slack. ► P. 94

6. Check rear axle alignment by making sure the chain adjuster index marks align with the front edge of the adjusting slots. Both marks should correspond. If the axle is misaligned, turn the right or left adjusting nuts until the marks are aligned and recheck drive chain slack.

7. Tighten the rear axle nut.

Torque: 65 lbf-ft (88 N·m, 9.0 kgf-m)

8. Tighten the drive chain adjusting nuts lightly, then hold the adjusting nuts and tighten the lock nuts.
9. Recheck drive chain slack.

If a torque wrench was not used for installation, see your dealer as soon as possible to verify proper assembly. Improper assembly may lead to loss of braking capacity.

Checking the Drive Chain Wear

Check the chain wear label when adjusting the drive chain. If the arrow mark on the drive chain adjuster enters the red zone on the label after the chain has been adjusted to the proper slack, the chain is excessively worn and must be replaced.

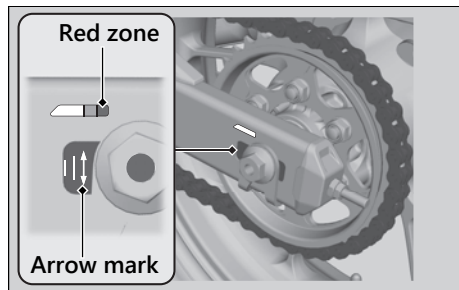

Chain:

DID 520VF or RK 520KLO2

If necessary have the drive chain replaced by your dealer.

Checking the Drive Chain Slider

Check the condition of the drive chain slider. The drive chain slider will need to be replaced if the chain slider is worn to the bottom of any wear indicator. If necessary have the drive chain slider replaced by your dealer.

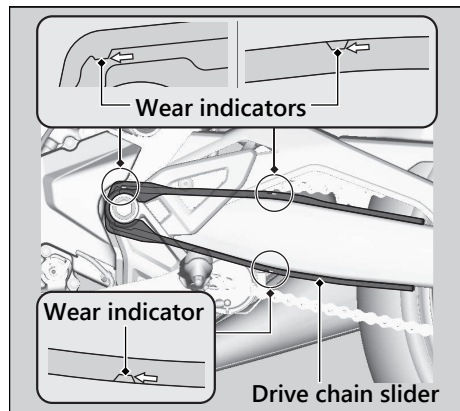

Checking the Clutch

Checking the Clutch Lever Freeplay

Check the clutch lever freeplay.

Freeplay at the clutch lever:

$3/8$ - $13/16$ in (10 - 20 mm)

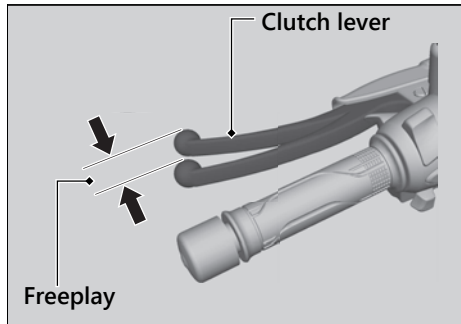

Check the clutch cable for kinks or signs of wear. If necessary have it replaced by your dealer.

Lubricate the clutch cable with a commercially available cable lubricant to prevent premature wear and corrosion.

NOTICE

Improper freeplay adjustment can cause premature clutch wear.

Adjusting the Clutch Lever Freeplay

I Upper Adjustment

Attempt adjustment with the upper clutch cable adjuster first.

1. Pull back the rubber dust cover.
2. Loosen the upper lock nut.
3. Turn the upper clutch cable adjuster until the freeplay is $3/8 - 13/16$ in (10 - 20 mm).
4. Tighten the upper lock nut and check the freeplay again.
5. Install the rubber dust cover.

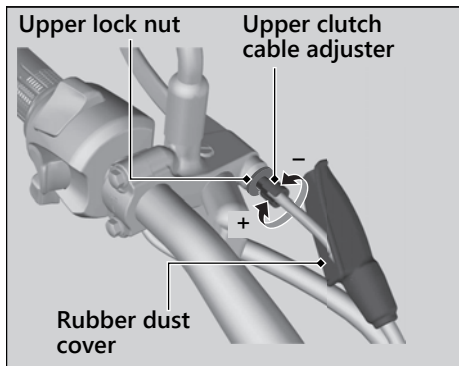

Lower Adjustment

If the upper clutch cable adjuster is threaded out near its limit, or the correct freeplay cannot be obtained, attempt adjustment with the lower clutch cable adjusting nut.

1. Loosen the upper lock nut and turn the upper clutch cable adjuster all the way in (to provide maximum freeplay). Tighten the upper lock nut.
2. Loosen the lower lock nut.
3. Turn the lower adjusting nut until the clutch lever freeplay is $3/8 - 13/16$ in (10 - 20 mm).
4. Tighten the lower lock nut and check the clutch lever freeplay.
5. Start the engine, pull the clutch lever in, and shift into gear. Make sure the engine does not stall and the motorcycle does not creep. Gradually release the clutch lever and open the throttle. Your motorcycle should move smoothly and accelerate gradually.

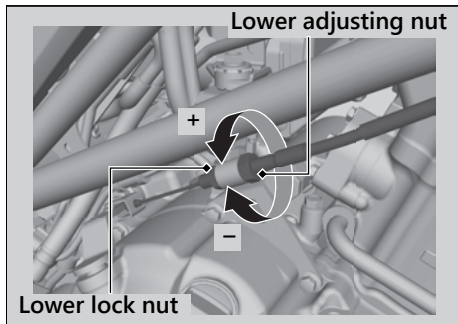

If proper adjustment cannot be obtained or the clutch does not work correctly, see your dealer.

Checking the Throttle

With the engine off, check that the throttle rotates smoothly from fully closed to fully open in all steering positions and throttle freeplay is correct. If the throttle does not move smoothly, close automatically, or if the cable is damaged, have the motorcycle inspected by your dealer.

Freeplay at the throttle grip flange:

1/16 - 1/4 in (2 - 6 mm)

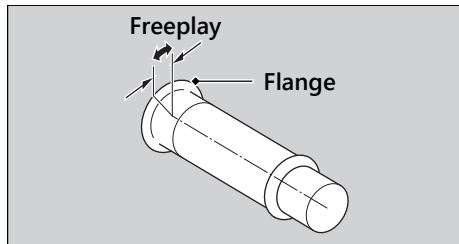

Adjusting the Throttle Freeplay

1. Slide the cable boot.
2. Loosen the lock nut.
3. Turn the adjuster until the freeplay is 1/16 - 1/4 in (2 - 6 mm).
4. Tighten the lock nut, return the cable boot, and inspect the throttle action again.

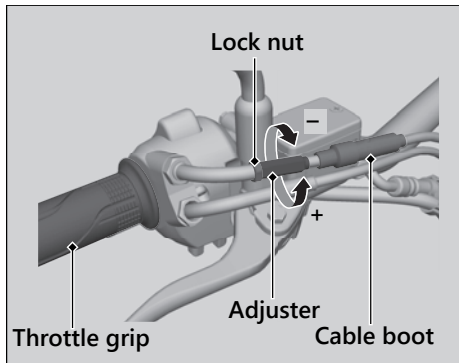

Cleaning the Crankcase Breather

1. Place a suitable container under the crankcase breather tube.
2. Remove the crankcase breather tube plug from the tube.
3. Drain deposits into a suitable container.
4. Install the crankcase breather tube plug.

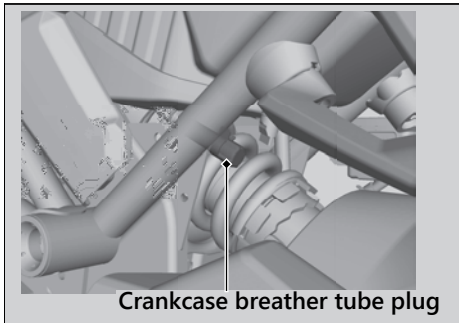

Adjusting the Headlight Aim

You can adjust vertical aim of the headlight for proper alignment. Turn the pinion in or out as necessary using a Phillips screwdriver. Obey local laws and regulations.

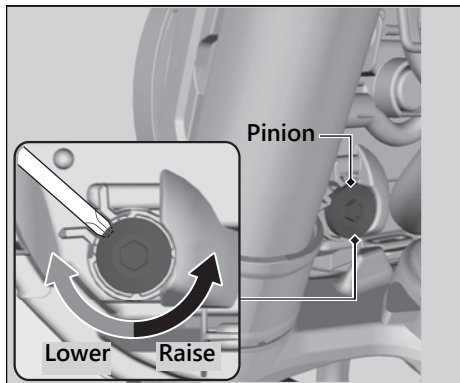

Adjusting the Rear Suspension

Adjusting the suspension requires a pin spanner. We recommend that you have your motorcycle serviced by your dealer.

Spring Preload

You can adjust the spring preload by the adjuster to suit the load or the road surface. Use the pin spanner to turn the adjuster. Position 1 is for a decrease spring preload (soft), or turn the position 3 to 7 increase spring preload (hard). The standard position is 2.

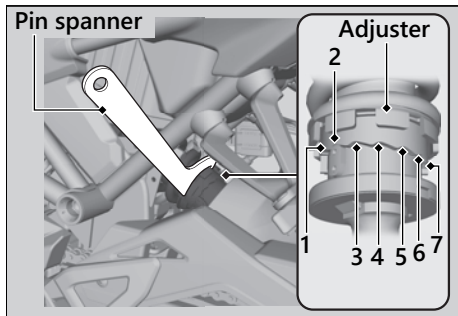

NOTICE

Attempting to adjust directly from 1 to 7 or 7 to 1 may damage the shock absorber.

NOTICE

Do not turn the adjuster beyond its limits.

NOTICE

The rear shock absorber damper unit contains high pressure nitrogen gas. Do not attempt to disassemble, service, or improperly dispose of the damper. See your dealer.

Troubleshooting

Engine Will Not Start	P. 106
Overheating (Segment H flashes in coolant temperature gauge)	P. 107
Warning Indicators On or Flashing	P. 108
PGM-FI (Programmed Fuel Injection)	
Malfunction Indicator Lamp (MIL).....	P. 108
ABS (Anti-lock Brake System) Indicator	P. 109
Other Warning Indications	P. 110
Fuel Gauge Failure Indication.....	P. 110
Tire Puncture	P. 111
Electrical Trouble	P. 118
Battery Goes Dead.....	P. 118
Burned-out Light Bulb	P. 118
Blown Fuse	P. 121

Unstable Engine Operation Occurs Intermittently	P. 123
--	--------

Starter Motor Operates But Engine Does Not Start

Check the following items:

- Check the correct engine starting sequence. ➤ P. 45
- Check that there is gasoline in the fuel tank.
- Check if the PGM-FI malfunction indicator lamp (MIL) is on.
 - ▶ If the indicator lamp is on, contact your dealer as soon as possible.

Starter Motor Does Not Operate

Check the following items:

- Check the correct engine starting sequence. ➤ P. 45
- Make sure engine stop switch is in the  (Run) position. ➤ P. 42
- Check for a blown fuse. ➤ P. 121
- Check for a loose battery connection (➤ P. 73) or battery terminal corrosion (➤ P. 61).
- Check the condition of the battery.
 - P. 118

If the problem continues, have your motorcycle inspected by your dealer.

Overheating (Segment H flashes in coolant temperature gauge)

The engine is overheating when the following occurs:

- The segment H flashes in the coolant temperature gauge.
- Acceleration becomes sluggish.
If this occurs, pull safely to the side of the road and perform the following procedure.

Extended fast idling may cause the segment H to flash.

NOTICE

Continuing to ride with an overheated engine can cause serious damage to the engine.

1. Stop the engine using the ignition switch, and then turn the ignition switch to the ON position.

2. Check that the radiator fan is operating, and then turn the ignition switch to the OFF position.

If the fan is not operating:

Suspect a fault. Do not start the engine. Transport your motorcycle to your dealer.

If the fan is operating:

Allow the engine to cool with the ignition switch in the OFF position.

3. After the engine has cooled, inspect the radiator hose and check if there is a leak.
➔ P. 88

If there is a leak:

Do not start the engine. Transport your motorcycle to your dealer.

4. Check the coolant level in the reserve tank. ➔ P. 88
▶ Add coolant as necessary.
5. If 1-4 check normal, you may continue riding, but closely monitor the temperature gauge.

PGM-FI (Programmed Fuel Injection) Malfunction Indicator Lamp (MIL)

If the indicator comes on while riding, you may have a serious problem with the PGM-FI system. Reduce speed and have your motorcycle inspected by your dealer as soon as possible.

ABS (Anti-lock Brake System) Indicator

CB300RA only

If the indicator operates in one of the following ways, you may have a serious problem with the ABS. Reduce your speed and have your motorcycle inspected by your dealer as soon as possible.

- Indicator comes on or starts flashing while riding.
- Indicator does not come on when the ignition switch is in the ON position.
- Indicator does not go off at speeds above 6 mph (10 km/h).

If the ABS indicator stays on, your brakes will continue to work as a conventional system, but without the anti-locking function.

The ABS indicator may flash if you turn the rear wheel while the rear wheel is lifted off the ground. In this case, turn the ignition switch to the OFF position, and then to the ON position again. The ABS indicator will go off after your speed reaches 19 mph (30 km/h).

Fuel Gauge Failure Indication

If the fuel system has an error, the fuel gauge indicators will be displayed as shown in the illustration.

If this occurs, see your dealer as soon as possible.

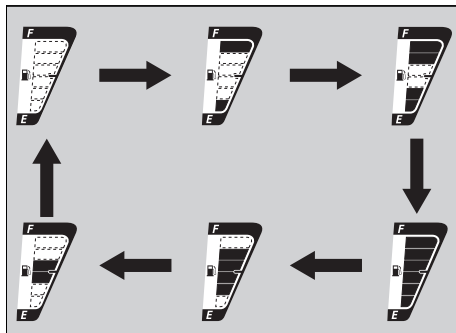
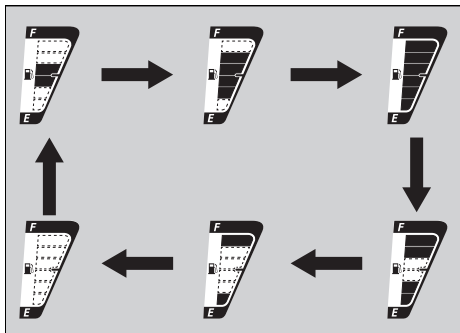

Tire Puncture

Repairing a puncture or removing a wheel requires special tools and technical expertise. We recommend you have this type of service performed by your dealer.

After an emergency repair, always have the tire inspected/replaced by your dealer.

Emergency Repair Using a Tire Repair Kit

If your tire has a minor puncture, you can make an emergency repair using a tubeless tire repair kit.

Follow the instructions provided with the emergency tire repair kit.

Riding your motorcycle with a temporary tire repair is very risky. Do not exceed 30 mph (50 km/h). Have the tire replaced by your dealer as soon as possible.

WARNING

Riding your motorcycle with a temporary tire repair can be risky. If the temporary repair fails, you can crash and be seriously injured or killed.

If you must ride with a temporary tire repair, ride slowly and carefully and do not exceed 30 mph (50 km/h) until the tire is replaced.

Removing Wheels

Follow these procedures if you need to remove a wheel in order to repair a puncture.

CB300RA only

When removing and installing the wheel, be careful not to damage the wheel speed sensor and pulser ring.

Front Wheel

Removal

1. Place your motorcycle on a firm, level surface.
2. Cover right side of the front wheel and brake caliper with protective tape or cloth.
3. Loosen the front axle nut.
4. Loosen the axle pinch bolt on both sides.
5. Support your motorcycle securely and raise the front wheel off the ground using a maintenance stand or a hoist.

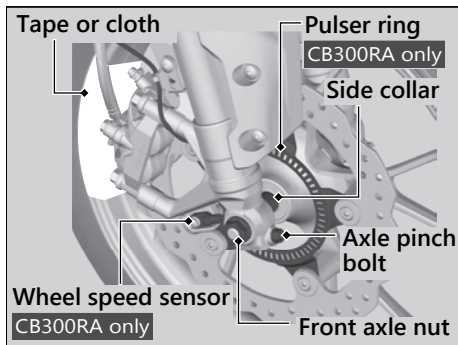

6. Remove the front axle nut, front axle shaft, front wheel and side collars.
- Avoid getting grease, oil, or dirt on the disc or pad surfaces.
 - Do not pull the brake lever while the front wheel is removed.

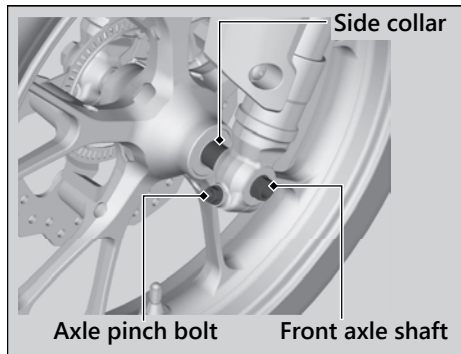

Installation

1. Attach the side collars to the front wheel.
2. Position the front wheel between the fork legs and insert the front axle shaft from the left side, through the left fork leg and wheel hub.

NOTICE

When installing a wheel or caliper into original position, carefully fit the brake disc between the pads to avoid scratching them.

3. Install and tighten the front axle nut.

Torque: 44 lbf-ft (59 N·m, 6.0 kgf-m)

4. Tighten the axle pinch bolt on both sides.

Torque: 18 lbf-ft (24 N·m, 2.4 kgf-m)

Tire Puncture ► Removing Wheels

5. After installing the wheel, apply the brake lever several times, then check if the wheel rotates freely. Recheck the wheel if the brake drags or if the wheel does not rotate freely.
6. Remove the protective tape or cloth.

If a torque wrench was not used for installation, see your dealer as soon as possible to verify proper assembly. Improper assembly may lead to loss of braking capacity.

Rear Wheel

Removal

1. Support your motorcycle securely and raise the rear wheel off the ground using a maintenance stand or a hoist.
2. Loosen the rear axle nut, lock nuts and turn the adjusting nuts so the rear wheel can be moved all the way forward for maximum drive chain slack.
3. Remove the rear axle nut and axle washer.

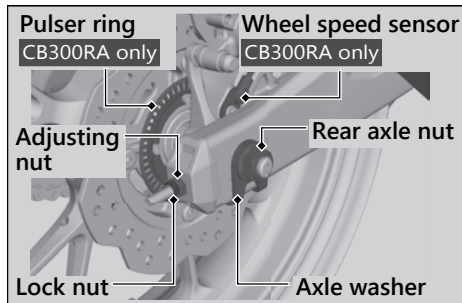

4. Remove the drive chain from the driven sprocket by pushing the rear wheel forward.

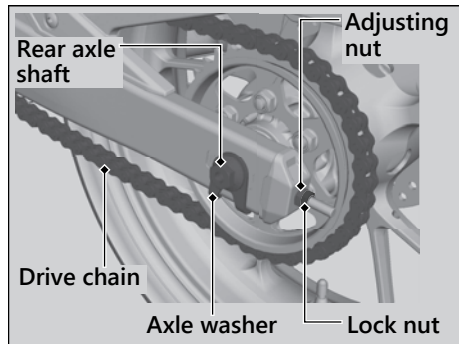

5. Remove the rear axle shaft, side collars, axle washer and rear wheel.
 - Support the brake caliper assembly so that it doesn't hang from the brake hose. Do not twist the brake hose.
 - Avoid getting grease, oil, or dirt on the disc or pad surfaces.
 - Do not push the brake pedal while the brake caliper is removed.

Installation

1. Attach the right and left side collars in their original locations on the wheel.
2. To install the rear wheel, reverse the removal procedure.
 - Take care to prevent the brake caliper from scratching the wheel during installation.

NOTICE

When installing a wheel or caliper into original position, carefully fit the brake disc between the pads to avoid scratching them.

3. Make sure that the lug on the brake caliper bracket is positioned in the slot on the swingarm.

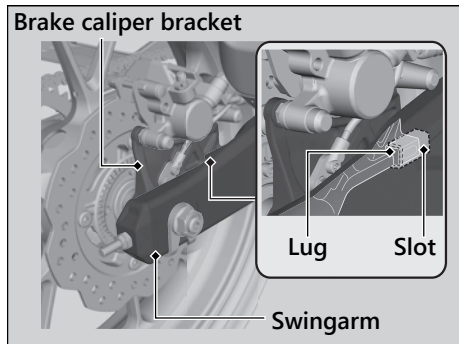

4. Adjust the drive chain slack. ► P. 95
5. Install and tighten the rear axle nut.

Torque: 65 lbf·ft (88 N·m, 9.0 kgf·m)

6. Tighten the drive chain adjusting nuts lightly, then hold the adjusting nuts and tighten the lock nuts.
7. After installing the wheel, apply the brake pedal several times, then check if the wheel rotates freely. Recheck the wheel if the brake drags or if the wheel does not rotate freely.

If a torque wrench was not used for installation, see your dealer as soon as possible to verify proper assembly. Improper assembly may lead to loss of braking capacity.

Battery Goes Dead

Charge the battery using a motorcycle battery charger.

Remove the battery from the motorcycle before charging.

Do not use an automobile-type battery charger, as these can overheat a motorcycle battery and cause permanent damage. If the battery does not recover after recharging, contact your dealer.

NOTICE

Jump starting using an automobile battery can damage your motorcycle's electrical system and is not recommended.

Bump starting is also not recommended.

Burned-out Light Bulb

All light bulbs on the motorcycle are LEDs. If there is a LED which is not turned on, see your dealer for servicing.

| Headlight

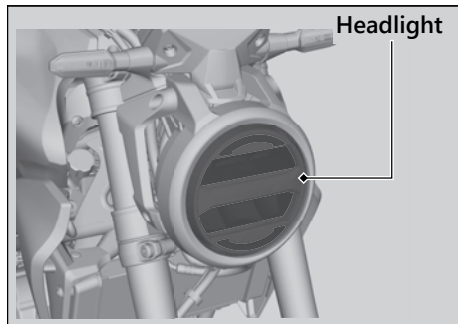

The headlight uses several LEDs. If there is a LED which is not turned on, see your dealer for servicing.

| Brake Light/Taillight

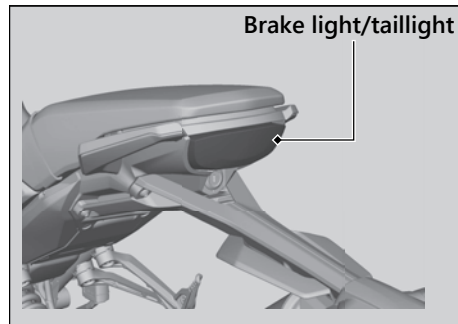

The brake light and taillight use several LEDs. If there is a LED which is not turned on, see your dealer for servicing.

Front and Rear Turn Signal Lights

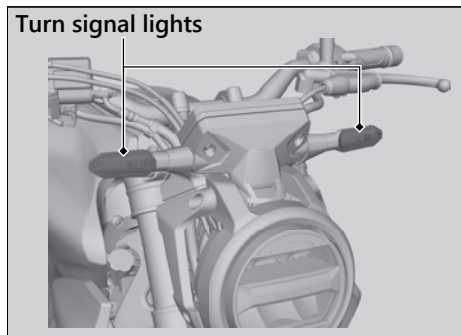

The front and rear turn signal lights use several LEDs.
If there is a LED which is not turned on, see your dealer for servicing.

License Plate Light

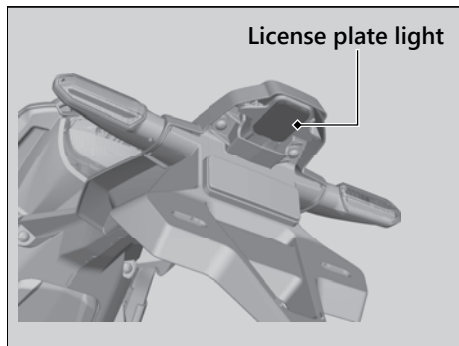

The license plate light uses a LED.
If there is a LED which is not turned on, see your dealer for servicing.

Blown Fuse

Before handling fuses, see “Inspecting and Replacing Fuses.” ▣ P. 63

▣ Fuse Box Fuses

1. Remove the left shroud. ▣ P. 82
2. Pull out the fuse boxes from the battery case.
3. Open the fuse box covers.
4. Pull out the fuses one by one with the fuse puller and check for a blown fuse. Always replace a blown fuse with a spare fuse of the same rating.
5. Close the fuse box covers.
6. Reinstall parts in the reverse order of removal.

CB300RA

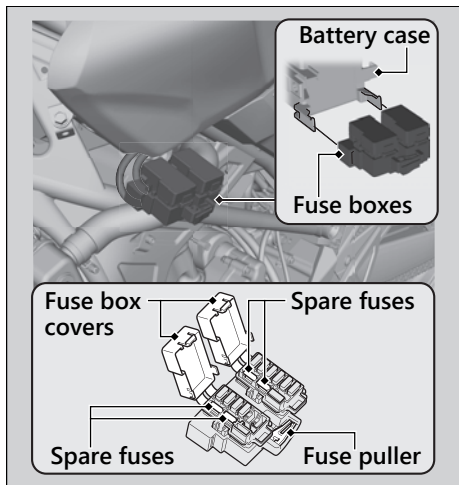

CB300R

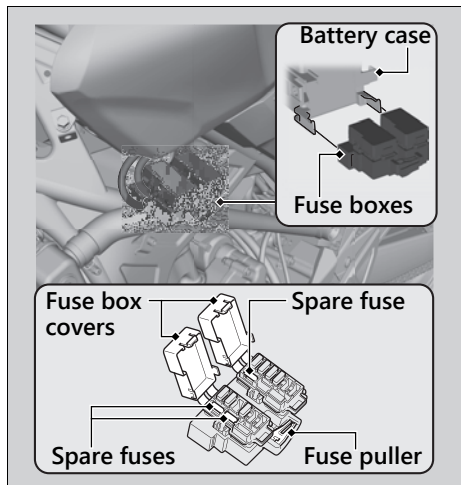

NOTICE

If a fuse fails repeatedly, you likely have an electrical problem. Have your motorcycle inspected by your dealer.

Unstable Engine Operation Occurs Intermittently

If the fuel pump filter is clogged, unstable engine operation will occur intermittently while riding.

Even if this symptom occurs, you can continue to ride your motorcycle.

If unstable engine operation occurs even if sufficient fuel is available, have your motorcycle inspected by your dealer as soon as possible.

Information

Keys.....	P. 125
Instruments, Controls, & Other Features...	P. 126
Caring for Your Motorcycle	P. 127
Storing Your Motorcycle	P. 130
Transporting Your Motorcycle.....	P. 131
You & the Environment	P. 132
Vehicle Identification Number.....	P. 133
Emission Control Systems	P. 134
Catalytic Converter	P. 139
Oxygenated Fuels.....	P. 140
Authorized Manuals	P. 141
Warranty Coverage and Service	P. 142
Honda Contacts.....	P. 144
USA Reporting Safety Defects	P. 146

Keys

Ignition Key

This motorcycle has two ignition keys and a key tag with a key number and a bar code. Store the spare key and the key tag in a safe location. To make a duplicate key, take the spare key and the key tag to your dealer or a locksmith. If you lose all ignition keys and the key tag, the ignition switch assembly will probably have to be removed by your dealer to determine the key number.

A metal key holder may cause damage to the area surrounding the ignition switch.

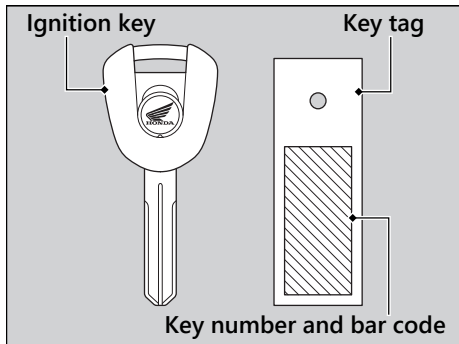

Instruments, Controls, & Other Features

Ignition Switch

Leaving the ignition switch in the ON position with the engine stopped will drain the battery.

Do not turn the key while riding.

Engine Stop Switch

Do not use the engine stop switch except in an emergency. Doing so when riding will cause the engine to suddenly turn off, making riding unsafe. If you stop the engine using the engine stop switch, turn the ignition switch to the OFF position. Failing to do so will drain the battery.

Odometer

The display locks at 999,999 when the read-out exceeds 999,999.

Tripmeter

The tripmeters return to 0.0 when each read-out exceeds 9,999.9.

Document Bag

The owner's manual, registration, and insurance information can be stored in the plastic document bag located underside of the rear seat.

Ignition Cut-off System

A banking (lean angle) sensor automatically stops the engine and fuel pump if the motorcycle falls over. To reset the sensor, you must turn the ignition switch to the OFF position and back to the ON position before the engine can be restarted.

Caring for Your Motorcycle

Frequent cleaning and polishing is important to ensure the life of your Honda. A clean motorcycle makes it easier to spot potential problems.

In particular, seawater and salts used to prevent ice on roads promote the formation of corrosion. Always wash your motorcycle thoroughly after riding on coastal or treated roads.

Washing

Allow the engine, muffler, brakes, and other high-temperature parts to cool before washing.

1. Rinse your motorcycle thoroughly using a low pressure garden hose to remove loose dirt.
2. If necessary, use a sponge or a soft towel with mild cleaner to remove road grime.
 - ▶ Clean the headlight lens, panels, and other plastic components with extra care to avoid scratching them.

Avoid directing water into the air cleaner, muffler, and electrical parts.

3. Thoroughly rinse your motorcycle with plenty of clean water and dry with a soft, clean cloth.
4. After the motorcycle dries, lubricate any moving parts.
 - ▶ Make sure that no lubricant spills onto the brakes or tires. Brake discs, pads, drum or shoes contaminated with oil will suffer greatly reduced braking effectiveness and can lead to a crash.
5. Lubricate the drive chain immediately after washing and drying the motorcycle.
6. Apply a coat of wax to prevent corrosion.
 - ▶ Avoid products that contain harsh detergents or chemical solvents. These can damage the metal, paint, and plastic on your motorcycle. Keep the wax clear of the tires and brakes.
 - ▶ If your motorcycle has any matte painted parts, do not apply a coat of wax to the matte painted surface.

Washing Precautions

Follow these guidelines when washing:

- Do not use high-pressure washers:
 - ▶ High-pressure water cleaners can damage moving parts and electrical parts, rendering them inoperable.
 - ▶ Water in the air intake can be drawn into the throttle body and/or enter the air cleaner.
 - Do not direct water at the muffler:
 - ▶ Water in the muffler can prevent starting and causes rust in the muffler.
 - Dry the brakes:
 - ▶ Water adversely affects braking effectiveness. After washing, apply the brakes intermittently at low speed to help dry them.
 - Do not direct water under the seat:
 - ▶ Water in the under seat compartment can damage your documents and other belongings.
-
- Do not direct water at the air cleaner:
 - ▶ Water in the air cleaner can prevent the engine from starting.
 - Do not direct water near the headlight:
 - ▶ The headlight's inside lens may fog temporarily after washing or while riding in the rain. This does not impact the headlight function. However, if you see a large amount of water or ice accumulated inside the lens(es), have your vehicle inspected by your dealer.
 - Do not use wax or polishing compounds on matte painted surface:
 - ▶ Use a soft cloth or sponge, plenty of water, and a mild detergent to clean matte painted surfaces. Dry with a soft clean cloth.

Aluminum Components

Aluminum will corrode from contact with dirt, mud, or road salt. Clean aluminum parts regularly and follow these guidelines to avoid scratches:

- Do not use stiff brushes, steel wool, or cleaners containing abrasives.
- Avoid riding over or scraping against curbs.

Panels

Follow these guidelines to prevent scratches and blemishes:

- Wash gently using a soft sponge and plenty of water.
- To remove stubborn stains, use diluted detergent and rinse thoroughly with plenty of water.
- Avoid getting gasoline, brake fluid, or detergents on the instruments, panels, or headlight.

Exhaust Pipe and Muffler

When the exhaust pipe and muffler are painted, do not use a commercially available abrasive kitchen cleaning compound. Use a neutral detergent to clean the painted surface on the exhaust pipe and muffler. If you are not sure if your exhaust pipe and muffler are painted, contact your dealer.

Storing Your Motorcycle

If you store your motorcycle outdoors, you should consider using a full-body motorcycle cover.

If you won't be riding for an extended period, follow these guidelines:

- Wash your motorcycle and wax all painted surfaces (except matte painted surfaces). Coat chrome pieces with rust-inhibiting oil.
- Lubricate the drive chain. ➤ P. 65
- Place your motorcycle on a maintenance stand and position a block so that both tires are off the ground.
- After rain, remove the body cover and allow the motorcycle to dry.
- Remove the battery (➤ P. 73) to prevent discharge. Fully charge the battery and then place it in a shaded, well-ventilated area.
 - ▶ If you leave the battery in place, disconnect the negative ⊖ terminal to prevent discharge.

After removing your motorcycle from storage, inspect all maintenance items required by the Maintenance Schedule.

USA For more information about storage, refer to the *Honda Winter Storage Guide*, available from your dealer.

Canada For more information about storage, visit our website at www.honda.ca and look up "Storage Tips" under the "Honda Warranty" in the Warranty tab for your Model.

Transporting Your Motorcycle

If your motorcycle needs to be transported, it should be carried on a motorcycle trailer or a flatbed truck or trailer that has a loading ramp or lifting platform, and motorcycle tie-down straps. Never try to tow your motorcycle with a wheel or wheels on the ground.

NOTICE

Towing your motorcycle can cause serious damage to the transmission.

You & the Environment

Owning and riding a motorcycle can be enjoyable, but you must do your part to protect the environment.

Choose Sensible Cleaners

Use a biodegradable detergent when you wash your motorcycle. Avoid aerosol spray cleaners that contain chlorofluorocarbons (CFCs) which damage the atmosphere's protective ozone layer.

Recycle Wastes

Put oil and other toxic wastes in approved containers and take them to a recycling center. Call your local or state office of public works or environmental services to find a recycling center in your area, and to get instructions on how to dispose of non-recyclable wastes. Do not place used engine oil in the trash, or pour it down a drain or on the ground. Used oil, gasoline, coolant, and cleaning solvents contain poisons that can hurt refuse workers and contaminate drinking water, lakes, rivers, and oceans.

Vehicle Identification Number

The VIN and engine serial number uniquely identify your motorcycle and are required in order to register your motorcycle. They may also be required when ordering replacement parts.

You should record these numbers and keep them in a safe place.

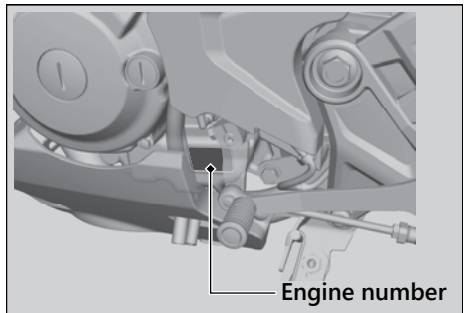
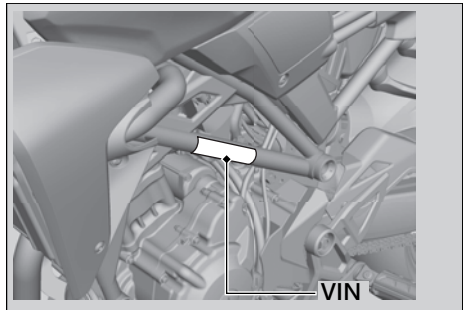
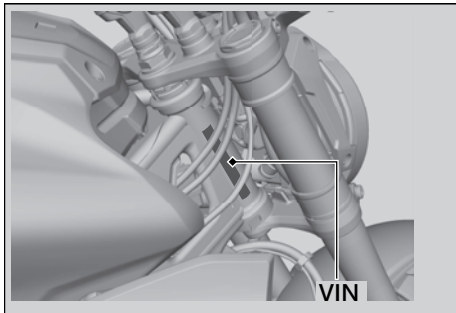

Emission Control Systems

Your motorcycle engine emits combustion byproducts, including carbon monoxide (CO), oxides of nitrogen (NO_x), and hydrocarbons (HC). Gasoline evaporation also emits hydrocarbons. Controlling the production of NO_x, CO, and HC is important for the environment.

Exhaust Emission Requirements

The U.S. Environmental Protection Agency (EPA), the California Air Resources Board (CARB), and Environment and Climate Change Canada (ECCC) require that your motorcycle comply with applicable exhaust, crankcase, and fuel permeation emission standards during its useful life, when operated and maintained according to the instructions provided. CARB also requires that your motorcycle comply with applicable evaporative emission requirements during its useful life, when

operated and maintained according to the instructions provided.

USA Compliance with the terms of the Distributor's Warranties for Honda Motorcycle Emission Control Systems is necessary in order to maintain a valid emissions system warranty.

The Vehicle Emission Control Information label is located on the left side of the swingarm.

Vehicle emission control information label

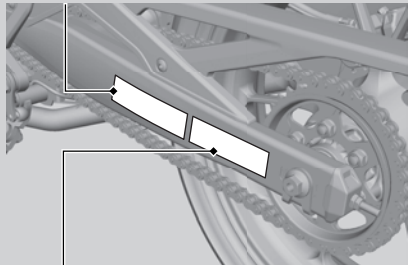

Canada only

Vehicle emission control information label

Noise Emission Requirements

The EPA requires that motorcycles built after January 1, 1983 comply with applicable noise emission standards for one year or 3,730 miles (6,000 km) after the time of purchase when operated and maintained according to the instructions provided.

Exhaust Emission Control System

The exhaust emission control system includes the following components that should not need adjustment, although periodic inspection by your dealer is recommended.

PGM-FI System

The PGM-FI (programmed fuel injection) system uses sequential multiport fuel injection, and is comprised of air intake, engine control, fuel control, and exhaust control subsystems. The engine control module (ECM) uses sensors to

determine how much air enters the engine, and then controls how much fuel to inject.

Ignition Timing Control System

The ignition timing control system adjusts the ignition timing to reduce the amount of HC, CO, and NO_x produced.

Secondary Air Injection System

The secondary air injection system adds filtered air into the exhaust gas to help improve emission control performance.

Catalytic Converters

The exhaust system contains one or more catalytic converters. Catalytic converters use a catalyst to convert most of the harmful exhaust gas compounds into harmless compounds.

Evaporative Emission Control System

50 STATE (meets California)

An evaporative emissions control system uses a canister filled with charcoal to adsorb fuel vapor from the fuel tank while the engine is off. The vapor is drawn into the engine and burned while riding.

Crankcase Emissions Control System

The engine is equipped with a closed crankcase system to prevent discharging crankcase emissions into the atmosphere.

Blow-by gas is returned to the combustion chamber through the front cylinder head, air cleaner housing and throttle body.

Fuel Permeation Emission Control

The fuel tank, fuel hoses, and fuel vapor charge hoses use fuel permeation control technologies to prevent fuel vapor emissions. Tampering with these components to reduce or defeat the effectiveness of the fuel permeation technologies is prohibited.

Noise Emission Control System

TAMPERING WITH THE NOISE CONTROL SYSTEM IS PROHIBITED:

U. S. federal law prohibits, and Canadian provincial laws may prohibit, the following acts or the causing thereof: (1) The removal or rendering inoperative by any person, other than for purposes of maintenance, repair or replacement, of any device or element of design incorporated into any new vehicle for the purpose of noise control prior to its sale or delivery to the ultimate purchaser or while it is in use; or (2) the use of the vehicle after such device or element of design has been removed or rendered inoperative by any person.

AMONG THOSE ACTS PRESUMED TO CONSTITUTE TAMPERING ARE THE FOLLOWING ACTS:

- Removal of, or puncturing the muffler, baffles, header pipes or any other component which conducts exhaust gases.
- Removal of, or puncturing of any part of the intake system.
- Lack of proper maintenance.
- Removing or disabling any emissions compliance component, or replacing any compliance component with a noncompliant component.

Problems Affecting Motorcycle Exhaust Emissions

Have your motorcycle inspected and repaired by your dealer if you experience any of the following symptoms:

- Hard starting or stalling after starting
- Rough idling
- Misfiring or backfiring during acceleration
- Poor engine performance and poor fuel economy

Catalytic Converter

This motorcycle is equipped with a three-way catalytic converter. The catalytic converter contains precious metals that serve as catalysts in high temperature chemical reactions that convert hydrocarbons (HC), carbon monoxide (CO), and oxides of nitrogen (NOx) in the exhaust gasses into safe compounds.

A defective catalytic converter contributes to air pollution and can impair your engine's performance. A replacement unit must be an original Honda part or equivalent.

Follow these guidelines to protect your motorcycle's catalytic converter.

- Always use unleaded gasoline. Leaded gasoline will damage the catalytic converter.
- Keep the engine in good running condition. A poorly running engine can cause the catalytic converter to overheat causing damage to the converter or the motorcycle.
- If your engine is misfiring, backfiring, stalling, or otherwise not running properly, stop riding and turn off the engine. Have your motorcycle serviced as soon as possible.

Oxygenated Fuels

Some conventional fuels blended with alcohol or an ether compound are available in some locales to help reduce emissions to meet clean air standards. These gasolines are collectively referred to as oxygenated fuels. If you plan to use oxygenated fuel, check that it is unleaded and meets the minimum octane rating and blend requirement.

The following fuel blends are EPA-approved and have been approved for use in your motorcycle:

- Ethanol (ethyl alcohol) up to 10% by volume.
 - ▶ Gasoline containing ethanol may be marketed under the name Gasohol.
- Methanol (methyl alcohol) up to 5% by volume that contain cosolvents and corrosion inhibitors to protect the fuel system. Never use a blend containing more than 5%.

If you accidentally fill your fuel tank with an oxygenated fuel containing higher percentages, you may experience performance problems. To resolve the problem, have your dealer drain the fuel tank and replace with the correct fuel. Fuel system or performance problems resulting from the use of an oxygenated fuel containing higher percentages are not covered by your warranty.

NOTICE

Improper use of oxygenated fuels can damage metal, rubber, and plastic parts of your fuel system.

Oxygenated fuel can also damage paint. Damage caused by spilled fuel is not covered by warranty.

If you notice any undesirable operating symptoms or performance problems, try a different brand of gasoline.

Authorized Manuals

USA The Service Manual used by your authorized dealer is available from your Honda dealer or Helm, Inc.

Canada See your dealer to order authorized manuals.

Also available, but not necessary to service your model, is the Honda Common Service Manual, which explains basic service information for various systems on Honda motorcycles, scooters, and ATV.

USA The Winter Storage Guide in conjunction with the Owner's Manual and Service Manual can help you prepare your Honda motorcycle, scooter, ATV, and SxS for winter storage.

These Honda manuals are written for the professional technician. However, if you possess the proper tools, observe the safety standards, and are mechanically capable, you should find them easy to use.

Special Honda tools are necessary for some procedures.

USA

Order On-Line: www.helminc.com

Order Toll Free: 1-888-CYCLE93

(1-888-292-5393)

(NOTE: For Credit Card Orders Only)

Monday - Friday 8:00 AM - 6:00 PM EST

Publication Item No.	Description
61K0A00	2019 CB300R/RA Service Manual
61CSM00	Common Service Manual
S9507	USA Winter Storage Guide
31K0AA00	2019 CB300R/RA Owner's Manual

Warranty Coverage and Service

Coverage

Your new Honda is covered by the following warranties:

- Motorcycle Limited Warranty
- Emission Control System Warranty
- **USA** Noise Control Warranty

The responsibilities, restrictions, and exclusions that apply to these warranties are explained in the Warranties Booklet given to you by your Honda dealer at the time of purchase. Always keep your Honda owner's card with your Warranties Booklet.

Canada Please refer to the Warranty Booklet posted on our website at www.honda.ca.

It is important to realize that your warranty applies only to defects in material or workmanship of your Honda. Your warranty coverage does not apply to the normal wear and deterioration associated with use of the motorcycle.

Your warranty coverage is not voided if you perform your own maintenance. However, failures that occur due directly to improper maintenance are not covered by these warranties.

USA You can extend almost all of your warranty coverage through the Honda Protection Plan. For more information, see your Honda dealer.

Service

Please remember that maintenance recommended in the Maintenance Schedule is not included in your warranty coverage. If you believe you have a problem with your motorcycle, call the service department of your Honda dealer. Make an appointment for an inspection and diagnosis. You will be asked to authorize that inspection, and your dealer will return the results of the inspection. If a problem exists and is covered under warranty, your dealer will perform the warranty repairs. If you have any questions about your warranty coverage or the nature of the repair, talk to the Service Manager of your Honda dealer.

If a misunderstanding occurs and you aren't satisfied with your dealer's handling of the situation, we suggest you discuss your problem with the appropriate member of the dealership's management team. If you are still not satisfied, contact the owner of the dealership or their designated representative.

Honda Contacts

American Honda Motor Co., Inc.

If you wish to contact Honda directly to comment on your experiences with your motorcycle or with your dealer, please send your comments to the following address:

Motorcycle Division,
American Honda Motor Co., Inc.,
P.O. Box 2200, Torrance,
CA 90509-2200
Mailstop: 100-4C-7B,
Telephone: (866) 784-1870.

Canada

Honda Canada Inc.
Customer Relations Department,
180 Honda Boulevard
Markham, Ontario
L6C 0H9
Telephone: (888) 946-6329
Fax: (877) 939-0909
E-mail: honda_cr@ch.honda.com

Please include the following information in your letter:

- Name, address, and telephone number
- Product model, year, and VIN
- Date of purchase
- Dealer name and address

We will likely ask your Honda dealer to respond, or possibly acknowledge your comments directly.

Your Honda Dealer

The service department of your Honda dealer offers trained personnel to perform regular maintenance and most repairs. It has the latest available service information from Honda and also handles warranty inspections and repairs.

The parts department offers Honda Genuine Parts, Pro Honda products, Honda Genuine Accessories (USA only), and Honda accessories and products (Canada only) that provide the same quality that went into your motorcycle.

USA The sales department offers the Honda Protection Plan to extend almost all of your warranty coverage.

Your Honda dealer can also supply information about, riding events, and information about safety training available in your local area.

USA Reporting Safety Defects

If you believe that your vehicle has a defect which could cause a crash or could cause injury or death, you should immediately inform the National Highway Traffic Safety Administration (NHTSA) in addition to notifying American Honda Motor Co., Inc.

If NHTSA receives similar complaints, it may open an investigation, and if it finds that a safety defect exists in a group of vehicles, it may order a recall and remedy campaign. However, NHTSA cannot become involved in individual problems between you, your dealer, or American Honda Motor Co., Inc.

To contact NHTSA, you may call the Vehicle Safety Hotline toll-free at:
1-888-327-4236

(TTY: 1-800-424-9153); go to
<http://www.safercar.gov>;

or write to:

Administrator, NHTSA,
1200 New Jersey Avenue, SE.,
Washington, DC 20590.

You can also obtain other information about motor vehicle safety from:

<http://www.safercar.gov>.

Specifications

■ Main Components

Overall length	79.5 in (2,020 mm)
Overall width	31.7 in (805 mm)
Overall height	41.3 in (1,050 mm)
Wheelbase	53.3 in (1,355 mm)
Minimum ground clearance	5.9 in (150 mm)
Caster angle	24° 44'
Trail	3.7 in (93 mm)
Curb weight	CB300R 313 lb (142 kg)
	CB300RA 317 lb (144 kg)
Maximum weight capacity *1	331 lb (150 kg)
Passenger capacity	Rider and 1 passenger
Minimum turning radius	7.5 ft (2.30 m)

*1 : Including rider, passenger, all luggage, and accessories

Displacement	17.4 cu-in (286 cm ³)
Bore x stroke	2.99 x 2.48 in (76.0 x 63.0 mm)
Compression ratio	10.7 : 1
Fuel	Unleaded gasoline Recommended: 86 PON or higher
Tank capacity	2.67 US gal (10.1 L)
Battery	YTZ8V
	12 V-7 Ah (10 HR)
Gear ratio	1st 3.416
	2nd 2.250
	3rd 1.650
	4th 1.350
	5th 1.166
	6th 1.038
Reduction ratio (primary / final)	2.807 / 2.571

Specifications

■ Service Data

Tire size	Front	110/70R17M/C 54H
	Rear	150/60R17M/C 66H
Tire type	Radial, tubeless	
Recommended Tire	Front	DUNLOP GPR-300F M
	Rear	DUNLOP GPR-300 M
Tire air pressure (Driver only)	Front	29 psi (200 kPa, 2.00 kgf/cm ²)
	Rear	33 psi (225 kPa, 2.25 kgf/cm ²)
Tire air pressure (Driver and passenger)	Front	29 psi (200 kPa, 2.00 kgf/cm ²)
	Rear	33 psi (225 kPa, 2.25 kgf/cm ²)
Minimum tread depth	Front	0.06 in (1.5 mm)
	Rear	0.08 in (2.0 mm)
Spark plug	SIMR8A9 (NGK)	
Spark plug gap	0.031 - 0.035 in (0.80 - 0.90 mm)	
Idle speed	1,400 ± 100 rpm	
Recommended engine oil	API Service Classification SG or higher except oils labeled as energy conserving or resource conserving on the circular API service label, SAE 10W-30, JASO T 903 standard MA, Pro Honda GN4 4-stroke oil (USA & Canada) or Honda 4-stroke oil, or an equivalent motorcycle oil	

Engine oil capacity	After draining	1.5 US qt (1.4 L)
	After draining & engine oil filter change	1.6 US qt (1.5 L)
	After disassembly	1.9 US qt (1.8 L)
Recommended brake fluid	Honda DOT 3 or DOT 4 Brake Fluid	
Cooling system capacity	0.83 US qt (0.79 L)	
Recommended coolant	Pro Honda HP Coolant	
Recommended drive chain lubricant	Pro Honda HP Chain Lube or equivalent	
Drive chain slack	1 3/16 - 1 9/16 in (30 - 40 mm)	
Standard drive chain	DID 520VF or RK 520KLO2	
	No. of links	108
Standard sprocket size	Drive sprocket	14T
	Driven sprocket	36T

■ Bulbs

Headlight	LED
Brake light/Taillight	LED
Front turn signal light	LED
Rear turn signal light	LED
License plate light	LED

■ Fuses

Main fuse	30 A
Other fuse	CB300R 10 A, 7.5 A
	CB300RA 30 A, 20 A, 10 A, 7.5 A

■ Torque Specifications

Front seat mounting bolt	7 lbf-ft (10 N·m, 1.0 kgf·m)
Fuel tank cover bolt A	3.1 lbf-ft (4.2 N·m, 0.4 kgf·m)
Fuel tank cover bolt B	3.1 lbf-ft (4.2 N·m, 0.4 kgf·m)
Fuel tank cover bolt C	7 lbf-ft (10 N·m, 1.0 kgf·m)
Fuel tank cover bolt D	7 lbf-ft (10 N·m, 1.0 kgf·m)
Fuel tank mounting bolt	9 lbf-ft (12 N·m, 1.2 kgf·m)
Outer shroud bolt	3.1 lbf-ft (4.2 N·m, 0.4 kgf·m)
Inner shroud bolt A	3.1 lbf-ft (4.2 N·m, 0.4 kgf·m)
Inner shroud bolt B	7 lbf-ft (10 N·m, 1.0 kgf·m)
Engine oil drain bolt	18 lbf-ft (24 N·m, 2.4 kgf·m)
Engine oil filter cover bolt	9 lbf-ft (12 N·m, 1.2 kgf·m)
Rear axle nut	65 lbf-ft (88 N·m, 9.0 kgf·m)
Front axle nut	44 lbf-ft (59 N·m, 6.0 kgf·m)
Front axle pinch bolt	18 lbf-ft (24 N·m, 2.4 kgf·m)

Information Record

VIN	
Engine No.	
Color Label & Code	
Owner's Name	
Address	
City/State	
Phone	
Dealer's Name	
Address	
City/State	
Phone	
Service Manager	

- A**
- ABS (Anti-lock Brake System) 11, 109
 - ABS (Anti-lock Brake System) Indicator 38, 109
 - Accessories 14
 - Air Cleaner 72
 - Average Speed Meter 19, 27
- B**
- Battery 61, 73
 - Brake Light Switch 92
 - Brake Light/Taillight 119
 - Brakes
 - Fluid 65, 90, 148
 - Pad Wear 91
 - Braking 10
 - Bulb
 - Brake Light/Taillight 119
 - Front Turn Signal Light 120
 - Headlight 119
 - License Plate Light 120
 - Rear Turn Signal Light 120
- C**
- Caring for Your Motorcycle 127
 - Catalytic Converter 139
 - Clip 75
 - Clock 19, 29
 - Clutch
 - Freeplay 98, 99
 - Clutch System 98
 - Coolant 67, 88
 - Coolant Temperature Gauge 19
 - Crankcase Breather 68, 102
 - Crash 5
- D**
- Digital Clock Adjustment 29
 - Document Bag 50, 126
 - Drive Chain 65, 94
 - Drive Chain Slider 97
- E**
- Electrical Trouble 118
 - Emission Control Systems 134

Engine

Number.....	133, 133
Oil.....	64, 84
Oil Filter.....	86
Overheats.....	107
Starting.....	45
Stop Switch.....	42, 126
Stopping.....	126
Will Not Start.....	106

Environment	132
--------------------------	-----

Equipment

Document Bag.....	50
Helmet Holder.....	49
Owner's Manual.....	126
Tool.....	50

F

Flooded Engine	45
Front Seat	76
Front Turn Signal Light	120

Fuel

Average Fuel Mileage Meter.....	19, 25
Consumption Meter.....	19, 26
Containing Alcohol.....	147

Current Fuel Mileage Meter.....	19, 25
Gauge.....	19, 110
Recommended.....	48, 147
Remaining.....	19
Tank Capacity.....	48, 147
Fuses	63, 121

G

Gasohol	140
Gasoline	48

H

Headlight	119
Headlight Aim	103
Headlight Dimmer Switch	42
Helmet Holder	49
High Beam Indicator	39
Honda Contacts	144
Horn Button	42

I**Ignition Cut-off System**

Banking Sensor.....	126
Side Stand.....	93

Ignition Key.....	125
Ignition Switch.....	43, 45, 126
Indicators.....	38
Information Record.....	150
Instruments.....	18
Instruments, Controls, & Other	
Features.....	126
K	
Keys.....	125
L	
Labels.....	7
License Plate Light.....	120
Load Limits.....	15
Loading Guidelines.....	15
M	
Maintenance	
Fundamentals.....	58
Importance.....	52
Record.....	57
Safety.....	53
Schedule.....	54

Maximum Weight Limit.....	15
Modifications.....	14
N	
Neutral Indicator.....	39
O	
Odometer.....	19, 21, 126
Oil	
Engine.....	64, 84
Overheating.....	107
Oxygenated Fuels.....	140
P	
Parking.....	12
Parts Location.....	16
Passing Light Control Switch.....	42
PGM-FI (Programmed Fuel Injection)	
Malfunction Indicator Lamp (MIL)....	38, 108
Protective Apparel.....	9
R	
Rear Seat.....	81
Rear Suspension.....	104

Rear Turn Signal Light	120	SET Button	18
Recommended		Shifting Gears	47
Coolant.....	67, 148	Side Stand	93
Engine Oil.....	64, 148	Side Stand Ignition Cut-off System	93
Fuel.....	48	SIDE STAND Indicator	39
Refueling	48	Specifications	147
Removal		Speedometer	19
Battery.....	73	Start Button	42
Clip.....	75	Starting the Engine	45
Front Seat.....	76	Steering Lock	44
Fuel Tank Cover Assembly.....	77	Stopping Engine	126
Fuel Tank Maintenance Position.....	79	Stopwatch	19, 21, 23
Rear Seat.....	81	Storage	
Shroud.....	82	Equipment.....	49
Repair Kit	111	Owner's Manual.....	126
Reporting Safety Defects	146	Tool.....	50
REV Indicator	33, 39	Storing	130
Riding Precautions	10	Switches	42
S		T	
Safety Guidelines	3	Tachometer	18
Safety Labels	7	Tachometer Display	37
Safety Precautions	9	Throttle	101
SEL Button	18		

Tires

Air Pressure	68
Puncture.....	111
Replacing	68, 111
Tool	50
Transporting Your Motorcycle	131
Tripmeter	19, 21, 126
Troubleshooting	105
Turn Signal Indicator	39
Turn Signal Switch.....	42

V

Vehicle Identification Number	133
--	------------

W

Warning Indicators On or Flashing	108
Warranty Coverage and Service	142
Washing Your Motorcycle.....	127
Weight Limit.....	15, 147
Wheels	
Front Removal	112
Rear Removal.....	115

⚠️WARNING

Operating, servicing and maintaining a passenger vehicle or off-highway motor vehicle can expose you to chemicals including engine exhaust, carbon monoxide, phthalates, and lead, which are known to the State of California to cause cancer and birth defects or other reproductive harm. To minimize exposure, avoid breathing exhaust, do not idle the engine except as necessary, service your vehicle in a well-ventilated area and wear gloves or wash your hands frequently when servicing your vehicle. For more information go to www.P65Warnings.ca.gov/passenger-vehicle.