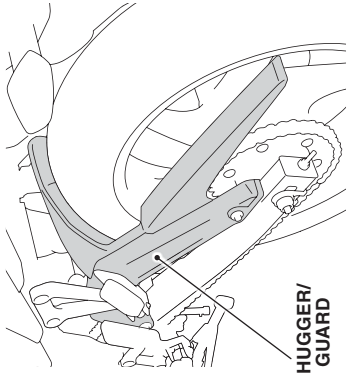
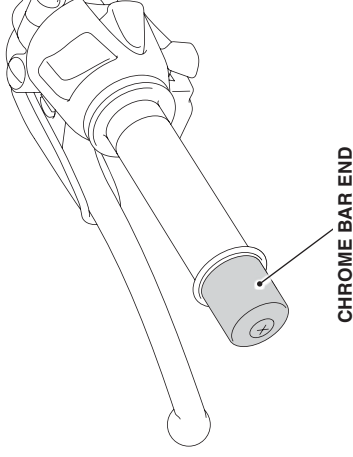

REAR HUGGER/CHAIN GUARD

- Check the accessory mounts frequently and retighten if necessary.
- Clean this accessory with a soft cloth soaked with a solution of mild detergent and water. Then wipe with a clean cloth soaked with water to clean dirt and detergent. Finally wipe dry with a soft, clean cloth.

**REAR HUGGER/
CHAIN GUARD****CHROME BAR ENDS**

- Check the accessory mounts frequently and retighten if necessary.
- Clean this accessory with a soft cloth soaked with a solution of mild detergent and water. Then wipe with a clean cloth soaked with water to clean dirt and detergent. Finally wipe dry with a soft, clean cloth.

**CHROME BAR END****UNDER COWL**

- Check the accessory mounts frequently and retighten if necessary.
- Clean this accessory with a soft cloth soaked with a solution of mild detergent and water. Then wipe with a clean cloth soaked with water to clean dirt and detergent. Finally wipe dry with a soft, clean cloth.

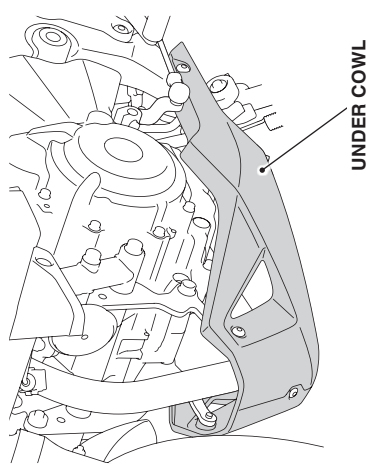
**UNDER COWL****HEADLIGHT LOWER COVER**

- Check the accessory mounts frequently and retighten if necessary.
- Clean this accessory with a soft cloth soaked with a solution of mild detergent and water. Then wipe with a clean cloth soaked with water to clean dirt and detergent. Finally wipe dry with a soft, clean cloth.

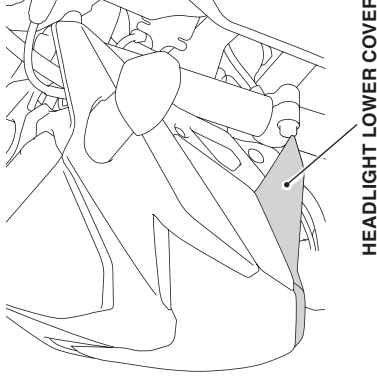
**HEADLIGHT LOWER COVER****PASSENGER SEAT COWL**

- Do not let anyone ride on the rear cowl and do not place luggage on it.
- Check the accessory mounts frequently.
- Clean this accessory with a soft cloth soaked with a solution of mild detergent and water. Then wipe with a clean cloth soaked with water to clean dirt and detergent. Finally wipe dry with a soft, clean cloth.
- Never use petroleum solvents such as gasoline, thinner or benzine to clean this accessory. Also do not use acid or alkaline cleaners.

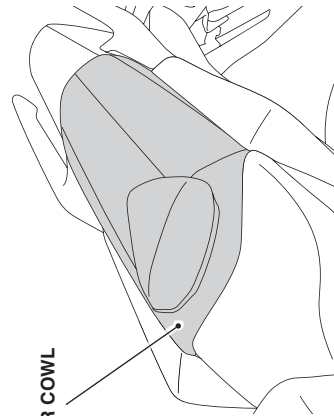
**REAR COWL**

CB300F/FA Genuine Accessory User's Guide

TAIL BAG

TAIL BAG

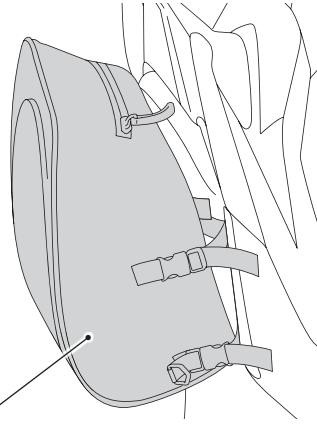

⚠ CAUTION

To prevent burns, allow the engine, exhaust system, radiator, etc., to cool before installing the accessory.

- The weight of the cargo must not exceed the following maximum loading capacity:

11.0 lb (5.0 kg)

- Do not let anyone ride on the tail bag and do not place luggage on it.
- Remove the rear seat bag from the motorcycle when not in use.
- Check the accessory mounts frequently.
- Clean this accessory with a soft cloth soaked with a solution of mild detergent and water or a cleaner.
- If this accessory becomes completely wet (water has soaked through the material), remove this accessory and allow it to air dried at room temperature. Never dry this accessory in a dryer, in front of a heater, or near a fireplace.

- Secure the right and left buckles as shown and tighten the straps while adjusting the balance between the right and left sides of the tail bag.
 - Tighten the front strap first and then the rear strap.
 - Secure well by pulling the straps tight.

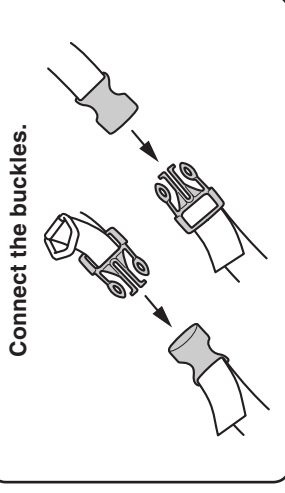
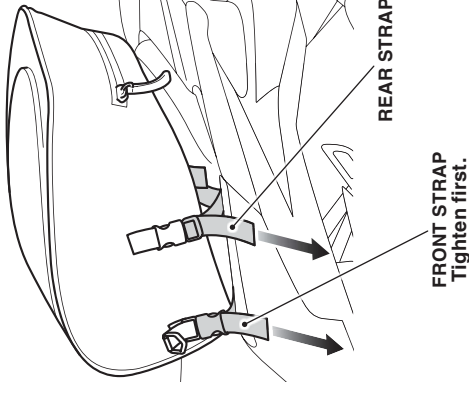

HOW TO INSTALL THE REAR SEAT BAG

- Remove the rear seat.
- Secure the rear strap to the rear seat as shown.
 - Secure well by pulling the straps tight.

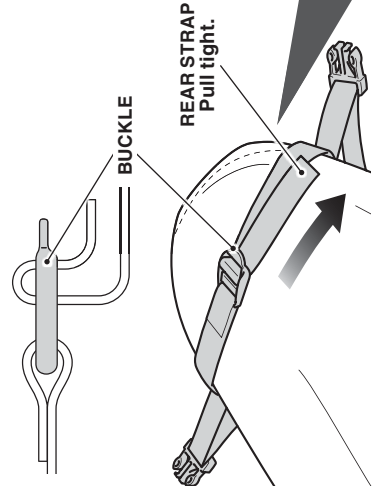

Install the rear strap in the position shown.

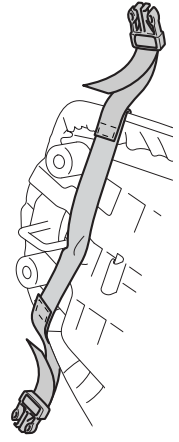

- Unlock the rear seat and insert the straps under the rear seat as shown.

- Lock the rear seat.
 - Make sure that the rear seat is locked securely.

REMOVAL

- Remove the rear seat bag in the reverse order of installation.

Continued

CB300F/FA Genuine Accessory User's Guide

SHOULDER STRAP

HOW TO USE THE SHOULDER STRAP

1. Hook the shoulder strap as shown.
 - Always store the shoulder strap when not in use.
 - Use the shoulder strap when carrying the tail bag.

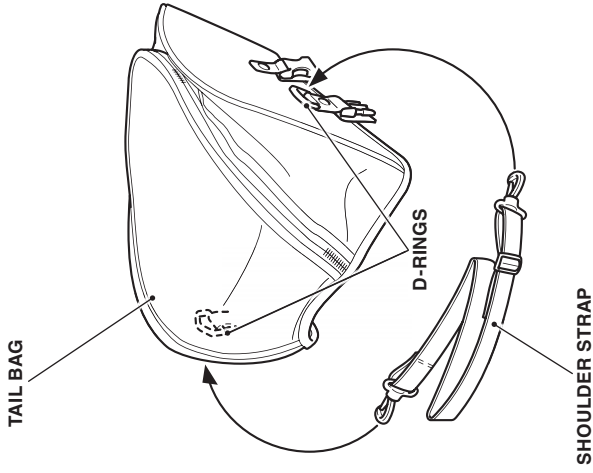

2. Put the rain cover on the tail bag as shown.

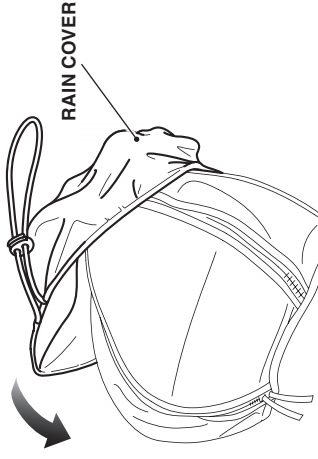

3. Fasten the hook of the rain cover as shown.

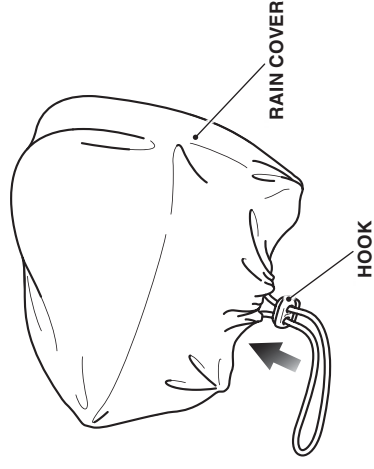

RAIN COVER

HOW TO USE THE RAIN COVER

1. Open the zipper and pull out the rain cover as shown.

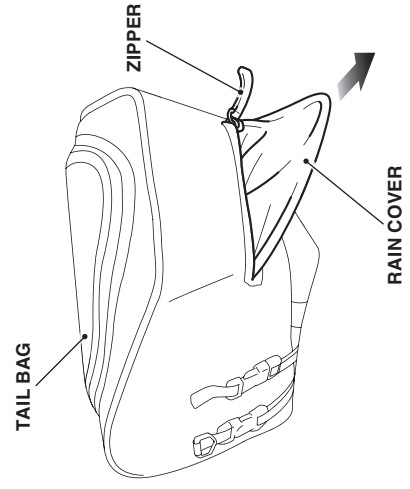

4. Put the string in the space between the rear seat bag and rain cover as shown.

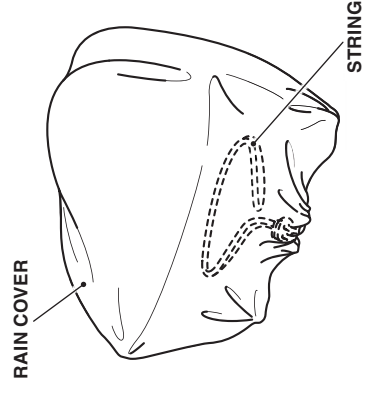

FRONT FENDER

TAIL BAG WHEN NOT IN USE

1. Remove the rear strap.
2. Put the front straps under the rear seat as shown and install the rear seat.
 - **Make sure that the front straps are under the rear seat.**

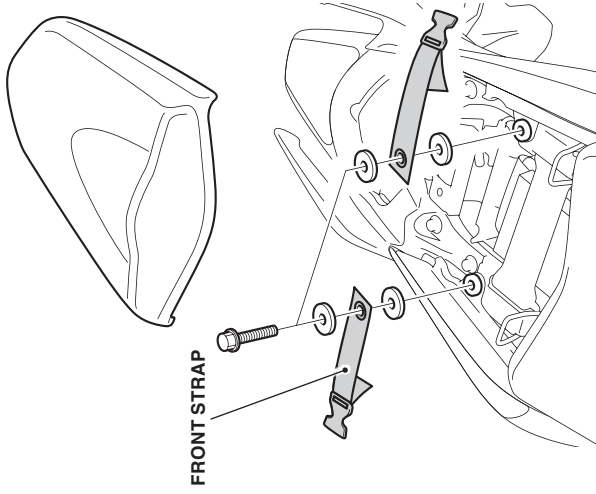

- Check the accessory mounts frequently and retighten if necessary.
- Clean this accessory with a soft cloth soaked with a solution of mild detergent and water. Then wipe with a clean cloth soaked with water to clean dirt and detergent. Finally wipe dry with a soft, clean cloth.

FRONT FENDER

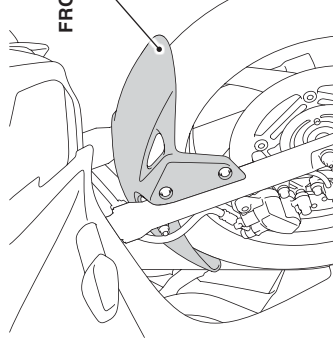

TANK SHROUD

- Check the accessory mounts frequently and retighten if necessary.
- Clean this accessory with a soft cloth soaked with a solution of mild detergent and water. Then wipe with a clean cloth soaked with water to clean dirt and detergent. Finally wipe dry with a soft, clean cloth.

